

Silent AC Power Anywhere, AnytimeSM

And we mean anywhere. **Heart Interface** offers an integrated system that includes an inverter/charger delivering reliable and dependable back-up power. Complete your electrical system with a **Heart Interface** Remote Control or LINK Battery Monitor that lets you know how much time you have left in your batteries. Call today or visit our website for a dealer near you.

Heart Interface / 21440 68th Ave. S. / Kent, WA 98032
Tel: 253-872-7225 / FAX: 253-872-3412
www.heartinterface.com

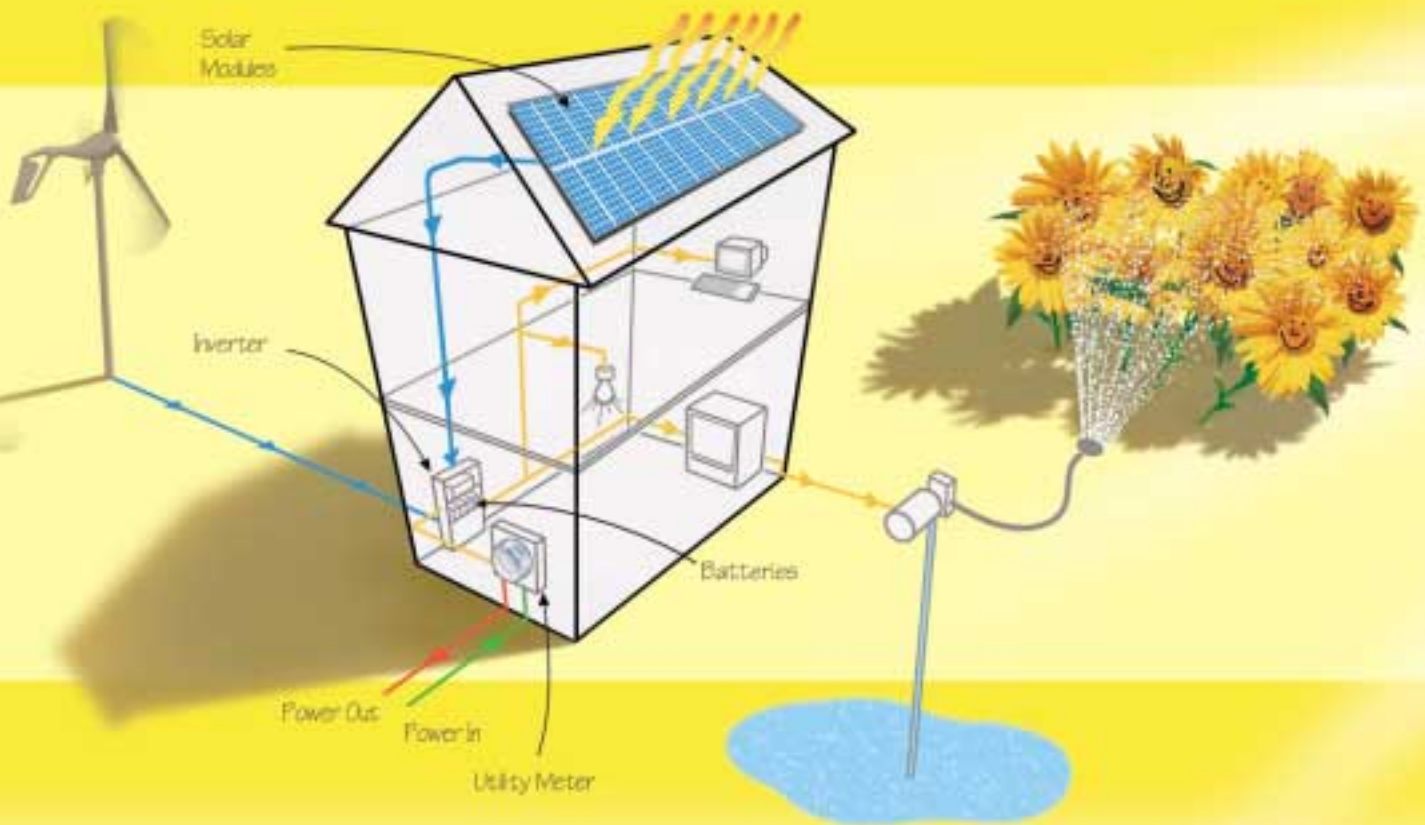

photo courtesy of ceder creek bed & breakfast. www.cedarcreektreehouse.com



BP SOLAR

*BP Solar: we're an advanced solar energy company. We manufacture premium solar modules and we're on the leading edge with new, low cost technologies. But we do much more...
We provide power solutions to enhance your quality of life and we have joined with industry leaders to bring you the best line of renewable energy products available, all backed by a name that is known and trusted throughout the world.*



USA:

American Energy Technologies, Ltd. - Florida
Toll Free: 800-874-2190
Phone: 904-284-0552
E-Mail: Solardell@aol.com

Dankoff Solar Products - New Mexico
Toll Free: 888-396-6611
Phone: 505-473-3800
E-mail: pumps@danksolar.com

Alternative Energy Engineering - California
Toll Free: 800-777-6609
Phone: 707-923-2277
E-mail: Energy@alt-energy.com
Internet: www.alt-energy.com

Effective Solar Products - Louisiana
Toll Free: 888-824-0090
Phone: 504-537-0090
E-mail: esp@effectivesolar.com
Internet: www.effectivesolar.com

Alternative Solar Products - California
Toll Free: 800-229-7652
Phone: 909-308-2366
E-mail: mark@alternativesolar.com
Internet: www.alternativesolar.com

Intermountain Solar Technologies - Utah
Toll Free: 800-671-0169
Phone: 801-501-9353
E-mail: utahsolar@aol.com
Internet: www.intermountainsolar.com

Talmage Solar Engineering - Maine
Toll Free: 888-967-5945
Phone: 207-967-5945
E-mail: tse@talmagesolar.com
Internet: www.talmagesolar.com





BP Solar, the world leader in solar electric systems, provides everything you need in a single package. And trained technicians from your BP Solar dealer can install the whole system in about a day, without disrupting your home or current electrical wiring. The BP Solar Electric Systems use "photovoltaics" or "PV" to convert sunshine directly into electricity. The power feeds into your home's existing electrical circuits energizing lights and appliances. Any extra power flows out to the power grid, actually spinning your utility meter backwards! For more information or the name of a dealer near you, just call one of our trusted partners listed below.

Reliable Technology From An Industry Leader

Business opportunities now available - join our team.



BP SOLAR

CANADA:

Powersource Energy Systems - British Columbia

Toll Free: 888-544-2115
Phone: 250-544-2115
E-mail: info@powersourceenergy.com
Internet: www.powersourceenergy.com

Solar Solutions - Manitoba

Toll Free: 800-285-7652
Phone: 204-632-5554
E-mail: solar@solarsolutions.ca
Internet: www.solarsolutions.ca

Powersource Energy Systems - Alberta

Toll Free: 888-544-2115
Phone: 403-291-9039
E-mail: info@powersourceenergy.com
Internet: www.powersourceenergy.com

Trans-Canada Energie - Quebec

Toll Free: 800-661-3330
Phone: 450-348-2370
E-mail: rozonbatteries@yahoo.com
Internet: www.worldbatteries.com

Powersource Energy Systems - Ontario

Toll Free: 888-544-2115
E-mail: info@powersourceenergy.com
Internet: www.powersourceenergy.com





HOME POWER

THE HANDS-ON JOURNAL OF HOME-MADE POWER

Issue #74

December 1999 / January 2000

Features

- 8** **Island Energy Microcosm**
Block Island, Rhode Island is off grid. The local on-island utility charges lots for their diesel-generated electricity. Thus, RE use per capita is high. Is Block Island a model for communities to come?
- 20** **Deregulation Catalyst in RI**
The Rhode Island Utility Restructuring Act has helped to jumpstart the solar industry.
- 24** **Solar Cells & Brain Cells**
Dick Anderson's Industrial Tech class at Scales Mound High in Illinois built a great mobile PV system for power on the go, and education too. Let's hope that these kids are our future.
- 34** **Rural Medical Power**
Agua Zarca, Nicaragua is a town of only 150 families, but the little medical clinic serves twelve other villages too. Two systems provide PV-powered lighting and vaccine refrigeration.
- 44** **Renew the Earth Institute**
The Midwest Renewable Energy Association (organizer of the biggest energy fair in the known universe) finally gets its own home. The new energy efficient and passive solar building is perfect for workshops, demonstrations, and RE chautauqua.



More Features

- 52** **RE System Data Logging**
With a PC, an E-Meter, and common software, you can log data and graph your system's performance just like the pros at NREL.
- 66** **Southwest Renewable Energy Fair**
The HP crew travels to Flagstaff, Arizona for this second annual fair—a fun event for the public and industry insiders as well.
- 74** **Wind Factory Tour**
HP visits the Southwest Windpower factory, where small-scale windpower is redefined.
- 94** **Wind Power Wrench**
Hugh Piggott is one of the few successful wind energy do-it-yourselfers. We question him on the secrets of wind genny design.

GoPower

- 60** **Solar Boats in Finland**
Olli Kuusisto and friends built solar-powered boats to cruise the beauty of the Finnish archipelago in clean, quiet peace.
- 104** **Batteries—Continued**
Part two of Shari Prange's exploration of EV batteries, and how to choose the right ones for you and your car.

Cover: Postmaster Fred Leeder with the 6 kilowatt PV array that powers the Block Island, Rhode Island post office.

More GoPower

112 Hybrid Hell?

Mike Brown calls "Reality check!" on the genset-in-the-trunk myth.

Guerrilla Solar

85 Guerrilla 0007

Twenty-four Siemens SR100 panels are the business end of this 48 volt guerrilla system. Cell by cell, the movement grows.

Homebrew

88 Y2K Disco Ball

The party won't stop at midnight if you build this Y2K compliant dance floor enhancement device. Designed by real electrical engineers, this high-tech unit can even be powered by your RE system.

Book Review

134 Going Underground

Want a cheap underground house? Mike Oehler's book tells you how. Check out this review by Don Kulha.

Columns

116 Word Power

Inverter: defined and described.

More Columns

118 Power Politics

'Round the world, the nuclear menace continues. And it's usually not the people who caused it who have to deal with it.

122 IPP

IEEE 929 and the utilities' attempt to restrict PV intertie systems with their own inability to provide clean power. Go figure.

128 Code Corner

Grounding your PV array when it's far from the rest of your system.

132 Home & Heart

Warming up to worms.

140 The Wizard

Global warming.

151 Ozonal Notes

Mule Power, and more.

Regulars

6 From Us to You

80 HP's Subscription Form

81 Home Power's Biz Page

137 Happenings—RE Events

142 Letters to Home Power

155 Q&A

157 MicroAds

160 Index to Advertisers

Access and Info

Access Data

Home Power
PO Box 520
Ashland, OR 97520 USA

Editorial and Advertising:
Phone: 530-475-3179
Fax: 530-475-0836

Subscriptions and Back Issues:
800-707-6585 VISA / MC
541-512-0201 Outside USA

Internet Email:
hp@homepower.com

World Wide Web:
www.homepower.com

Paper and Ink Data

Cover paper is 50% recycled (10% postconsumer / 40% preconsumer) Recovery Gloss from S.D. Warren Paper Company.

Interior paper is 50% recycled (50% postconsumer) RePrint Web, 60# elemental chlorine free, from Stora Dalum, Odense, Denmark.

Printed using low VOC vegetable based inks.

Printed by

St. Croix Press, Inc.,
New Richmond, Wisconsin

Legal

Home Power (ISSN 1050-2416) is published bi-monthly for \$22.50 per year at PO Box 520, Ashland, OR 97520. International surface subscription for US\$30. Periodicals postage paid at Ashland, OR, and at additional mailing offices. POSTMASTER send address corrections to *Home Power*, PO Box 520, Ashland, OR 97520.

Copyright ©1999 Home Power, Inc.

All rights reserved. Contents may not be reprinted or otherwise reproduced without written permission.

While *Home Power* magazine strives for clarity and accuracy, we assume no responsibility or liability for the use of this information.



Recycled Paper



Recyclable Paper

The Universe is a Grand Canyon



Karen, Michael, and Joe check their proportions at a very big place.

There are places where resident humanoids of Planet Earth can see and appreciate our proper proportion in this universe. The Grand Canyon is one of these places. Another is gazing into the starry night sky. Both show us the very small sphere of our awareness. We see miles and years. The universe does light years and eternities.

Let's face it. We are a barely aware lifeform inhabiting the third planet of a humdrum star in some galactic backwater of a universe of billions and billions of galaxies.

What makes life special is awareness. We are experiments in this universe's attempt to see, to feel, to appreciate, and to change itself. Let's see what we can do with this awareness...

—Richard Perez

People

Dick Anderson
Joy Anderson
Mike Brown
Sam Coleman
Kathy Dickerson
Chris Greacen
Jack Ihle
Anita Jarmann
Kathleen Jarschke-Schultze
Stan Krute
Don Kulha
Olli Kuusisto
Don Loweburg
Todd McLeish
Tim Nolan
Tehri Parker
Karen Perez
Richard Perez
Hugh Piggott
Shari Prange
Benjamin Root
Mick Sagrillo
Connie Said
Joe Schwartz
Erich Stephens
Michael Welch
John Wiles
Dave Wilmeth
Myna Wilson
Ian Woofenden

“Think about it...”

***Wake up to find out
that you
are the eyes of the world.***

—Grateful Dead

SolarSense.com

full page
four color
on negatives

this is page 7

Energy Microcosm:

A Small Island Looks at Renewables

Erich Stephens

©1999 Erich Stephens

As the Block Island ferry neared the end of its one hour voyage from the mainland and approached the island's shore, I spotted two 10 KW Bergey wind turbines. From this distance, they appeared to just barely poke above the treetops. I doubted any of the tourists on board even noticed the turbines, busy as they were taking in the beautiful view of Block Island's beaches, bluffs, lighthouses, farms, and old stone walls.

I was on my way to Block Island to look into a recent burst of renewable energy (RE) activity at this usually sedate vacation destination. Henry duPont, a local RE dealer/installer, put in the Bergeys a few years ago. Just before my visit, he had been awarded the largest of the Department of Energy's (DOE) Small Wind Turbine Verification Program grants. Chris Warfel, who runs an engineering consulting business on the island, was stepping up the marketing for another DOE grant that he is administering, designed to offset the use of fossil fuels on the island. And the local postmaster, Fred Leeder, was overseeing the fine tuning of the photovoltaic (PV) system recently installed at his Post Office—thought to be the largest grid-tied PV-powered post office in the country.

RE Central

Solar Works, Inc., an RE firm based in Vermont, designed and installed the Post Office system. As owner Leigh Seddon says, "Block Island is RE central for New England, if not the country. In fact, it's probably the best place in the country to test an RE grid. If it can't be done there, maybe it can't be done anywhere."

Located about 13 miles (21 km) from mainland Rhode Island, Block Island has about 1,400 homes. About 300 of these homes are occupied year-round. The island is served by the Block Island Power Company (BIPCO),



Solar-powered saltbox: old traditions blend with new on Block Island.

which is owned by four investors, and generates electricity using four large diesel generators. The need to truck in fuel via ferry, the utility's small size, and, according to some islanders, utility mismanagement, has resulted in BIPCO having one of the highest rates in the country—about 30 cents per KWH.

Moreover, these expensive kilowatt-hours are being produced using diesel generators which the Environmental Protection Agency says are in violation of the Clean Air Act. As a result, BIPCO (and presumably, BIPCO's ratepayers) are currently paying off a US\$90,000 fine, and the company is under a court order to install state-of-the-art pollution control devices on their generators.

Dorothy and Dan McCluskey are long-time PV users on Block Island.



Add to this a general desire to preserve the pristine nature of the island (over one-third of the land is protected by conservation agreements), a decent wind resource, and the energies of people like Henry, Chris, and Fred. The recipe is right for Block Island to show what the future of renewable energy could be, for better or for worse.

A Long History in RE

Block Island's place in the history of renewable energy was actually assured even before the current flurry of activity. In 1978, NASA was charged with using its aeronautical prowess to develop solutions to what seemed to be a dim energy



Sustainable harvest: Josie Merck's 10 KW Bergey flies over a hay field.

future. So they installed an experimental, commercial-scale wind turbine on Block Island. Henry duPont, a Block Island resident with a degree in Energy Management and Power, was chosen to manage the project.

According to Henry, the project was a technical success. It was designed to test various wind turbine technologies, and that's what it did. "We ran it fast, we ran it slow. We ran it with wood blades, we ran it with aluminum blades. We ran it forward, we ran it backward," says Henry. And when the testing was over five years later, the whole thing was offered to the local power company for a dollar.

The utility declined. It isn't clear exactly why. Henry points out that the turbine would have produced about eighteen percent of the island's electricity, meaning that the utility's fuel consumption would have dropped by about that amount. Interestingly, the utility was also in the business of importing fuel to the island.

The utility claims that maintenance of the unit was difficult for the NASA techies, let alone for a small utility, and that they were having trouble synchronizing the output from the wind turbine with the diesel generators. In any event, the unit was removed and scrapped. Regardless of whatever technical lessons might have been learned, the NASA turbine was definitely a public relations setback for wind energy in New England. Fifteen years later, many in the region still remember the Block Island wind turbine that "didn't work."

But Henry never lost his belief that RE sources could supply the island with clean electricity. During my visit, he gave me a tour of some of the island's RE systems he's installed since the NASA project. As is often the case, RE was first adopted on Block Island by homeowners living in areas not served by power lines. Henry estimates that there are about a dozen such stand-alone homes (including his own) on the island.

These homes are powered by PV and the occasional small wind turbine, usually of the sort typically found on boats. One home we visited, Dorothy and Dan McCluskey's, was a veritable museum of PV technology. Starting in 1982, every five years or so the McCluskeys installed a new array with the latest technology. They now have four different PV arrays of differing ages, and a pair of Ampair wind turbines, all on their lawn overlooking Great Salt Pond, Block Island's harbor.

As the cost of electricity from BIPCO continues to climb due to the court order, and as the cost of renewable energy sources falls, there is growing interest in grid-tied systems on Block Island. In fact, the two Bergey wind turbines I saw from the ferry turned out to be grid-tied.

PV-Powered Post Office

But the only PV grid-tied system so far is at the post office, strangely enough. But this shouldn't be surprising given that Fred, the postmaster, owns one of those dozen off-grid homes. Ironically, the fact that the Post Office took such a leading role on Block Island was the result of a small bureaucratic slip-up.

One day Fred received a form as part of an energy audit to reduce energy consumption at the Post Office. He dutifully counted light bulbs and whatnot, filled out the form, and returned it. The Postal Service then sent someone over to change out the bulbs to more efficient models and implement other conservation measures, which reduced energy consumption.

Later, Fred received the same form again. Not wanting to ignore the form, but certain that it was an oversight, Fred got on the phone with John Lovgren, the District Environmental Coordinator. After clearing up the matter,

John brought up the fact that the money source used to do the recent conservation work could also be used for RE projects. The catch was that the “payback” had to be under ten years.

Fred jumped at the opportunity, and worked with John to go through the calculations. As it turned out, even with the expensive electricity on the island, the numbers weren't quite there. But the Postal Service went ahead with the project anyway. “It was just the right thing to do,” says John, “we wanted to be proactive about the environment, and economically it might prove to be a smarter move than we appreciate right now. But even then, a lot of factors had to come into alignment, and having Fred on the scene was crucial for making everything fall into place.” Seventeen months after their initial phone conversation, thanks to John's support from the main office and Fred's local enthusiasm and knowledge, the switch was flipped to bring the system online.

“Nor Gloom of Night...” A 1,050 amp-hour battery bank and two Trace 4048 inverters provide backup power to the Post Office on Block Island.



Postmaster Fred Leeder with the 6 KW array at the Block Island Post Office.

The system has 6 KW of capacity, consisting of 20 ASE modules, ground-mounted alongside the loading dock. In standard mode, the system feeds electricity back into the Post Office's panel, reducing their load on the grid and saving them money.

The system is designed to provide 30 to 40 percent of the load, but Fred wants to get it up to 50 percent through his Yankee frugality. “I unplugged the water cooler, for example,” says Fred. “Come on, you can work without a water cooler!” During power outages, a 1,050 amp-hour battery bank will maintain the critical circuits needed for Post Office operations.

Fred says that the public's interest in the project has been wonderful. He often gets questions and words of support from his customers—everyone from kids to eighty year olds. The number of tourists passing through means that even more of the public is likely to see the PVs than if the project were done at another Post Office. Indeed, the DOE recently awarded the Post Office a grant to build a working model of the system to be displayed in the Post Office lobby, so that visitors can get a better understanding of how the system works.

“It really is an ideal site,” says Fred. “We had the space, we had the huge electric bills, and it serves as an excellent showcase.” In addition, although it doesn't take much time, not many postmasters have the knowledge or dedication needed to keep their PV systems in top form. Someday, running a PV system might be considered as much a part of the job as any of the other various tasks needed to keep a Post Office running. But until then, it's good to have postmasters like Fred around to show the way.

The Big Picture

While PV-powered Post Offices and off-grid systems

Block Island Post Office

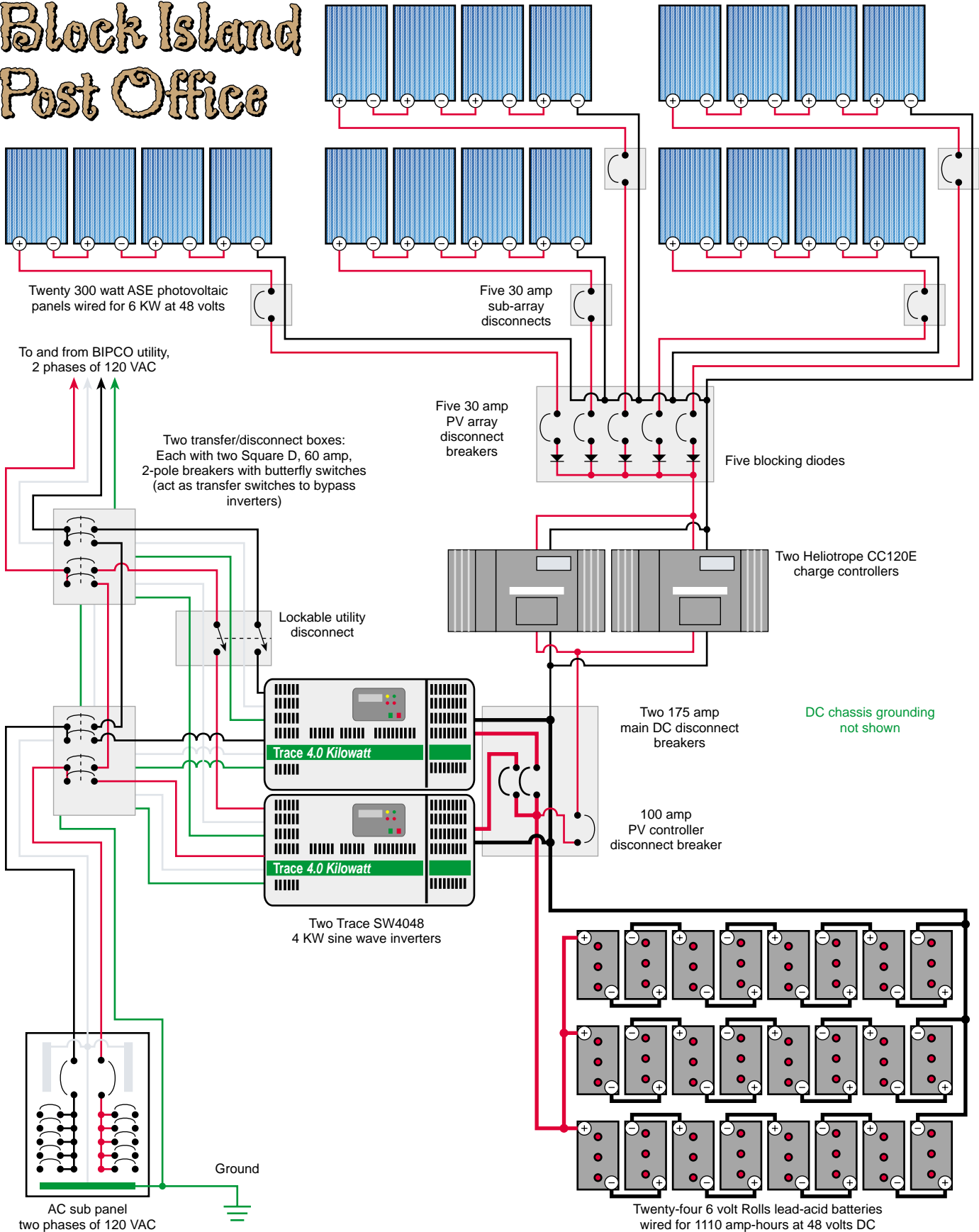

are all well and good, the future of RE on Block Island is being hammered out in two mundane offices. The first office belongs to the Block Island Power Company—BIPCO, and the second office belongs to Chris Warfel at the Block Island Renewable Energy Grant program.

In BIPCO's office, President Jerry Edwards told me that "net metering would be the beginning of a disaster" for the company. Jerry believes that net metering would mean that the utility would provide the same services to its customers as it does now, while receiving less revenue for doing so.

Not long after, Chris Warfel explained to me why he thought allowing net metering would be smart business on the part of the utility. Chris feels that the utility is overlooking benefits that net metering would provide to the utility, such as extra, non-polluting electricity being put on the grid.

There are several conflicting approaches for resolving Block Island's problem of expensive, polluting electricity. Which one is ultimately adopted will greatly affect the island's energy future.

There are two things that make BIPCO a little different from the many other utilities that are squeamish about net metering. First, facing increasing costs in order to comply with EPA regulations, the already high electric rates are sure to rise. At the same time, PV prices are sure to continue falling due to increased production and improved technology. This means that, relative to the rest of the country, it might not be much longer before PV-generated energy prices are cost-competitive with the utility's rates.

Second, given the small size of the BIPCO system, it's likely that a rather significant portion of their customer base would adopt net metering as soon as it makes purely financial sense to do so. BIPCO, like many utilities, argues that by allowing net metering, they are providing special services to RE system users, but aren't receiving any additional compensation. For example, net metering customers can cut their utility bills by selling power back to the utility whenever they happen to have electricity to sell—and not necessarily when the utility needs it.

Also, net metering customers can always count on the utility to provide electricity if the wind doesn't blow or if the sun isn't shining. While these services might benefit the net metering RE user, BIPCO argues that it doesn't really help the utility at all. Meanwhile, net meterers are getting these benefits of the utility grid while paying *less* to the utility than non-net meterers, who have no electricity to sell back. This means that while the net meterer is using the services of the grid more than the

Block Island Post Office System Costs

| <i>Item</i> | <i>Cost</i> |
|-----------------------------------|-------------|
| Modules | \$30,000 |
| Power center | \$8,500 |
| Mounts (rack, wire, installation) | \$6,000 |
| Batteries | \$4,500 |
| Installation (balance of system) | \$3,000 |
| Total | \$52,000 |

non-net meterer, the net meterer is actually paying less than the non-net meterer for the grid's services. In short, the utilities argue, net metering allows RE users to have their cake and eat it too.

Non net-metering customers, the argument goes, would have to pay more per KWH to cover fixed costs of operating the utility spread over fewer billable KWHs. Although the rest of the state benefits from one of the first net-metering rules in the country, Block Island was exempted, primarily for this reason.

The Value of RE

A petition drive to the public utilities commission (PUC) is underway to allow net metering on the island. But in the meantime, the utility pays home RE generators only what they are required to under federal law—the avoided cost of the utility's generation. Currently, the utility figures this to be about 11 cents per KWH. Some islanders are skeptical of this number. "I don't know where they got that number from," said a couple of RE dealers and users on the island. "They just came back and said, 'This is it.'" One person who took the trouble to look into it thought that 18 cents was a more accurate number.

Chris Warfel (a former utility engineer) and others argue that even if the utility were paying the correct avoided generation cost, it would still not compensate RE grid-connected systems for the benefits they provide. Solar and wind systems do not pollute, so they would even further reduce the pollution produced by the diesel generators at BIPCO, even after they've been cleaned up. What's the dollar value of this?

PV power is a peaking power—it often produces the most electricity at those times of the day when electrical usage is at a peak. Most of BIPCO's generating capacity is needed just to get through peak electric usage periods. About 50 percent of BIPCO's generation occurs during the four months of June through September. One measure of peak loading is already known to be twice that of mainland utilities. Chris Warfel asks, "Can RE be used to help manage the utility's peaks?"



Fossil fuel-free home: Postmaster Fred Leeder also powers his own home with wind, sun, and wood.

Distributed RE systems can reduce loads on overloaded distribution lines. Many of the islanders told me that brownouts are not uncommon—this is one of the reasons Fred wanted batteries at his Post Office. Also, BIPCO has done a lot of rewiring recently. Would it have been more cost effective for the utility to allow net metering instead, so that RE-powered homeowners would essentially have supported the grid for free? Would approaches like conservation measures, load management, and net metering to encourage home RE systems save consumers money over the utility's approach of buying expensive pollution control devices—and then passing the expense on to the ratepayers?

Unfortunately, it will probably be a while before Chris' questions get good answers. And a preliminary study by the National Renewable Energy Laboratory and Clean Power Research indicates that Chris is asking some good questions. The study found that conservation coupled with co-generation and RE sources was a more feasible approach than either cleaner gen-sets or a new submarine cable to supply the island, and that it warranted further study.

Chris told me that a block of money set aside to address some of these questions was allowed by the PUC to be diverted to a study of the proposed submarine cable to bring mainland electricity to the island. The cable was determined to be way too expensive, which surprised no one I talked to outside of

the utility. The money was used to study just one possible option for bringing in “cheap” electricity. So a chance has been lost to look at the bigger picture and learn something about the true costs of electricity on the island, and how those costs might be better managed.

Power to the People, Not the Lines

Meanwhile, Chris and Henry are betting that the island would in fact be better off with a distributed RE system, in which a central generation station is supplemented by RE sources scattered about the grid. Chris and Henry have pursued this goal down different avenues, and as a result they are involved with two separate grants from the DOE.

The DOE grant Chris is administering is designed to displace the use of diesel or gas fuels on isolated grids like Block Island's. The US\$379,000 grant, one third of the total awarded nationally, will cover 25 percent of the cost of PV, wind, and solar hot water systems installed on the island. Chris hopes the grant will result in up to 50 new RE systems on the island. This is the equivalent of about 15 percent of the island's year-round homes getting an RE system.

Henry is a lifelong resident of Block Island and something of an old salt (he makes a great quahog chowder), but he also happens to be an Ivy League educated expert in RE. The grant Henry's company received is designed to promote the use of small wind turbines, and will subsidize the installation of five more 10 KW Bergeys on the island.

Henry says that what the DOE really liked about his grant application was that he plans to actually test the benefits of distributed wind turbines on the island's grid system. Working with BIPCO, Henry will be able to measure the effect of one or more turbines at the ends of the utility's distribution system. If this test shows that the wind turbines help support the distribution system, it could be a powerful tool to RE advocates around the country for arguing that money should go to RE projects, and not power lines.

Rules regarding small wind turbines on Block Island are in place and quite reasonable. Any homeowner can put up a 60 foot (18 m) tower without special permission, as long as the tower is 60 feet from the property line.

There aren't a lot of tall trees on the island, thanks to a persistent, salty breeze, so 60 feet is often a workable (though perhaps not ideal) tower height.

Taller towers require a variance, but the two Bergeys already on the island received variances and stand at 75 and 80 feet (23 and 24 m). The towers and turbines must be painted a neutral color, can't have any lettering or drawings on them, and the owner must sign an affidavit that the turbines won't interfere with TV reception. That last item is a holdover from scares created by NASA's aluminum blades, and is no longer really an issue with today's wood and fiber blades.

Block Island's number one industry by far is tourism, so islanders are understandably concerned about not changing the quaint New England views on the island. Because of this, Henry feels that large, commercial-sized turbines would meet some public resistance. "At least while fuel prices stay low," says Henry. "As fuel—and therefore electricity—prices go up, people will think they are the most beautiful thing!"

In fact, some tourists seem to find wind turbines just as interesting to look at as the farms and ocean. The owner of one of the island's Bergeys rents out a nearby cottage to tourists during the summer. Henry says that the owner has received a number of letters from her renters saying how they were fascinated watching the turbine spin in the sea breeze.

Where To From Here?

The folks at BIPCO say that they are not opposed to renewable energy systems. Indeed, while none of the installers or owners I talked to reported BIPCO as being terribly supportive, they weren't calling BIPCO hostile or obstructionistic, either. To their credit, BIPCO's General Manager, Mike Wagner, has allowed Henry to set up temporary net-metering installations for demonstration purposes, and will be working with Henry on the study of the effects of a distributed wind system on the island's grid.

BIPCO also submitted a grant application to the DOE to use biodiesel in their generators, which would have turned their gen-sets into turbines powered in part by solar energy falling on midwestern farms. Unfortunately the grant was turned down for lack of funds, but they were encouraged to re-submit it.

Yet ultimately it is clear that what is good for BIPCO is not necessarily good for the island's ratepayers. BIPCO makes money by spending money to make electricity, and then charging its customers for it. There is little incentive for the company to promote conservation or distributed generation. Unlike generation companies in a competitive environment, they have little incentive to



Block Island's local RE dealer-installer Henry duPont, with his 850 watt Bergely.

keep costs down if their costs—and then some—will always be covered by the ratepayers.

Chris reports that a consultant hired by the town council to study ways to bring down the island's high electric rates recommended that the town own and operate the utility. This was seen as the best opportunity for bringing down rates and keeping them down.

Many RE supporters on the island feel that the utility is holding back the development of RE sources. But perhaps the residents and town leaders of Block Island could do more to help themselves—and their environment. I saw little interest in Henry's display of compact fluorescent light bulbs and other conservation devices at a small energy fair he held. These products are the single best way to reduce energy use—and the resulting pollution and expense. This is true in any setting, but especially in an area like Block Island with high electric rates.

As much as island RE advocates grumble about BIPCO's calculation for avoided cost they pay to RE producers, apparently none have asked the PUC to

look into the matter. Chris reports that most of the interest he has seen in the grant he's overseeing has come from people who only live on the island during the summer. Part of the reason for this is because summer residents generally have more expendable income, although discounted financing is available. But also, Chris feels, seasonal residents coming from more developed areas might be more conscious of the fragile nature of the island. So they put out extra effort to help protect it. Year-round residents might take the island's uniqueness for granted, and might not feel the sense of urgency seasonal residents do.

More involvement in the issue by the town government and residents as a whole could also play an important role in building a sustainable and affordable energy future for Block Island. For example, an excellent opportunity to foster the development of RE on the island was lost during settlement negotiations of the EPA's lawsuit against BIPCO. EPA regulators told me that they would have been open to a proposal from the town and/or BIPCO to use RE to offset generator use, but they never received any such proposals.

In fact, the utility did take a cursory look at wind turbines, wave power, and large-scale PV, but decided the politically expedient thing to do was to simply clean up the generators. Had the town pushed the utility to look at RE sources more closely, perhaps the upcoming rate hike would be funding clean sources of local power, and not "cleaning up" diesel generators that will continue to put island electric rates at the mercy of overseas fuel prices.

Compounding all of these problems is the usual petty politics and bickering of a small-town-on-a-small-island. The difference is, on Block Island, such pettiness could possibly ruin a wonderful opportunity to show the world the promise of renewable energy.

Despite its Victorian inns and 200-year-old farmhouses, Block Island might very well be the place to watch for a glimpse of our country's energy future. The island now has the opportunity to use RE technology to build an electric system that is both more robust and far less polluting than our current systems, and perhaps cheaper in the long run too. But will the people of Block Island follow the examples set by Chris, Fred, and Henry? Will they use the opportunity to enhance their island's economy, environment, and future? This remains to be seen.

Access

Author: Erich Stephens consults on RE projects in New England • 11 South Angell St. #195, Providence, RI 02906 • 401-952-7765 • Fax: 401-861-1113 erich@sventures.com

Block Island Power Company, 100 Ocean Ave., Block Island, RI 02807 • 401-466-5851 • Fax: 401-466-5068

Henry duPont, Offshore Services, Box 457, Block Island, RI 02807 • 401-466-2875 • Fax: 401-466-2909 offshore@wind-power.com • www.wind-power.com

Fred Leeder, Postmaster, Block Island, RI 02807 401-466-7733

Chris Warfel, ENTECH Engineering, Box 871, Block Island, RI 02807 • 401-466-8978 • Fax: 401-466-9827 cwarfel@entech-engineering.com www.entech-engineering.com

Solar Works, Inc., 64 Main St., Montpelier, VT 05602 800-339-7804 or 802-223-7804 • Fax: 802-223-8980 SolarVT@connriver.net • www.solarvt.com

Trojan L-16

**Low Prices, High Capacity
Delivered Anywhere**

Jesus said, "I am the way, the truth
and the life..." John 14:6



Maple State Battery
(802) 467-3662



New England

S O L A R H O M E S TM





Solar Farmhouse II TM

Standard Features
of a New England Solar Home

- Generous unobstructed south-facing roof area
- Passive solar configuration w/ deep roof overhangs
- Open light-filled interiors
- Standard & Custom Plans can be quoted for shipments of stress skin panel or pre-fab homes

Energy Self-Reliance

Suddenly Got a Lot More Attainable

All Climates/ Solar Home Design Company

For our free brochure contact us at:

New England Solar Homes

5 Jean Road
Arlington, MA 02474
Tel 782 646 6165 **Fax** 781 646 6188
Email solarhomes@ecobuild.com **Web** www.ecobuild.com

Plan Set Options:

- 1 Standard Plans
- 2 Std. Plans Customized
- 3 Full Custom

Call or write for price list.

plug into

POWER



FROM THE SUN, WIND & WATER

We're Your Resource for Home Power Equipment.



Call us for ONE STOP SHOPPING from our HUGE IN-STOCK INVENTORY. We're the #1 TRACE DISTRIBUTOR in the US with over 20 YEARS IN THE BUSINESS of serving you with GREAT CUSTOMER SERVICE. Our FREE TECHLINE is staffed by MECHANICAL and ELECTRICAL ENGINEERS. **CALL FOR OUR CATALOG: 1-800-777-6609.**

Dealer
Inquiries
Welcome.



Applied Power, formerly known as
**Alternative Energy
Engineering**
Solar, Wind & Hydroelectric Power Systems

It's Never Been So Easy To Install an

The \$35 Roof Mount Kit

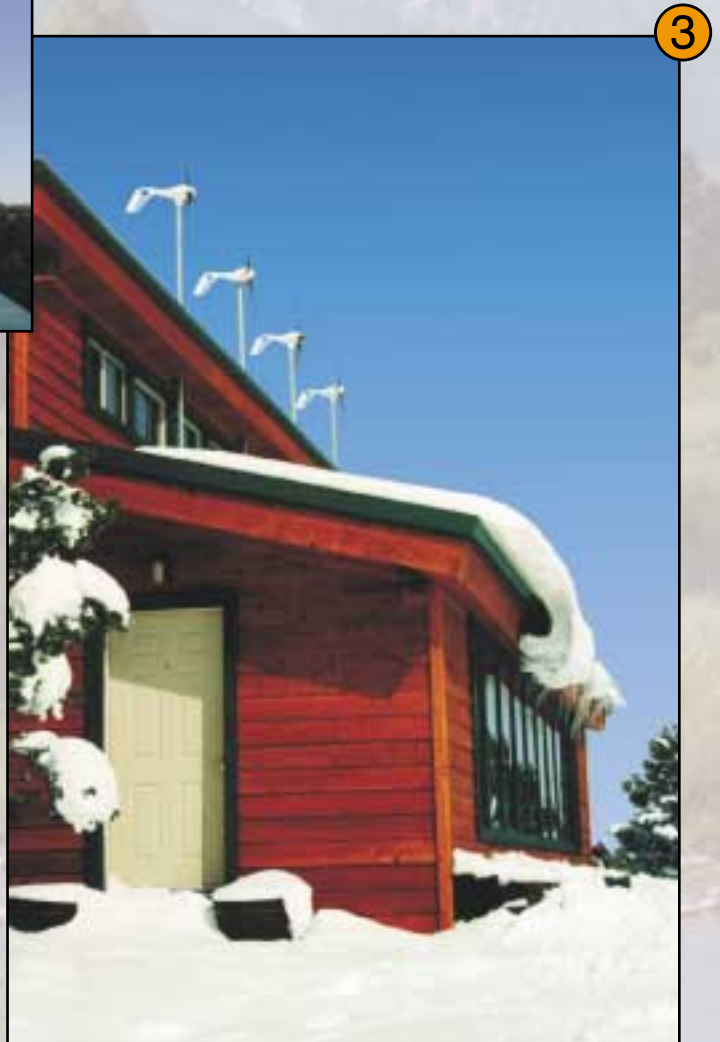

No room for a tower?

- × Simple roof top tower mount offers easy installation for your **AIR** wind module.
- × Design includes vibration isolation mounts that reduce mechanically transmitted noise by 80%.
- × Installs on the side of a building or through the roof.
- × Includes everything except pole and mounting bolts.
- × Roof seal sold separately.



Introducing the
ALL NEW
AIR TOWER™

**A Revolution in
 Tower Design**

**The \$54
 Tower Kit**

(27' tower)

Been thinking about an **AIR** wind module? Now is the time to get one (or several!)... Here is how it works:

From now until January 31, 2000, you can buy an **AIR** wind module together with a tower or roof mount kit for one incredible low price:

AIR Wind Module & 27' Tower \$649.00

AIR Wind Module & 45' Tower \$745.00

AIR Wind Module & Roof Mount \$630.00

Towers not sold separately during this offer.

- × Installs in a few hours.
- × No Cement.
- × No Gin Pole. (27' tower)
- × No Winching.
- × No Effort.
- × NO SWEAT!
- × Includes everything except pipe and anchors.
- × 45' tower kit includes gin pole hardware

For a dealer near you, contact:

Southwest Windpower

Renewable Energy Made Simple

2131 N. First Street • Flagstaff, Arizona 86004 USA
 Tel 520-779-9463 • Fax 520-779-1485
 www.windenergy.com • E-mail info@windenergy.com



1



2

Air Marine Shown



3

Air wind module mounted using the 45' tower kit

Deregulation Launches Solar Comeback in Rhode Island

Todd McLeish

©1999 Todd McLeish

While debate continues over who benefits the most from deregulation of the electric utility industry, proponents of renewable energy appear to be the big winners. In Rhode Island, the first state to open electric generation to competition, deregulation has already given the solar power industry quite a boost. If the Rhode Island program is used as a model by other states, it could signal a bright future for the renewable energy industry nationwide.

When Rhode Island's Utility Restructuring Act was signed by Governor Lincoln Almond in 1996, it included a provision designed to encourage the use of renewable energy (RE). Pushed by the Conservation Law Foundation and other environmental groups, the law established a statewide Renewable Energy Collaborative to develop RE projects. Funding comes from a small surcharge on all electric bills (amounting to

about one dollar per month for a typical residential customer) to be split among energy conservation programs and renewables.

"As a result of the legislation, the collaborative was formed to solicit ideas and review proposals for renewable energy projects," said Janice McLanahan, chief of energy and community services in the state energy office. "Funding has been secured for five years, and this is only year two, so we're still soliciting for future projects."

Members of the collaborative include the state's electric utilities—Blackstone Valley Electric, Narragansett Electric, Newport Electric, and the Pascoag Fire District—as well as the State Energy Office, the Public Utilities Commission, the Energy Council of Rhode Island (which represents industrial customers), and the Conservation Law Foundation.

"Since the state's electric companies were required to sell all their power plants to stimulate competition in the industry, we're no longer in the power generation business," explained Hank Sennott, spokesman for Newport Electric. "But we're still interested in helping our customers use energy efficiently and in an environmentally responsible way. Our involvement in the collaborative gives us a chance to help the renewable energy industry flourish here."

Project SunRise

The first proposal funded by the collaborative is a rooftop solar module program geared to residential and municipal buildings. Solar Works, Inc., a Vermont-based solar power consultant and contractor, was selected by the collaborative to implement the program, dubbed Project SunRise. Solar Works is responsible for marketing and installing the modules.

"Our first goal is to create a market for solar power in Rhode Island," explained Bob Chew, Project SunRise director. "Before this project came to the state, solar was something that most people thought had come and gone and was no longer a viable alternative. So our first job is to stimulate the market and let people know that solar is back."

Chew's marketing of the program goes in two completely opposite directions. In most of Rhode Island, where electricity rates are about 10 cents per kilowatt-hour and the modules he is installing have a 30 to 50 year payback, he is working closely with environmental groups, whose members are his most likely customers.

"Since these people already have a strong environmental conscience, I'm making them aware of the fact that there is a great economic and environmental price we pay for our continued dependence on fossil fuels," he says. "I also try to get them to think about changing the way they buy electricity. With solar, instead of buying electricity on a monthly basis from their utility, they're buying a 30 year block of electricity for a fixed price."

On Block Island, the sales pitch is completely different. There, electric rates are 30 cents per kilowatt-hour and the payback on Chew's solar modules is only about eight years. In this market, solar is economically competitive with the local utility, especially when you factor in such things as interest rates, inflation, projected electric rates, and the customer's electricity consumption. In addition, Block Island residents qualify for a 25 percent discount on the cost of a renewable energy system as a result of a grant the community received from the Department of Energy.

The System

Project SunRise offers photovoltaic (PV) systems in six different sizes, and uses both crystalline and thin-film technologies. The crystalline micro-inverter (MI) systems are the most compact solar generating packages installed. They are available in three sizes and include one or more PV modules and an inverter to create 120 volt AC power. On the 250 and 500 watt systems, the inverter is located on the back of the module, and a small power cord is connected from the

module to the building's load center. The MI systems use a state-of-the-art inverter from Advanced Energy Systems and a 4 by 6 foot (1.2 x 1.8 m) PV module that can be mounted on a roof, the side of a building, or on a ground rack.

For homeowners who want more power output than what is available from the AC modules, Project SunRise offers a larger MI system that generates 1,000 watts. The inverter for this system is usually located in the building next to the load center.

"We expect that most of the units we install will be the 500 and 1,000 watt systems," said Chew. Installed cost ranges from US\$2,800 for the 250 watt unit, which generates approximately 372 kilowatt-hours per year, to US\$9,370 for the 1,000 watt system, which generates nearly 1,500 kilowatt-hours. These prices include a discount from the sponsoring utilities.

Solar Energizer (SE) photovoltaic systems installed by Project SunRise range in size from 1,200 to 2,000 watts. They use the new Solarex Millennia thin-film modules, which are created through a new manufacturing technique that eliminates the need for individual crystal cells and solder joints. These systems can be roof or ground mounted and require from 340 to 550 square feet (30-50 m²) of sunlit area.

The SE units are connected to an Omnion utility-interactive inverter that converts the DC output of the solar array to standard 240 volt AC current. The inverter is usually mounted indoors, typically next to the household load center. These systems cost from US\$9,640 to \$12,630 installed, and generate from 1,787 to 2,978 kilowatt-hours per year.

For homeowners concerned about power outages, Project SunRise also offers several systems that provide emergency backup power.

Customer Response

Though Project SunRise is still in its infancy, it's already developing a strong following. J.R. Ouellette of Pawtucket had her 500 watt unit installed last fall, and it often generates more electricity than her household uses on sunny days. When it does, her electric meter turns backwards as her system returns electricity to the power grid.

Although her new PV modules cut her electric bill by 25 to 30 percent, that wasn't why she decided to go solar. Instead, she made that decision as a way of reducing her environmental footprint. "I just thought it was the proper thing to do," she said. "And their entertainment value is inestimable."

Mark Hopkins, a teacher at Woonsocket High School, is also excited about Project SunRise. He convinced Bob

Chew to donate a 250 watt unit to his school so he could use it as a teaching tool. It was installed on the school's roof last February, and Hopkins now uses it as a centerpiece in his technology curriculum. "With the electric meter located in my classroom and a special computer program, we're able to monitor the energy output from the panels and graph the varying amounts of energy being produced from day to day," said Hopkins.

More Renewable Programs

The Rhode Island Renewable Energy Collaborative isn't stopping with this one program. In addition to Project SunRIse, it is funding a study of wind power in the state. Endless Energy, a Maine-based wind power company, is investigating the potential for installing several wind turbines at various locations along the Rhode Island coast. Though the average wind speed at even the state's windiest locations is thought to be marginal, the company remains optimistic that it can find a buyer for its power and that the project will move ahead.

The collaborative has also committed to funding a solar program for commercial and industrial facilities, a solar lighting program, a landfill gas project, and the installation of fuel cells at a hospital and at the

University of Rhode Island. All are in varying stages of development.

"Rhode Island doesn't have much of a track record in the use of renewable energy," says Newport Electric's Hank Sennott. "But we now have the commitment and funding to make it work. It's a very exciting time here."

Access

Author: Todd McLeish, Blackstone Valley Electric Co.,
642 Washington Highway, Lincoln, RI 02865
401-333-8920, ext. 6184 • Fax: 401-333-6140
tmcleish@eua.com • www.eua.com

Rhode Island Renewable Energy Collaborative c/o Kate
Ringe-Welch, Narragansett Electric, 280 Melrose St.,
Providence, RI 02901 • 401-784-7348
Fax: 401-784-7257 • ringe@neesnet.com

Rhode Island State Energy Office, 1 Capitol Hill,
Providence, RI 02903 • 401-222-3370
Fax: 401-222-1260 • janicem@gw.doa.state.ri.us
www.riseo.state.ri.us

Conservation Law Foundation, 62 Summer St., Boston,
MA 02110 • 800-370-0697 or 617-350-0990
Fax: 617-350-4030 • www.clf.org

Endless Energy, 9 Castle Rd., New Gloucester, ME
04260 • 207-926-4698 • Fax: 207-926-3016
eec@ime.net



TROJAN BATTERY

four color on negatives

7.125 wide
4.5 high

Get **More** for Less



In just one year, these Solarex Millennia modules will have generated an amount of electricity equal to the energy used in their production. Note: Actual photograph of Millennia modules with patented Integra™ frame.

Thinking about an environmentally friendly solar electric system for your home?

Consider this—Solarex's new Millennia™ modules generate enough electricity in their first year of operation to offset the energy used to produce them.

While Millennia is generous in delivering electricity, it's a miser when using scarce resources. In fact, Millennia needs less than 1% of the silicon required to make equal-output crystalline modules. Also, Millennia modules don't contain potentially toxic or scarce materials.

Millennia by Solarex, the leader in solar electric technology for more than 25 years, offers an attractive appearance, greater efficiency, better stability than previous generations of thin film, as well as a choice of framing options for easy installation.

Millennia delivers all of this at a lower cost to the environment, and what's even better, a lower cost to you.

Millennia: *Proving you can get more for less.*

Contact Solarex today for more information.



It could take five to ten years for comparably rated monocrystalline modules to generate the electricity equal to that used in their production. Note: Computer simulation showing comparably rated monocrystalline system and its frame.



SOLAREX

The Natural Source for Electricity™

630 Solarex Court
Frederick, MD 21703
Phone: 301-698-4200
Fax: 301-698-4201
<http://www.solarex.com>
Info@solarex.com

From Solar Cells to Brain Cells—



Students Make the PV Connection

Dick Anderson

©1999 Dick Anderson

The completed Rolling PV Workstation. Posing with the fruits of their labor are Bret Hesselbacher, Mark Stadel, and Vance Koehler. Eric Czygan is not pictured.

As an Industrial Technology (shop) instructor at Scales Mound High School, I see a lot of curious and talented kids. When I started getting interested in renewable energy, it was a natural for me to apply that interest to my teaching job. After six months of working on this project, I find that my interest is contagious, and we're inspiring the next generation of RE fanatics.

Getting Inspired

After reading and drooling over *Home Power* magazine articles for several years, and attending a Midwest Renewable Energy Association (MREA) fair, I was hooked. In the summer of 1998, I attended a four day workshop sponsored by the MREA in Amherst, Wisconsin.

The class was taught by Jim Kerbel and Chris LaForge, two great spokesmen for PV. I liked it so much that I went back for the advanced five day course the following week. During the two classes, we studied and installed three complete photovoltaic (PV) systems on their model energy-efficient house at the fairgrounds in Amherst.

One system was a grid-intertie. It was a 48 VDC system, with sixteen PV panels mounted on a Wattsun dual-axis tracker. We used a Trace power module and C40 charge controller. Eight 6 volt lead-acid batteries were used for energy storage.

The second system was a 480 VDC grid-tie system which only sells power back to the utility. Twenty-eight MSX-56 panels were mounted on a 45 degree roof producing 1,568 peak watts! These panels were wired to an Omnicion 4 KW inverter. The power was then fed through a KWH meter to the utility grid.

The third system was a small 12 VDC stand-alone system very similar to our high school PV project. One twist in the MREA setup was that the four PV panels were mounted on a single-axis Wattsun tracker.

Taking PV Back to School

After taking the courses, I felt that there was a need to get PV education into the Scales Mound Industrial Technology curriculum. If students are going to accept and use PV in the future, they need to be exposed to the real thing in high school. What I had in mind was a PV system on wheels that we could work on in the shop and roll out into the sun for charging. Not knowing exactly what I was doing, I proposed the idea in my 1998-99 budget and the district approved US\$1,600 for the project.

I contacted Richard Perez at *Home Power* magazine, and class instructor Jim Kerbel. They looked over my rough plans and advised me on specific equipment that I would need. This help and advice was much needed and appreciated. Armed with refined plans, I did some serious catalog shopping and was stunned by sticker shock. Even the modest two PV panel, two battery, 500 watt system was about US\$2,500.

I told myself that this was not going to be a problem—it was going to be an opportunity! Like a bird leaping off the edge of the nest for its first flight, I wrote my first letters to RE manufacturers, asking for assistance. I explained my idea for a PV model on wheels that could be studied in the classroom and rolled outside for charging. I asked for advice on specific components, price discounts, or donations that would help make PV education a reality for my students. It would be the first of many successful flights over the next eighteen weeks! I cannot say enough about the help and support of the companies and people in the PV and PV-related fields—they were *great!*

Build for the Future

With the gathering of components underway, we began working on the nuts, bolts, and wheels of the system.

Starting from the bottom up, surgery was performed on the salvaged foundry cart. Salvaged heavy duty pneumatic wheels were attached to the front for steering. Riding lawn mower wheels were used on the rear.



The Rolling PV Workstation with 350 watts of PV deployed and soaking up the sun. Two Solarex MSX 64 poly-crystalline panels on top, two Solarex MST 40 LV thin film panels in the middle, and two Siemens SP75 single crystal panels on the bottom.

The students were eager to get started. We obtained an old foundry cart with steel wheels. The 2 by 4 foot (0.6 x 1.2 m) cart seemed pretty heavy, but would roll better on rubber tires. These we got from a casino change cart and an old riding lawn mower. Making some adjustments to the axle height, the cart was leveled up and we were set.

Jim Kerbel stressed that when building PV systems, you should “plan big and build for expansion; you will always want more power.” Keeping these words of wisdom in mind even though the original plan called for just two PV panels, we designed the PV rack to hold six modules. Thinking strength and not wanting to have students someday look outside and see a wind-damaged system, we built the PV rack and tilting system out of 1.5 inch (38 mm) square steel tubing with lots of bracing. The students had their first challenge designing the actual rack and positioning the PV supporting members to fit different modules. It wasn’t as easy as it looked. It was also intimidating for them because we didn’t have any panels yet and this was all on paper. But when we welded it up, we knew we would be stuck with it, and cutting and changing it would have been a real problem.

The same advice held for the vented battery box: build it big now. So we sized it to hold six batteries, even though the project plans called for just two. We ended up with four. Jim Kerbel was right on the money and the students learned why we built it so big in the first place—another good lesson learned.



The battery box in position. Sturdy uprights are braced to hold weight and resist wind forces on the PV rack.

We didn't have any batteries in the shop, so when we designed the battery box, the students made cardboard mock-ups of batteries. This really helped in setting clearance distances and positioning batteries so that the terminals were in good locations to wire for 12 volts. They had to consider dimensions of the battery, plastic battery box, 5/8 inch (16 mm) drywall lining, and 3/4 inch (19 mm) plywood. In future years, students will have to solve the same problem on paper, then check their figures and plans against the real box and see how they did. This is going to be a real problem-solving learning experience over and over again.

Cardboard Cutouts

Next we looked at mounting the various components, including the inverter, four fuse boxes, charge controller, battery monitors, and duplex outlets. The students groaned when I suggested that they make cardboard cutouts of each component and tape them on the mounting board. They wanted to use the real components and just screw them into place.

Not wanting to question their reasoning that it would be easier and faster, I gave them the inverter. I reminded them that it was worth US\$750 and that it would be damaged if they dropped it. I also gave them the 200 amp fuse disconnect box, all 30 pounds (14 kg) of it. It wasn't long before one of them pinched a finger in the hinge cover, and they said they would give cardboard a try.... After numerous placements and adjustments, we agreed on the layout and fastened the real components to the mounting board.

Time for Batteries

Our battery supplier offered to let the students come to their shop to cut and terminate the battery cables. This was a great opportunity for the students to work in the field with real battery experts. We loaded the battery box in a school van and set off for Dubuque, Iowa. Using the cardboard battery mock-ups, the students had determined the necessary cable lengths and gauge needed. They did this because in a real installation they may have to order terminated cables.

Our battery supplier had stressed safety, and supplied us with some very good information on working safely with batteries and recycling them. This was turning out to be a very well-rounded learning experience.

Following good safety practices, the wiring went well and we loaded the battery box (with batteries) back into the van with a forklift. We had a 45 minute drive back to school to think about how in the world we were going to get the 400+ pound (180+ kg) unit out of the van and onto the rolling PV cart. Luck was with us—the local lumberyard had a forklift and agreed to do the job.

Tools & Safety

Another safety step we took in this project was assembling a special tool kit for working on the PV system. All the tools were taped so that no metal except the tool end could make contact. This was something that Jim Kerbel and Chris LaForge stressed and insisted on.

A 6 by 8 foot (1.8 x 2.4 m) PV rack made out of 1 1/2 inch (38 mm) square tubing. Vance inspects the battery box.



Scales Mound High School Industrial Technology Program Rolling PV Workstation

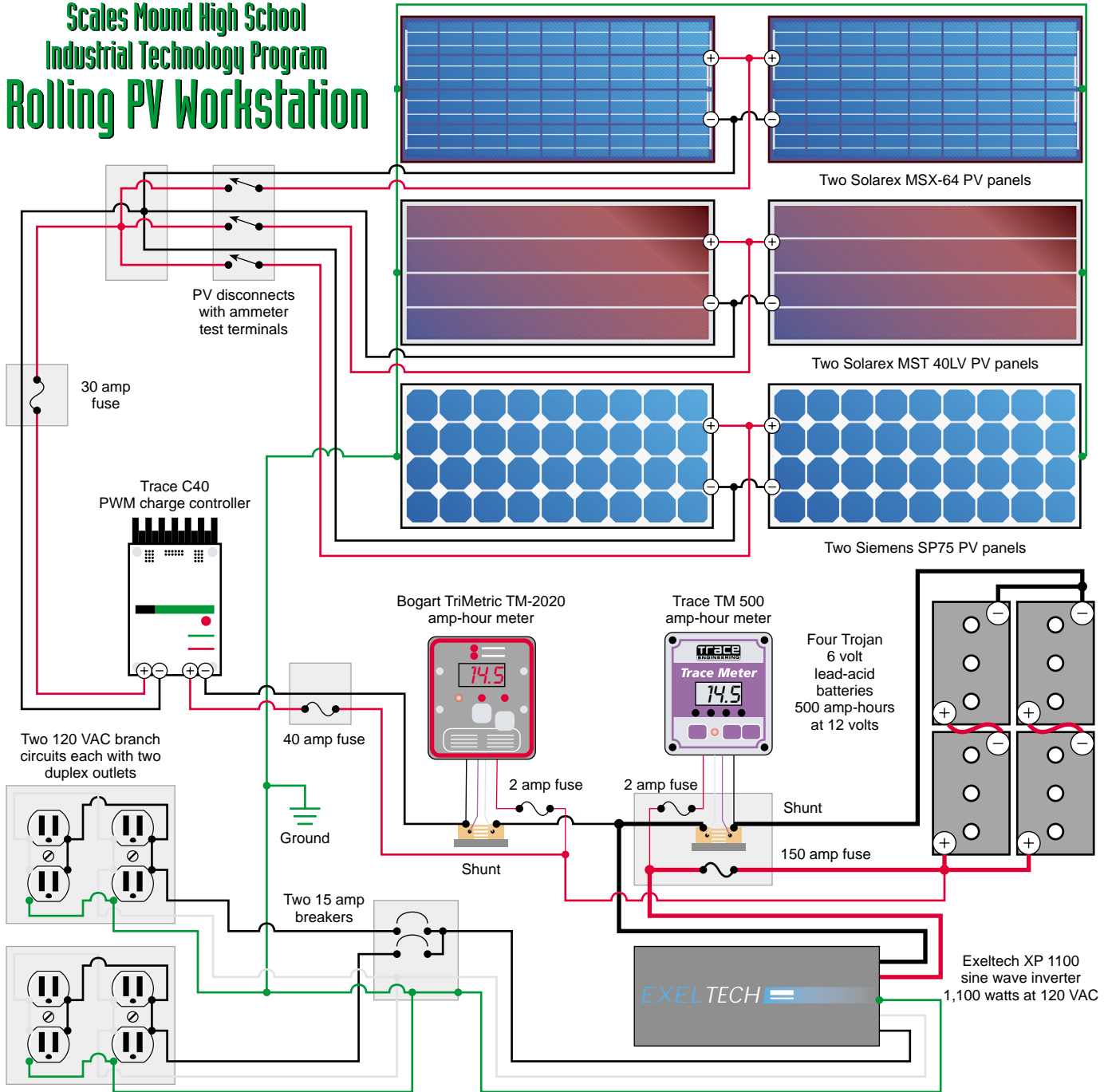

When assembling the tool kit, I also purchased safety goggles from the local hardware store. Never being one to pass up a bargain, I picked the lower priced goggles. When I got them to school, one of the students looked them over and read the warning tag on them. He pointed out to me that they were “not for use with chemicals.” This was a sure sign that there was learning going on. The students also noticed when I got the correct goggles.

Being in a school situation, we have an opportunity to really do things right the first time. For that reason we

added an eyewash station to the front of the battery box. Students noticed it right away and they got the safety message.

Putting It All Together

The six panels were in-house and ready to be mounted, and they fit the rack just as we planned. The students working on this project were in two different classes so they shared the work. Everyone got a chance to wire up a set of panels and struggle with blocking diodes in a panel J-box. When it came to routing the #8 (8 mm²) cable, that was an experience some didn't want!



Vance works under the watchful eye of Robert from The Battery Center in Dubuque, Iowa.

Students could see that good component layout really paid off in the wiring phase. Special attention was given to routing wire, leaving enough slack, and squaring up wire runs for neatness. Because it had to be just right, sometimes we had to do it over and someone else got some experience!

For the 120 volt AC output, we tried to simulate what a larger system would have. We installed a distribution box with two 15 amp breakers. Each breaker protects two duplex receptacles in a double gang box. This is much more than our 1,100 watt inverter can handle, but it lets us plug in a lot of small loads for experimenting.

We assembled a special set of taped tools to be used when working on the Rolling PV Workstation. All components and conduits were labeled—red lettering for danger, yellow for warning, and black for information.



Scales Mound High School System Costs

| # | Item | Price (US\$) |
|---|---|--------------|
| 2 | Siemens SP75 single crystal panels | 858 |
| 2 | Solarex MSX-64 polycrystalline panels | 818 |
| 1 | Exeltech XP 1100 inverter, 1,100 W, 12 V | 748 |
| 2 | Solarex MST 40LV thin film panels | 438 |
| 4 | Trojan batteries, 6 V, 250 AH, with cables | 407 |
| 1 | Trace C40 charge controller | 295 |
| 1 | Trace TM 500 monitor with shunt | 245 |
| 1 | TriMetric TM-2020 monitor with shunt | 194 |
| 1 | PV rack, 80 ft. of 1.5 in ² tube | 175 |
| 1 | Misc. wiring, conduit, & junction boxes | 163 |
| 1 | Todd 30 A 12 V battery charger | 155 |
| 1 | Fuse/disconnect for battery, 50 A (used) | 100 |
| 4 | Pneumatic heavy duty wheels (salvage) | 100 |
| 1 | AC breaker box with 15 A breakers | 60 |
| 1 | Foundry cart (scrap) | 50 |
| 1 | DC lightning arrester | 46 |
| 1 | Fuse/disconnect for solar panels, 30 A | 30 |
| 1 | Fuse/disconnect for controller, 40 A | 30 |

List Price Total **\$4,912**

Cost to School **\$1,600**

We have the three different panel types: polycrystalline, thin film, and single crystal. Having different panels lets students see the differences in output and other characteristics. We wired in individual switches for each pair of panels, plus ammeter probe points. The ammeter probe points were suggested by our electrical supplier, and allow the students to make easy comparisons. If you are considering building a PV system, your local electrical supplier will be an invaluable person to have on your team. Gathering all the parts for a small rolling PV system is very complex.

One of the final wiring steps was grounding the PV panels. Even though this rolling PV system would not be left outdoors, we wanted to simulate the real thing. Lightning strikes are real and they kill PV systems. We drove an earth grounding rod where the rolling cart is normally parked when collecting energy. We ordered a DC lightning arrester and it will be installed shortly.



Emergency eyewash—our battery supplier stressed battery safety.



Teamwork: Vance and Mark attaching the PV panels to the rack, taking care not to overtighten the bolts or strike the panels.

The system was completed about a week before the end of the 1998–99 school year, and we had a few days to collect sun and run a few tools and machines. We installed two battery monitors on the system, a TriMetric TM-2020 and a Trace TM 500. The Trace is wired to monitor battery state of charge, while the Tri-Metric is wired between the batteries and the C40 charge controller to measure input from the PV. Programming and understanding these monitors is proving to be a real challenge and learning experience.

I believe these monitors will be key to understanding and appreciating solar energy and batteries. You can see the students thinking when they plug in a light bulb and then an 800 watt toaster! When they see this 6 by 8

The PV junction box and two PV switch boxes. Meter probe jacks allow easy individual amperage readings.



foot (1.8 x 2.4 m) PV array producing only 350 watts, they can start to realize the huge amounts of energy we consume and take for granted. Then compare the cost of PV to US\$0.06 per KWH from the local electric company. But then, I don't think the first tractors were well received by farmers with horses either...

An Educational Need

The Rolling PV Workstation was designed to fit a need. Specifically, we wanted something that we could bring into the classroom for students to work on. We roll the station out on sunny days and monitor the charging of the batteries. When the station is in the shop, the students can study the construction and wiring, and perform lab experiments.

Bret wiring the AC distribution box. We installed two 15 amp circuits with four duplex outlets each.





The Rolling PV Workstation, happily soaking up the sunshine, so we can run some more equipment and experiment with the power from the sun.

One example is to draw power out using several standard incandescent light bulbs and then compare the power used with compact fluorescents. Another experiment will involve the football coaches' 12 cubic foot (1.1 m²) frostless refrigerator. We will run it on PV power and compare actual battery bank capacity to the students' sizing calculations.

We had a good time working on this PV project, and I want to thank all of the companies and people who made it a reality for my students. I'm sure it will be something they will always remember. If they build or use a PV system later in life, I'm sure they will remember and use this experience. We had some *serious fun* building this project. Thank you!

A close-up of the anchor pin and grounding wire for the system. The anchor pin is removable. The pipe it sits in is driven below the gravel to make it snowplow-proof.



Access

Author: Dick Anderson, Industrial Technology Instructor, Scales Mound High School, 210 Main St., Scales Mound, IL 61075
815-845-2215 • Fax: 815-845-2238
rca@scalesmound.net
www.scalesmound.net

Project Supporters & Donors:

- Scales Mound Administration and School Board; Scales Mound, IL
- Jim Kerbel, Photovoltaic Systems Co.; Amherst, WI
- *Home Power* magazine; Ashland, OR
- Exeltech; Fort Worth, TX
- Bogart Engineering; Boulder Creek, CA

- Trace Engineering; Arlington, WA
- Diamond Jo Riverboat; Dubuque, IA
- The Battery Center; Dubuque, IA
- Solarex; Frederick, MD
- Tuescher Electric; Darlington, WI
- Davis Supply; Scales Mound, IL
- Siemens Solar Industries; Camarillo, CA
- Alternative Energy Engineering; Redway, CA



SUNWEAVER

Design and Installation of Independent & Back-up power
Serving New England Since 1985



1-800-SUNWEAVER

Route 4 Northwood, NH 03261
Phone: 603-942-5863 ~ Fax: 603-942-7730
Web: www.sunweavers.com ~ e-mail: fonature@tiac.net

SIEMENS

Power anywhere.™



Siemens Solar.
So you can live
where you want.
How you want.
Call 1-800-947-6527
or visit us at
www.siemenssolar.com.

Siemens Solar
The Power to Live Anywhere

TRACE DEALERS
WIN A TRIP TO

HAWAII OR ST. CROIX U.S. VIRGIN ISLANDS

2ND PRIZE: P5 2512 INVERTER/CHARGER - VALUE \$2165.00
3RD PRIZE: A POWER TRACER METER - VALUE \$1240.00
4TH PRIZE: (3 WINNERS) TMS00 TRACE METER - VALUE \$245.00

WE'VE HAD A GREAT DECADE AND WE
COULDN'T HAVE DONE IT WITHOUT YOU.
TO EXPRESS OUR APPRECIATION WE
DECIDED TO END THE YEAR WITH A
BRAND NEW SALES PROMOTION EVENT.

FOR DETAILS CALL:
TRACE ENGINEERING
360-435-8826 X 2083
ASK FOR TRICIA



BOOST YOUR SOLAR OUTPUT

Maximum Power Point
Tracking Technology Can
Boost Your Solar Output
30% Or More!



- Patent Pending MPPT Technology extracts more power from your PV array.
- Advanced high efficiency power conversion technology delivers up to 30% more charge current to your batteries
- Superior PWM voltage control and available temperature compensation
- User friendly display monitors PV charge performance
- Solar Boost™ 2000 (20 amp 12V)

• **NEW Solar Boost™ 50 with multistage charging (50 amp 12V/24V)**

Our products are manufactured in the USA for the highest level of quality and reliability. Other products available include multistage AC chargers, inverters, solar panels and more.

Contact RV Power Products or a dealer near you. New distributors welcome.

RV POWER PRODUCTS
1058 MONTEREY VISTA WY
ENCINITAS, CA 92024

(800) 493-7877
(760) 944-8882



e-mail: info@rvpowerproducts.com/www.rvpowerproducts.com

"The output of a wind generator is primarily a function of its swept area. Rotor diameter, therefore, is a critical feature to help you compare one wind generator against another."

—Mick Sagrillo

Dear Friends of Renewable Energy,

THANKS EVERYBODY! All renewable energies had a record 1999. PV grew by over 30% and World Power Technologies grew more than 60%. Thanks to all the players who make up our renewable energy industry, especially the end users who demonstrate a renewable energy future to the world. We applaud the educational and forum value of *Home Power* to us all.

SIZE MATTERS! Most understand that the amount of electricity, kwh/mo (kilowatt hours per month), produced by a PV array is directly related to size of the collector area. Similarly, propeller swept area is the most important rating of a wind generator, because area determines and limits the amount of wind energy the machine can capture and turn into electricity.

NEW WHISPER RATINGS FOR 2000! World Power is renaming its wind generators by their propeller swept area. For example, our new Whisper 80 has an 80 square foot propeller swept area. It replaces our Whisper 1000 which had a 65 square foot propeller swept area. The kwh/mo energy increase is equal to the area increase. Our new product line features four propeller areas, each having twice or more the size of the next smaller model and producing twice or more the kwh/mo.

Current wind generator peak power ratings, at arbitrary wind speeds, bear little relation to kwh/mo electricity production. World Power now provides a power output rating at a more reasonable 10 meters per second (22mph) wind speed for comparison with other manufacturers.

We hope our changes help your understanding and lead to a better informed choice of renewable electric system.

Sincerely,

Elliott Bayly, President

WORLD POWER
T·E·C·H·N·O·L·O·G·I·E·S INC

ELECTRICITY FROM THE WIND & SUN

PHONE 218-722-1492 • FAX 218-722-0791

e-mail: sales@worldpowertech.com • web: www.worldpowertech.com

19 North Lake Avenue-HPS, Duluth, Minnesota 55802, USA

SIZE MATTERS

Twice the swept area means twice the electricity.
World Power wind generators are now identified by swept area.

New, user-friendly naming and rating system

H indicates 3 blades

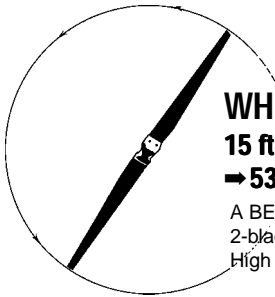

WHISPER 175 (Was WHISPER 3000)
15 ft diameter → 175 sq ft swept area
→ 538 kwh/mo* 2 blades

A BEST BUY for lots of electricity in a cost-effective, 2-blade design. Use for remote home or grid intertie. High voltage model for long distances.

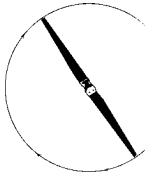

WHISPER 80 (Replaces WHISPER 1000)
10 ft diameter → 80 sq ft swept area
→ 222 kwh/mo* 2 blades

25% more electricity than Whisper 1000. ALL NEW design with silent, high efficiency, lifetime airfoil in our most popular size. Use for energy efficient homes. High voltage model for long distances.



WHISPER H80 (Replaces WHISPER H1500)
10 ft diameter → 80 sq ft swept area
→ 193 kwh/mo* 3 blades

Up to 40% more electricity than Whisper H1500 and back by popular demand. Featuring our NEW LOOK OF WINDPOWER with cast housing and black on stainless detailing. High voltage model for long distances. Direct AC water pumper coming soon!



WHISPER H40 (Replaces WHISPER H900)
7 ft diameter → 40 sq ft swept area
→ 105 kwh/mo* 3 blades

Our best-selling small home power generator is perfect for hybrid systems as well as telecom. Whisper quiet operation.



WHISPER H20 (Replaces WHISPER H500)
5 ft diameter → 20 sq ft swept area
→ 53 kwh/mo* 3 blades

Our smallest wind generator makes twice the electricity as the competition. Select the Whisper H20 when you need real power for your boat, cabin or telecom.



Other
7-11 sq ft swept area → 29 kwh/mo or less*

*12 mph (5.4 m/s) average speed

"Nothing says more about wind power than blade diameter. Nothing."

—Paul Gipe

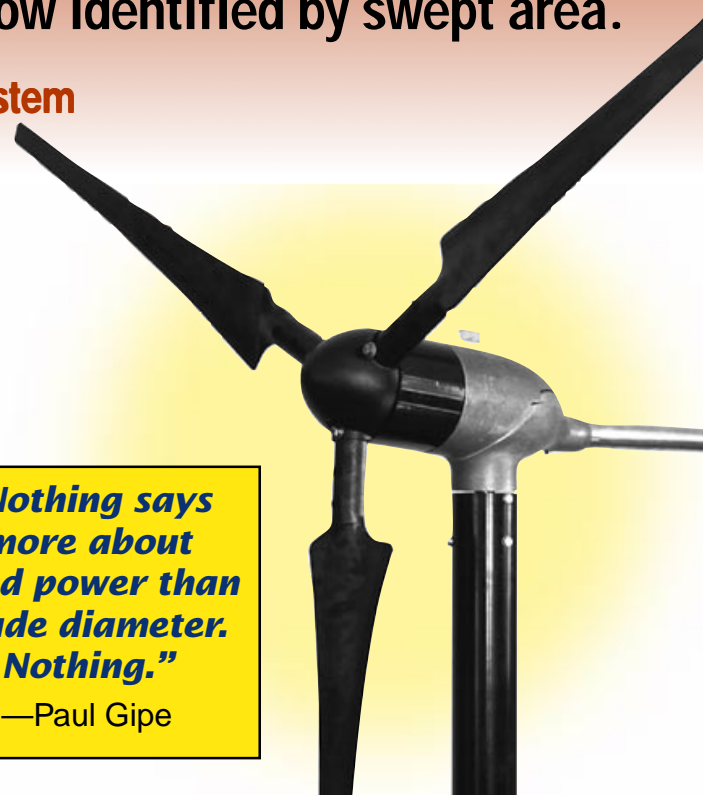

SELECT THE PROPELLER SWEEPED AREA FOR THE ELECTRICITY YOU NEED

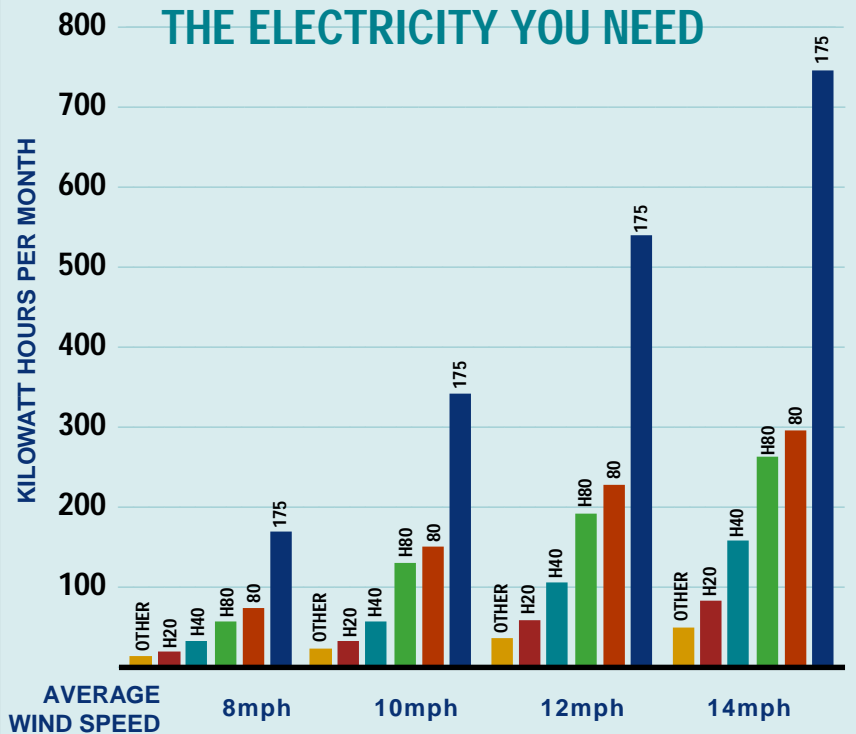

WORLD POWER
T·E·C·H·N·O·L·O·G·I·E·S INC
ELECTRICITY FROM THE WIND & SUN

19 North Lake Avenue—HPS, Duluth, Minnesota 55802, USA
phone 218-722-1492 • fax 218-722-0791
e-mail: sales@worldpowertech.com
web: www.worldpowertech.com

Solar Power & Rural Development

in Nicaragua

Kathy Dickerson

©1999 Kathy Dickerson

Agua Zarca women travel about two miles (3 km) roundtrip on the main road to fetch water.

Hurricane Mitch hit hard in the town of Agua Zarca in rural Nicaragua. It destroyed the crops which most people depend on for food and income. But in a country that continuously moves from crisis to crisis, Hurricane Mitch was not able to break the spirit that enables the people to endure hardship.

Following the hurricane, Agency for Environmental Health (AEH) installed a solar electric system in a health clinic in Agua Zarca. This clinic is the primary health center for not only the 150 families that live in the town, but also for twelve nearby communities.

Agua Zarca and surrounding villages are remote and do not have access to electricity. The solar electric system will improve health services by providing lights, vaccine refrigeration, and radio communication.

Non-Profit Agency

Agency for Environmental Health (AEH) is a non-profit organization that I founded in 1998 to improve human and environmental health in developing countries. This followed two years as a Peace Corps business volunteer in Nicaragua, and a summer of workshops in

solar, wind, and water power at Solar Energy International.

By updating health clinics with renewable energy (RE) technology, AEH helps to stop the vicious cycle of poverty, environmental degradation, and human sickness. It enables us to serve the most needy—those in rural communities. The solar electric system improves the services offered by the clinic and serves as a daily symbol and reminder of the sun's power. As this project succeeds, so does the notion that RE can be used for other community-enhancing projects.

Life in Rural Nicaragua

In my leisure time as a Peace Corps volunteer, I would hike through the mountains of Nicaragua. On these



trips I came across many rural villages. I was a novelty to the villagers at first. For some, it was their first encounter with a foreigner. What we might consider hardships are their everyday reality.

Women are physically challenged daily. Their day begins by cooking over a wood stove in close quarters. The smoke produced from the fire is thick at times and is inhaled by all family members, creating health risks. The women then make the trek to the community water source to haul water for the entire family. A large amount of water is needed for a typical family of five for bathing, cooking, and cleaning. The task of fetching water usually requires multiple trips, hauling 3 to 5 gallons (10–20 l) at a time.

The next few hours are spent cleaning and doing laundry. Laundry is washed on rocks at the nearest river, contaminating what may serve as their source of drinking water. Several hours are spent working in the fields with other family members to produce crops for food and income. At some point in the day, wood used for cooking must be gathered for the next day.

By evening, they are preparing dinner, which puts them back at the wood burning stoves, inhaling more smoke. After cleaning up, time is spent helping children with homework, preparing them for the following day, and putting away the laundry that is now dry. Rural life is physical for everyone. By the end of the day, the energy expended is sometimes more than the energy they get from the food they eat.

Homes are built from wood, mud, plastic, bamboo, or some combination of these materials. The houses are not sealed, and exposure to disease-carrying insects poses the risk of malaria, dengue fever, and chagas disease, among others. Latrines are a luxury that many households cannot afford, creating additional health risks.

Lack of technology and resources leaves these people repeating the same routines day after day. Introducing renewable energy can ease workloads by making daily tasks more efficient. RE technology can improve both their standard of living and their productivity in farming.

Project Components

First and foremost, the success of any development project depends on the community's *desire* for the project. The community must want to change and the project must allow the community to change in the

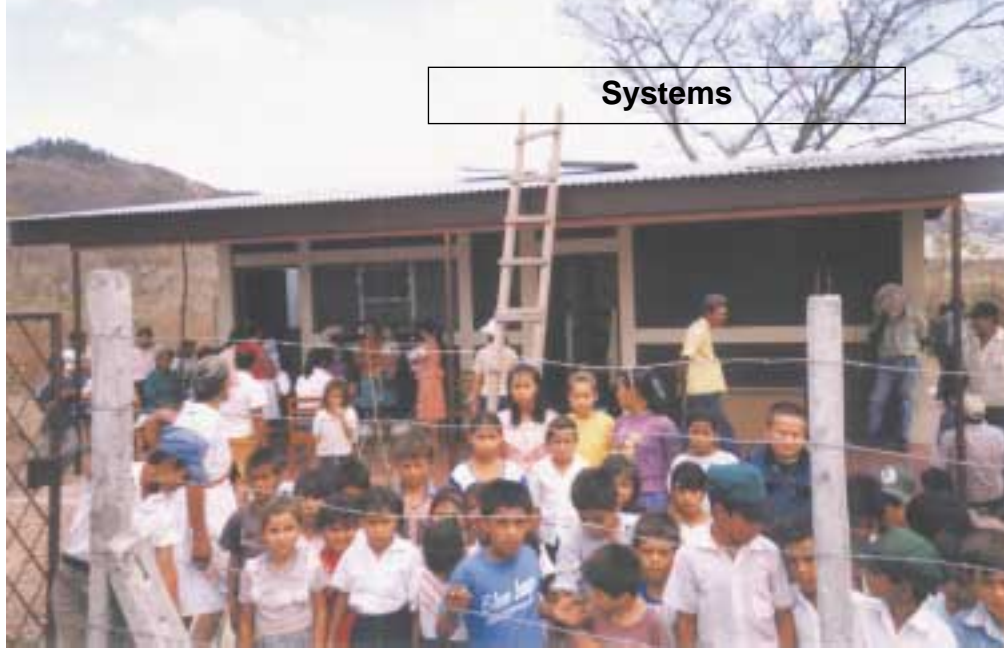

Agua Zarca's schoolchildren came out to learn about solar energy, and to observe the installation of their community's first electric system.

direction that they want to go. Sustainability of the project relies on local availability of materials and resources, local know-how, and community participation.

Local Materials and Know-How

Introducing technology to a poor country is not sustainable or long term unless materials are available locally and people know how the technology works. Local availability of materials ensures that replacement parts and components are accessible and affordable. Equally important, using local materials and labor contributes to the local economy. Supporting local industry is one way of insuring that materials will always be available. It also provides jobs.

The RE industry in Nicaragua is growing. ECAMI, S.A. is a private company based in Managua that has been in operation since 1988. They offer hydro, wind, and solar electric systems, as well as appliances and tools

ECAMI technicians Jairo Velazquez and Orlando Heradora supervised the installation.





Ministry of Health technicians Jorge and Rafael working side by side with community members.

for these systems. In the last several years, ECAMI has received grants for large-scale government and internationally funded projects.

Additionally, the UNI (Engineering University) in Managua offers a course of study and mini-courses about renewable energy. Susan Kinne and Richard Komp have been the driving force behind renewable energy education in Nicaragua (see *HP61*). Susan is working with FENIX, a group of students who manufacture a variety of solar panels, including solar charging stations for laptop computers. Nicaragua has both materials and know-how to implement and sustain current and future RE projects.

Ken Olsen, founding Director of Solar Energy International, has trained Ministry of Health technicians in the design and installation of solar electric systems for rural health clinics in Nicaragua. In fact, two technicians who attended his workshops—Jorge Herrera and Rafael Morales—both work out of the Ministry of Health office that services the region of Matagalpa. This is where AEH is working. Jorge and Rafael assisted ECAMI in the Agua Zarca PV system installation, and they will install future health clinic systems for AEH.

Community Participation

In any rural development program, the successful installation of solar energy in rural health clinics demands community participation. Our program is fortunate to have community support at two levels—the Ministry of Health and the rural villages. The Ministry of Health will be ultimately responsible for the repair, replacement, and technical maintenance of the system and its components. Their acceptance of this role and involvement in the process will strengthen their commitment to the success of the project.

The villages participate by demonstrating their interest and need. They also identify two members of the community who will be responsible for basic system maintenance, and they provide food and shelter to the installation team. This involves the community from start to finish, and they feel a sense of ownership in the project.

Initially, the community leaders are asked about the needs of their community clinic and how they feel energy could improve the services it provides. In this way, the community designs and sizes the system by identifying the loads it will support. A few eager citizens ask for X-ray and sonogram machines, but most are realistic in their request for clinic enhancement. The community of Agua Zarca identified the need for lights, vaccine refrigeration, and radio communication.

When I first met with Dr. Francisco Lopez, Municipal Director of the Ministry of Health, he was deeply concerned about Agua Zarca. The town is roughly 20 kilometers from the nearest urban hub via a road that is impassible during the rainy season. This means that five months out of every year, the town is isolated from outside help.

The women were just as interested as the men—Doña Reina receives system maintenance training.



Radio communication was immediately identified by the community members as a useful tool in the community. And the women were quick to request lights in the clinic. When a woman goes into labor after dark, the birth takes place by candlelight. While this can be perceived as quaint or tranquil to most of us, the lighting is not sufficient. In the unfortunate instances of complications, flashlights are brought out to improve visibility. The solar electric system will ensure that new lives will safely enter the village of Agua Zarca.

Additionally, Dr. Lopez asked AEH for the system to include vaccine refrigeration. The village is isolated for five months out of the year, so the benefits of having ready access to vaccines is obvious. But Dr. Lopez's request was more personal. The previous health worker was a hemophiliac and had severely cut himself several months earlier. Complications arose, and there was no way to maintain the refrigerated blood products he needed. The combination of no radio communication, no vaccine refrigeration, and being isolated from the nearest town with updated health facilities resulted in the man's death. Dr. Lopez wanted to ensure that a tragedy like this did not happen again.

Thanks to a small grant and charitable donations, AEH was able to provide the solar electric system. The Regional Office of the Ministry of Health agreed to provide the radio communication system. The donations included US\$3,000 cash from the Trull Foundation, a US\$1619 Sun Frost vaccine refrigerator (including shipping within the USA), and US\$152 from Grupo Taca for shipping the refrigerator to Nicaragua from the USA.

Systems Overview

All system loads are DC, eliminating the need for an inverter. The system can be modified later if additional medical equipment is desired by the community and the Ministry of Health.

Two separate systems were installed in the clinic. One system supports only refrigeration—an RFVB Sun Frost vaccine refrigerator, which draws 50 watts. The other system powers four fluorescent 20 watt Thinlite lights. A two-way radio will be installed on this system in the future. The entire concept of having electricity is new to the people in Agua Zarca. For some, this was their first encounter with electricity. The two independent systems will insure that there is always power for the vaccines, even if the other loads are overused.

Installation and Training

Prior to the system installation, I visited with the community to introduce the concept of solar energy. I explained how the system works by drawing schematics, detailing each system component and

Vaccine Refrigeration System

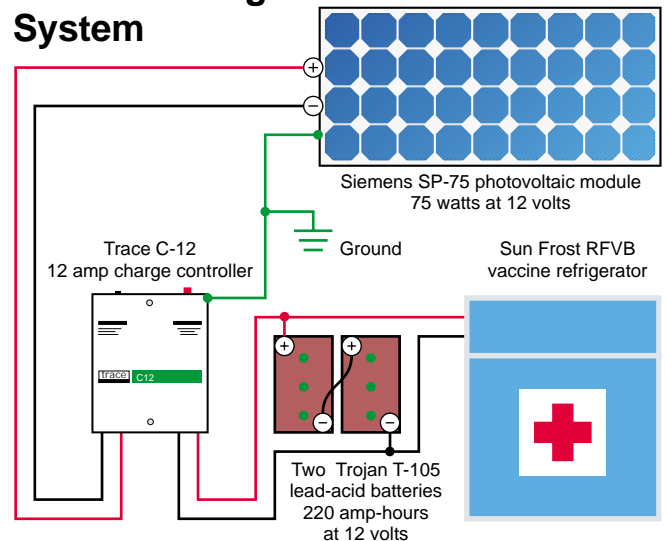

load. I also explained maintenance of the system and asked the community to select two people to be responsible for basic system maintenance. Women were encouraged to participate. In the case of Agua Zarca, two women, Reina Rodriguez and Marcia Ocampo, insisted on participating in addition to the three volunteer health workers.

Early on the installation day, only the Ministry of Health and ECAMI technicians and the three community health workers were on hand to begin the project. Slowly, people began arriving to watch. Before long, the men arrived to lend a hand and to learn about electrical systems! With the local expertise and community labor, the installation of the two systems took place in less than five hours.

Lighting & Communications System

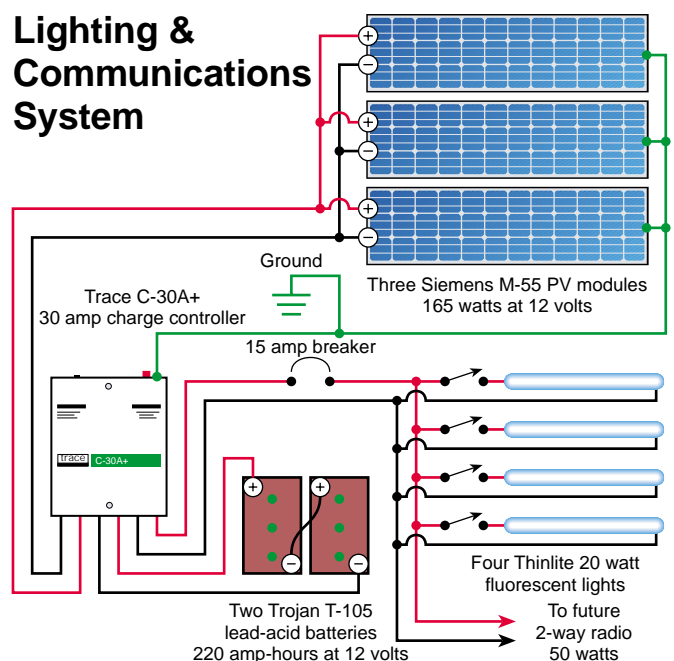

Throughout the day, community members stopped by to express their appreciation for our assistance. The women were just as curious about the system as the men. Given their equal stake in the health clinic, the women wanted to be included in the orientation of the finished system.

At one point, the professor of the village school brought his entire class out to observe the installation! This planted new seeds of learning in the youth of this town and gave us a chance to talk about the benefits of RE.

When we had finished the installation, Ministry of Health technicians Jorge and Rafael led a training session on system use and maintenance. Many community members participated, but the training was directed to the community health workers Francisco, Julio, and Luis; Dr. Francisco Lopez, Municipal Director of the Ministry of Health; Pedro Hernandez, Agua Zarca's mayor; and two women volunteers, Reina Rodriguez and Marcia Ocampo.

After four months of operation, the Ministry of Health in Matagalpa reported that the system is functioning perfectly, and that other rural clinic directors are requesting systems for their communities.

Obstacles

When we first went to the Ministry of Health to propose the project, we were told that solar energy doesn't work in Nicaragua. I personally had assisted in several solar energy installations when I lived in Nicaragua before, so I was familiar with potential problems. It was agreed that the main reason for unsuccessful solar electric projects is that no one checks the water level in the battery, and it subsequently dies.

Dr. Francisco Lopez, director of Municipal Ministry of Health (third from left), Pedro Hernandez, Mayor of Agua Zarca (second from left), and community volunteers who helped install the systems.



Agua Zarca Systems Costs

| <i>Vaccine Refrigerator System</i> | | |
|------------------------------------|-----------------------------|---------------------|
| <i>Item</i> | <i>Nicaraguan Cordobas*</i> | <i>U.S. Dollars</i> |
| Siemens 75 watt panel | 5,823.40 | 507.26 |
| Two 6 volt T-105 Trojan batteries | 1,837.76 | 160.00 |
| RFVB Sun Frost vaccine fridge | 26,986.84 | 2,350.77 |
| Trace C-12 charge controller | 1,066.13 | 92.87 |
| Misc. wiring, cables, & materials | 1,640.17 | 142.87 |

| <i>Main System</i> | | |
|-------------------------------------|-----------------------------|---------------------|
| <i>Item</i> | <i>Nicaraguan Cordobas*</i> | <i>U.S. Dollars</i> |
| Three Siemens 55 watt panels | 13,369.70 | 1,164.81 |
| Two 6 volt T-105 Trojan batteries | 1,837.76 | 160.00 |
| Four 20 watt Thinlite lights | 2,800.28 | 243.93 |
| Trace C-30A+ charge controller | 1,309.40 | 114.06 |
| Misc. wiring, cables, & materials | 2,257.43 | 196.64 |
| Labor costs for entire installation | 3,445.80 | 300.00 |
| Total (before 15% tax) | C\$62,374.67 | \$5,433.21 |

*Conversion factor: C\$11.48 = US\$1.00

This is where AEH's approach is different. It is vital to teach the community the importance of checking the water in the battery. The combination of working with trained technicians and setting a maintenance schedule for the two responsible parties will help form the habit of regular, basic system maintenance, thereby avoiding the problem.

The second problem involved the charge controllers. The Trace units we used for this installation only show when the batteries are charging and when it is completely charged. However, there is no way for the people to know when the batteries are low and energy needs to be conserved. This will be remedied in future installations by using a different model Trace charge controller.

Where We Go From Here

Agua Zarca is an arid region and the livelihood of the people is agriculture. Using RE for irrigation, milling, and grain drying could improve local production. This would increase both household food security and family income. In addition, women currently walk more than two miles (3 km) to fetch water. Community leaders have asked us to help them address this problem. Water pumping, solar cooking, and solar water disinfection are all projects we would like to initiate in Agua Zarca.



Community health workers Luis Castro, Julio Palacios, and Francisco Ruiz are part of the maintenance staff.

In addition, AEH is working to initiate an internship program between university students in the United States and their Nicaraguan counterparts. Together, these students can provide technical assistance to rural communities. The Agricultural Department of Louisiana State University and the Renewable Resources Department of University of Southwestern Louisiana have already expressed interest in involving their students in this program. We hope to secure funding for this program in order to present it to Nicaraguan students on my next trip down.

Renewable energy contributes to social and economic development. When people are healthier, they are more productive. When they are more productive, they can grow and harvest more crops, and bring them to market. Renewable energy can have a key role in this process.

When a community has better access to health care, the entire social foundation improves. AEH is fostering an understanding of the relationship between health and environment by implementing RE projects. This helps rural communities in developing countries have a chance at achieving healthier, cleaner, and more productive lives.

Get Involved

You can help make this a reality for underserved rural communities like Agua Zarca. In September, I went to Nicaragua with funding to install the same PV system in another rural health clinic. The system components were purchased from ECAMI to support local RE commerce. Jairo Velazquez, ECAMI's head engineer,

lead the installation team that included Ministry of Health technicians Jorge and Rafael. If you speak Spanish and have experience with solar cooking or other projects mentioned in this article, working vacations can be arranged. Monetary support is tax deductible. See our new Web site for other ways to become involved.

Access

Author: Kathy Dickerson, Director, Agency for Environmental Health, Inc., PO Box 850977, New Orleans, LA 70185 • 504-894-1411
aehngo@earthlink.net • www.aehngo.org

FENIX, Susan Kinne, Electrical Engineering Department, National Engineering University, Telcor Central Box #5595, Managua, Nicaragua
Telefax: 011 505 270 5125 • skinne48@yahoo.com

ECAMI, Luis Lacayo Lacayo, President, Apartado Postal 5547, Managua, Nicaragua
011-505-276-0252 • Fax: 011-505-276-0240
ecami@ibw.com.ni



MORNINGSTAR

BREITLING

Powered Around the World...

...by PROSTAR
The World's Leading Solar Controller

MORNINGSTAR CORPORATION Phone: 215-321-4457 • Fax: 215-321-4458
Website: www.morningstarcorp.com
1098 Washington Crossing Rd., Washington Crossing, PA 18977 USA



The Sunelco Team would like to wish all Home Power readers a Happy Holiday Season and a Prosperous New Millennium!

Free to Home Power Readers!



124 Pages of Answers!

Our publication begins with basic load analysis and sizing information and includes case histories, design guidelines and useful in-depth data required for system layout. It offers detailed descriptions of solar components and packages. A must for every energy library!

At Sunelco we pride ourselves on the quality of our performance and the integrity of our Systems Designs. Because we are a part of the Kyocera Solar team we can offer you the finest that the Solar Industry has to offer

- The highest quality solar modules in the industry.
- The best warranty in the industry. . . **25 years!**
- The largest inventory of modules and Balance of System components available.
- People you can trust - Talented, professional and courteous.
- We live with the products we sell.
- 24 hour shipping on in-stock merchandise.

What this means to you is . . .

Small Company Service — Big Company Guarantee!



A DIVISION OF KYOCERA SOLAR

100 Skeels Street • P.O. Box 787 • Hamilton, MT 59840

Shop On-line at: www.sunelco.com

1-800-338-6844



WE'VE PUT THE POWER... ON YOUR DESKTOP

POINT, CLICK, LEARN, DESIGN, ANALYZE,
COMPARE, AND BUY WISELY.

NO ENGINEERING DEGREE REQUIRED!

BERGEY • DIRECT

Contents

- About Bergey
- Latest News
- 90 Second Expert
- Tutorials & FAQ's
- Products & Services
- Value Packages
- Wind Maps
- Feasibility Study
- Economics Study
- System Design
- Purchase Options
- On-line Ordering
- Certified Dealers
- Resellers
- Tech. Manuals, Etc.
- Installation Process
- Search the Site
- Library & Links
- Jobs & Opportunities

MAKING A DIFFERENCE

BERGEY WINDPOWER

Clean renewable power for homes, villages, farms, and remote sites

Bergey Windpower is the world's leading supplier of small wind turbines. We were established in 1977 and now have installations in all 50 U.S. States and over 90 countries. We take pride in offering products that let homeowner's run their utility meter backwards or that can bring electric power and modern services to remote areas.

SIMPLICITY • RELIABILITY • PERFORMANCE

"How can we help you today?"

Mike Bergey
President & CEO

- I want to learn about the California and Illinois Rebates
- We want to reduce our utility bills
- I need power for a remote home or village
- I need reliable power for a communications site
- I want to learn more about wind power
- I hate my power company
- I want to help the environment
- I need power to pump water for drinking or crops

WWW.BERGEY.COM



2001 Priestley Ave.
Norman, OK 73069
T: 405-364-4212
F: 405-364-2078
SALES@BERGEY.COM
WWW.BERGEY.COM

SEEKING NEW DEALERS TO HARVEST THE SUN



1-800-229-7652
Fax 909-308-2388

27420 Jefferson #104B
Temecula, CA 92590

E-mail: mark@alternativesolar.com

Visit our website:
www.alternativesolar.com

- We are currently welcoming applications for our BP Solar Dealer Network
- Complete dealer support: engineering, marketing, sales leads, knowledgeable staff
- Single line solar distribution - Offering the world's most efficient solar modules by BP Solar
- Join the fastest growing team of successful renewable energy dealers in the world
- Pre-engineered Utility Interactive Systems

Huge inventory
supplies!



Trace Engineering



Pulse



Specialty Concepts



Heart Interface



SouthWest
Windpower



BP Solar

EASY CHOICES

Solar Cells

AstroPower's high-efficiency five inch and six inch single crystal solar cells are the largest and most powerful solar cells on the market today. With rated power of up to 3.5 watts, these solar cells extend the unparalleled performance history of single crystal silicon into unprecedented new sizes for the best solar cell value around.



Large Area Panels

Building a large array? AstroPower's large area panels give you the biggest increment of pre-tested, pre-wired PV power available today – up to 480 watts per panel. Shipped to the site in reusable shipping racks, these panels will get you into production significantly faster and less expensively than using individual modules.



PV Modules

AstroPower's PV modules are available with rated power from 30 watts to 120 watts. The perfect solution for applications ranging from remote home power to professional applications such as telecommunications, AstroPower modules carry a 20 year warranty, and are certified to both UL 1703 and IEC 1215 standards.



APex™ Technology

Our new APex™ products are made using a revolutionary new continuous high-speed process called Silicon-Film™ that produces wafers in a matter of minutes, instead of days. Unlike many other advanced PV technologies that rely on unproven or toxic new semiconductors, APex™ products are based on crystalline silicon.



The bottom line is lower price *and* peace of mind.

MADE EVEN EASIER.

When you choose a PV supplier, you are choosing not only the products, but also the company behind the products. It's nice to know that your supplier shares the values that brought you into the PV business. AstroPower is uniquely:

Independent; AstroPower is the only major PV manufacturer not controlled by some large multi-national corporation. We have only one business, – your business, the PV business.

Clean; We use silicon wafers recycled from the semiconductor industry to make our single crystal solar cells. This allows us to deliver high quality products while consuming only a small fraction of the energy used by our competitors.

Dedicated; The most focused and dedicated people in the industry work at AstroPower. We work here to make a difference, and we take pride in the company because we all own part of it.

If you would like to join the AstroPower team, please contact us at:



ASTROPOWER
ASTROPOWER

Phone: 302-368-6088 Fax: 302-368-6087
www.astropower.com

ReNew The Earth Institute:

A New Home for the MREA

Tehri Parker & Mick Sagrillo

©1999 Tehri Parker and Mick Sagrillo

MREA's new passive solar, energy-efficient home: the ReNew the Earth Institute.

Last February, the Midwest Renewable Energy Association finally purchased a building and five acres in the rolling farmlands of central Wisconsin. The center, the ReNew the Earth Institute, is being developed into a unique learning environment that will offer hands-on renewable energy workshops, interactive displays, and a comprehensive resource library. It will be powered by the sun and wind.

Midwest Renewable Energy Association

It all started with a two page article in the August/September 1989 issue of *Home Power* magazine (HP12). Richard Perez wrote an open challenge for a group to organize a "People's Energy Fair." As Richard saw it, interested folks could gather and learn about renewables as well as share information and experiences in a relaxed, informal atmosphere.

Inspired by that article, a group of Wisconsin renewable energy (RE) users and dealers formed the Midwest Renewable Energy Association (MREA). The first Midwest Renewable Energy Fair (MREF) was held in August of 1990. That first fair brought over 4,000 people to the sleepy little town of Amherst, Wisconsin. They learned about renewable energy, energy efficiency, and sustainable living. Amherst would never be the same!

Ten years later, the MREA is a non-profit organization with over 1,100 active members across the United States. It's also the Midwest regional chapter of the American Solar Energy Society. Our mission, however, is still the same: to educate people about renewable energy in a friendly environment, and to have fun while doing it.

In 1999, our tenth annual energy fair drew a record crowd of almost 12,000 people from 23 countries and all 50 states. Last year, all seven continents were represented. This year we offered 123 free workshops during the three day event, and 118 different exhibitors and vendors were on hand to display their wares.

The Developing Dream

In the mid 1990s, it became apparent that the MREA was destined for a future that included more than its

annual energy fair. Telephone calls and information requests to the MREA had become so numerous that we needed additional staff, bringing the total number to two full-time employees and several part-timers.

Our educational offerings had grown to include a series of weekend workshops, a quarterly newsletter, and numerous presentations to schools and other interested organizations. We had also built the Sun Chaser, a mobile PV display and power trailer capable of powering rallies and concerts with sunlight. In addition, we built a 600 square foot (55 m²) building on the Portage County Fairgrounds, the site of the fair. It replaced our temporary and well-worn model home.

The MREA also found itself represented on a number of environmental advisory boards and political committees. We were working closely with the Wisconsin Energy Bureau and the Public Service Commission of Wisconsin, and even the Energy Center of Wisconsin, the state's consortium of utilities. All of this was happening from a 480 square foot (45 m²) rented storefront.

From all of this activity, the dream of a permanent home for RE education germinated. The board of directors began the long process of developing a plan to acquire

Treasurer Marguerite Ramlow and Executive Director Tehri Parker discuss finances in the daylight main office.



Tehri Parker beams, "We even have our name on the front door!"

and sustain an RE education center. We wanted to create a facility that would model renewable energy and energy efficient technologies, provide a space for our workshops, have educational resources available year-round, and house our offices.

Over the next few years, we explored dozens of site options and made a number of plans. Finally, a capital fundraising campaign with a goal of US\$250,000 was kicked off at the 1998 MREF. Within a mere five months, the MREA raised over US\$90,000 in cash, equipment, and services. Both figuratively and literally, we were ready to move!

The Facility

Like all good success stories, this one contains an element of fate. At the same time that the MREA was actively searching for a new home, another local non-profit organization was searching for a way out of their facility-related debt. Through a mutually beneficial negotiation process, we were able to purchase a nearly new building at less than half its original cost. In return,



Associate Director Katy Matthai greets visitors in our spacious lobby.

the MREA offered the other non-profit, the Central Wisconsin Wildlife Center (CWWC), a new lease on life by allowing them to maintain rent-free office space in the building for the next ten years.

Last February, the MREA finally closed the deal, and we moved into our new home. We bought a 4,800 square foot (445 m²) passive solar superinsulated building, with many energy efficient features. The building was originally designed with a dual purpose—as a wildlife rehabilitation clinic and educational center for the local community.

Our new home includes a large education room for teaching workshops and holding meetings. There is a spacious lobby for displays, and a separate room for a resource library. Since the building's many passive solar design features include daylighting, the office space, lobby, and education room are bright and sunny.

The original six wildlife rehabilitation rooms are being converted to additional office space. There is an enormous kitchen, and a basement for storage and work space. And we even have a two bedroom apartment, complete with its own kitchen, to house workshop presenters and participants.

We call the facility ReNew the Earth Institute (REI). This reflects our commitment to preserving the environment through the use of renewable energy. We also hope to form partnerships with other environmental non-profit organizations (like the CWWC) to offer a variety of educational programs at the building.

Displays & Exhibits

Over the last few months, the MREA has been considering different exhibits and displays for visitors to look at and interact with. By exploring the displays, visitors will discover various RE concepts and principles. We will be working with professionals who design interactive museum displays to develop our exhibits.

These are just some of the displays, exhibits, and RE system installations we are developing:

- Sun Frost refrigerator, 16 cubic feet, 12/24 volt
- Maytag high efficiency refrigerator, 15 cubic feet
- Solar Pathfinder
- Sun Ovens International solar oven
- Straw bale demonstration wall
- Jacobs 2,400 watt wind generator
- Bergey 1,500 watt wind generator

Board members Christine Hulet and Bob Ramlow show off some displays in the lobby.



- Whisper 900 wind generator
- Air 403 Wind Module
- Energy Cycle (bicycle powered generator)
- Energy efficient wall construction demo
- Insulated wall panels demo
- Air-to-air heat exchanger cutaway
- Low flow toilets
- BP 75 watt PV panels
- American Solar King 4 x 8 foot solar hot water panels
- Harris Hydroelectric Systems generator
- Borealis 16 foot (5 m) diameter yurt



The Board of Directors wrangle with issues in the sun-washed education room.

We are also working on a series of one page fact sheets to accompany our displays. The fact sheets will include basic information on renewable energy and energy efficiency technologies, as well as a list of references for finding more information. These fact sheets will be available at the center, through the mail, and on our Web site. The first three (*Strawbale Construction*, *Solar Domestic Hot Water*, and *Off-Grid PV Systems*) should be completed soon.

Renewable Energy System Installations

The MREA is also busy planning and fundraising for the RE systems that will power the facility and backfeed electricity to the utility grid. "We definitely want our facility to walk the talk," explains MREA's Treasurer Marguerite Ramlow. "This is a chance for our organization to develop a model learning center, and to offer more hands-on installation workshops."

One of the first systems that will be installed at the facility is a 3.6 KW Jacobs wind system on a 100 foot (30 m) freestanding tower. This system will include a Trace SW5548 inverter, with battery storage of eight Trojan L-16s. Monitoring equipment will be installed on the tower to sample wind speed at multiple heights, wind direction, solar insolation, temperature, and wind turbine electrical output. The monitoring equipment will be connected to an interactive computer display in the lobby, and output information will be posted on our Web site. The entire system will be installed as part of a two week hands-on workshop in May of 2000.

The ReNew the Earth Institute is currently heated by a propane-powered central heating system. Our plan is to supplement this with a solar hydronic in-floor heating system. The hydronic heating system will be made up

of twelve used 4 by 8 foot (1.2 x 2.4 m) American Solar King collectors, an 80 gallon (300 l) storage tank, a 4 foot (1.2 m) Quad Rod heat exchanger, and several Hartell DC pumps. The solar hot water panels will also be used to heat the domestic hot water for the building.

The building is already plumbed for the hydronic heating system, with tubing running through a sand bed under the office area, lobby, and education room. There is even a heat dump system built into the floor of the basement.

To heat the building when the sun isn't powering either the passive solar or the solar hydronic heating system, we are considering building a masonry wood heating system. Sometimes referred to as "Russian" stoves, these heaters consume a large batch of firewood in a very hot, fast, clean burn. The mass of stone making up the heater absorbs most of the BTUs produced by the firewood, then slowly radiates the heat to the surrounding area over the course of the day.

We will also be installing a grid-intertied PV system and tracker at the site. The system will consist of sixteen BP 75 watt panels, a Wattsun dual-axis tracker on a 20 foot (6 m) mast, Trace inverter, and battery backup. Monitoring equipment that can be integrated with the wind monitoring equipment and displayed on our Web site is still being researched.

All of the installations will be offered as hands-on workshops through the MREA. Complete information on these workshops will become available as funding for the hardware is secured for the various installations. If you're interested in any installation workshops, keep your eyes on our advertisements in *Home Power*, or visit our Web site for current updates.

Next Steps

In early August, the board of directors completed a planning session for the next three years. We have just hired another full-time staffer, Clay Sterling, to develop our exhibits, oversee the RE installations, expand our educational program, and choreograph site development so that the institute shines as an example of sustainability.

During our planning sessions, one of the major goals we identified is to eliminate the use of fossil fuels as an example of what others can accomplish with their homes and businesses. But all of these plans take money—especially large projects like the wind system, solar hydronic heating system, PV array, and masonry heating system. We are currently about halfway towards reaching our capital campaign goal of US\$250,000. If you are interested in supporting one of our projects, or in becoming an MREA member, please contact us.

We are all quite proud of the MREA's accomplishments over the past decade. The ReNew the Earth Institute represents the culmination of a lot of planning, volunteering, and hard work on the part of many, many people. We are grateful to all who have helped out with their time as well as with their monetary and equipment donations. Renew the Earth Institute belongs to all of us. If you're ever in the neighborhood, please pay us a visit.

Access

Tehri Parker, Executive Director, Midwest Renewable Energy Association, 7558 Deer Rd., Custer, WI 54423
715-592-6595 • Fax: 715-592-6596
mreainfo@wi-net.com • www.the-mrea.org

Mick Sagrillo, MREA President, E3971 Bluebird Rd., Forestville, WI 54213 • Phone/Fax: 920-837-7523
msagrillo@itol.com



- POWER LEVELS FROM 1KW TO 60KW
- OUTPUT VOLTAGES OF 100,120,230
- INPUT VOLTAGES OF 12 TO 108
- 20+ YEARS MTBF
- EXPANDABLE
- MODULAR
- REMOTE CAPABLE
- "HOT" SWAPABLE



COMING SOON
BATTERY CHARGERS

TRUESINE WAVE MX SERIES POWER INVERTERS



2225 E. LOOP 820 N. FT. WORTH, TEXAS 76118-7187
 TEL: 817.385.4483 VOICE: 817.385.4969 FAX: 817.385.1290
 WEBSITE: WWW.EXELTECH.COM E-MAIL: INFO@EXELTECH.COM

China Diesel

full page
four color
on negatives

this is page 49

Worried About a Water Emergency?

The solution is simple -

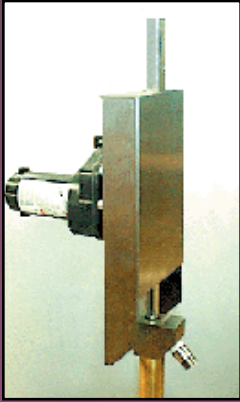

Ideal for remote cabins. Perfect for emergency water.

High precision hand or solar powered water pump.
Fits down inside your existing water well casing.
Does not interfere with your existing submersible.
Can be inter-tied with your existing main water line.
For emergencies or sustained pressurized pumping.
Easy installation in under 2 - 3 hrs. for most wells.
Hand pumps effectively below 350' at up to 100 p.s.i.
12v motor operates with a battery and 30w solar panel.
Far more cost effective than powering a submersible.
Changes from 12v motor to manual in under 5 minutes.
Can operate with any 12v charge source and a battery.

*Of all the things important,
there is nothing MORE important than your water.*

AlternativeEnergySystemsCo

501-839-4017

www.poweriseverything.com

Call us – or visit our comprehensive web site.

Dealer inquiries are welcome.

Some Things Simply Thrive in the Sun.

**Coming
Soon!**



Introducing "HIT POWER 21"

Featuring 17.3% Conversion Efficiency

Sanyo/Solec bring you the Next Generation of Hybrid Solar Cells, featuring the World's Highest Conversion Efficiency for both Residential and Commercial use.

The HIT (Heterojunction with Intrinsic Thin-Layer Solar Cell) is a hybrid composed of a thin single crystal silicon wafer surrounded by layers of ultra-thin amorphous silicon. HIT modules also feature dawn-to-dusk charging and can be placed in high temperature locations without much decrease in output.

Ultra-Thin, Ultra-Efficient... Unrivalled Performance.
It's Advanced Solar Technology you'll want to know more about.

SOLEC
INTERNATIONAL, INC

...bringing the sun down to earth

For more information, call (310) 834-5800.

Knowledge Solar is Power

Data Logging for RE Systems

Tim Nolan

©1999 Tim Nolan

So you finally have your PV system up and running. After many months and thousands of dollars, you are making your own power from the sun. The solar panels are charging the batteries, and the inverter is humming, giving you all the power that your home needs. But how do you know how your system is performing?

How much energy are you generating and how much of that energy are you using each day? That information can help you adjust your power usage to get the maximum benefit from your PV system. It's a case where knowledge is literally power.

Metering

Most PV systems include some sort of metering of volts, amps, or amp-hours. Data from these meters can be recorded periodically to give you some idea of how your system is operating. However, writing these numbers down every day is a tedious and error-prone process. It would be much easier and more efficient to let your home computer do the data logging for you.

You may think you need expensive hardware and software to implement data logging for your PV system. That's not necessarily the case. You can use your Windows PC with software that you probably already have to gather and analyze data from a Cruising Equipment E-Meter, a commonly used PV monitoring device.

Test System

As an electrical engineer, I've always been interested in alternative energy, so I decided to install a small PV system at my house. My system consists of a 53 watt Solarex panel, a 12 volt deep cycle battery with fuse, a 250 watt Statpower inverter, and an E-Meter to monitor the system. This system is obviously too small to provide much energy for my house, but I do use it to run my computer. And I've learned a great deal while setting this system up and using it.

I had previously installed an E-Meter in my 1961 Chris Craft motor boat. I was very impressed with how easy it



Tim Nolan logs his single-panel system's performance digitally using a Windows PC.

was to use, and with how much useful information it provided. The E-Meter monitors the voltage and the current into and out of the batteries. It basically acts as a battery "fuel gauge" by keeping track of the amp-hours that are left in your battery.

My PV panel makes electricity, adding to the amp-hours in the battery, and the inverter that runs my computer uses electricity from the battery, subtracting amp-hours. The E-Meter keeps track of input and output and shows the net amp-hours. It has four LEDs that are labeled from *Empty* to *Full* like a fuel gauge on a car. I purchased the E-Meter with the optional serial data output. This option outputs all the information that the E-Meter collects as a serial data stream that the PC can read.

Cables and Ports

The E-Meter is connected to the serial port on the PC with a serial cable. The serial connector on the E-Meter is a 9 pin D style connector. In most cases the PC serial port will also use the same connector. You'll need a 9 pin to 9 pin null modem serial cable, which you'll be able to find at any computer store. A null modem serial cable just swaps pins 2 and 3 from one end of the cable to the other. This allows the transmit pin of the E-Meter to connect to the receive pin on the PC. If you have an older PC with a 25 pin D style serial connector, you will also have to buy a 25 pin to 9 pin serial adaptor.

Most serial cables have a male connector (you can see the pins) at one end and a female connector at the other end. Both the E-Meter and the PC have male connectors. So you either need to get a cable with two female connectors (which may be hard to find), or buy a little widget called a gender changer. The gender changer has two female connectors, and when you plug it into the male connector on the cable, you end up with a cable with two female ends.

HyperTerminal

Once you get the cables straightened out, it's easy to upload the data into the PC. Every Windows PC comes with a terminal emulator program called HyperTerminal, which will allow you to upload the serial data from the E-Meter and save it to a text file. This program is usually found in the Accessories folder. Double click on the icon for HyperTerminal to start the program. At the prompt, type in "E-Meter" to name the new connection, and click *OK* to continue (Figure 1). See my Web site and the *HP* Web site for screen shots of all the operations described in this article.

Figure 1: Creating a New Connection with HyperTerminal



On the next screen, make sure "Direct to Com 1" is selected on the "Connect using" line. This will select serial port 1 on your computer (Figure 2). When you click on *OK*, you'll see the next screen, which allows you to set the hardware configuration for the PC serial port (Figure 3). To work with the E-Meter, the serial port should be configured as follows: Bits per second: 9600; Data bits: 8; Parity: none; Stop bits: 1; Flow control: none. If you have your E-Meter connected when you click on *OK*, you'll see data appearing on your screen. Congratulations, your computer is now logging data from your solar electric system. Make sure you select *File* and *Save* to save this new HyperTerminal configuration so you can use it again.

Figure 2: Choosing Serial Port 1 with HyperTerminal



Figure 3: Setting the Hardware Configuration

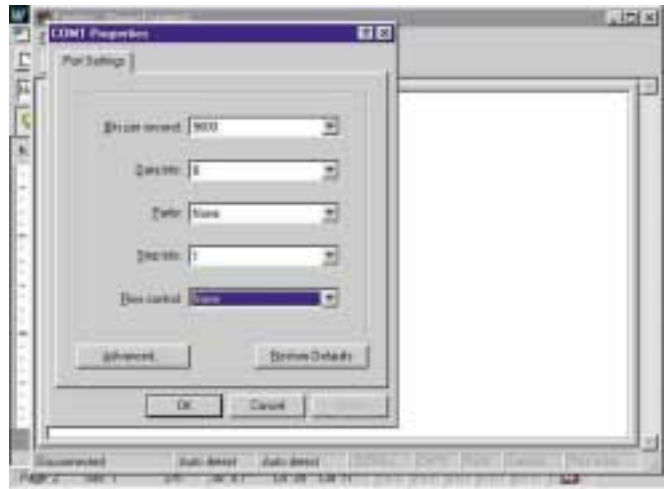

Sorting Out the Numbers

The serial data coming from the E-Meter consists of nine or ten numbers separated by commas (Figure 4). These numbers are the key to understanding what is going on in your system. They look something like this:

08589, -00.14, -006.3, 12.00, -0014.2, -0021.6, -0009.4, 017.2, 5

The first value, 08589, shows the number of seconds since the batteries have been fully charged or since the E-Meter has been reset. The second value, -00.14, is the number of kilowatt-hours of electricity that have been extracted from your batteries. The third value, -006.3, indicates the amperage. In this case, we have negative 6.3 amps, which means that 6.3 amps of electricity is flowing out of your batteries. When your PV array is putting more current into your batteries than you are using, that value will be a positive number.

The next value, 12.00, is the voltage of your batteries. The fifth value, -0014.2, is the number of amp-hours

Figure 4: E-Meter Data Logged by HyperTerminal

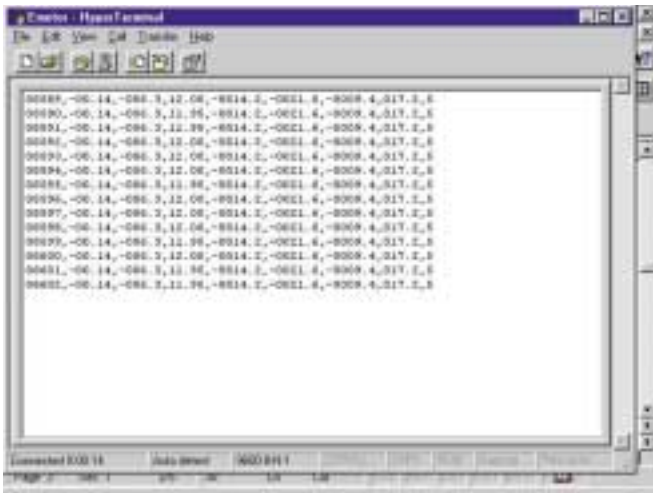

that have been drawn from your batteries. The E-Meter starts with zero amp-hours for a fully charged battery and counts down the amp-hours that are used.

The next two values are used by the manufacturer for “trouble shooting and development,” so we can safely ignore them. The eighth value, 017.2, is an estimate by the E-Meter of the time remaining (in hours) until the battery is discharged. This depends on the size of battery and the current rate of discharge. The last number is an indication of the “fuel” gauge on the face of the E-Meter. In this case, the value of 5 indicates that the gauge is showing “full.”

Save Your Data

Once the data from the E-Meter is flowing into HyperTerminal, you can save it in a file (Figure 5). Select *Transfer* and *Capture Text*. You’ll then see the screen that allows you to select the name of the file to save your data to. You can give the file any name, then click *Start* to begin the capture.

Figure 5: Capturing Text (Data) to a File

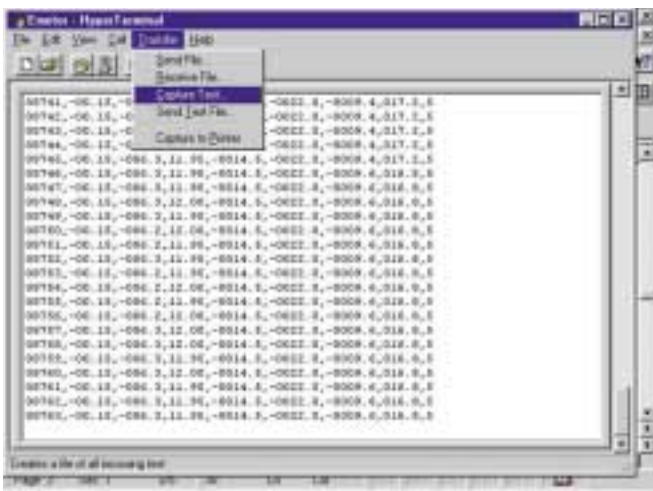

After you have your E-Meter data saved in a file, you can import it into a spreadsheet program to graph or analyze it. I’ll use Excel as an example, since it is a common Windows spreadsheet program. Once you launch Excel, choose the *File* menu, select *Open*, and then select the text file that has your E-Meter data. You’ll see the screen that will allow you to import text data into Excel (Figure 6). Make sure you select “Delimited” as your type of data and hit *Next* to continue.

Figure 6: Importing Data into an Excel Spreadsheet

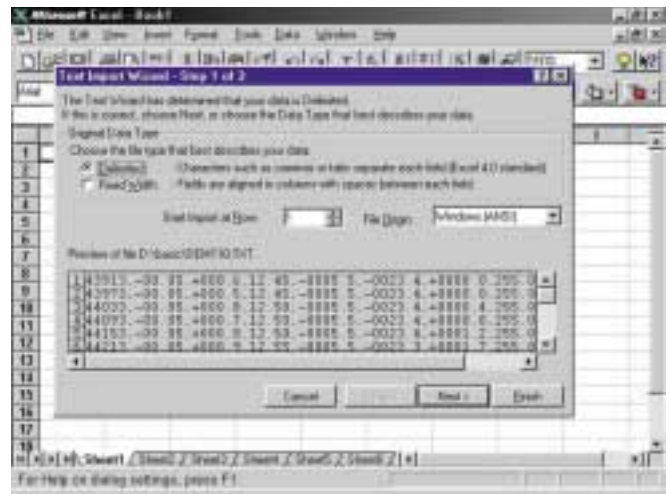

The next screen allows you to select comma delimited data (Figure 7). This just means that each value from the E-Meter is separated from the next value by a comma. Hit *Next* to continue to the next step. The next screen says that Excel will convert your data into numbers and text, so hit *Finish* to end the data importing process (Figure 8). You’ll see a screen that looks like Figure 9—that’s your E-Meter data in the Excel spreadsheet ready for analysis.

Figure 7: Selecting the Delimiter

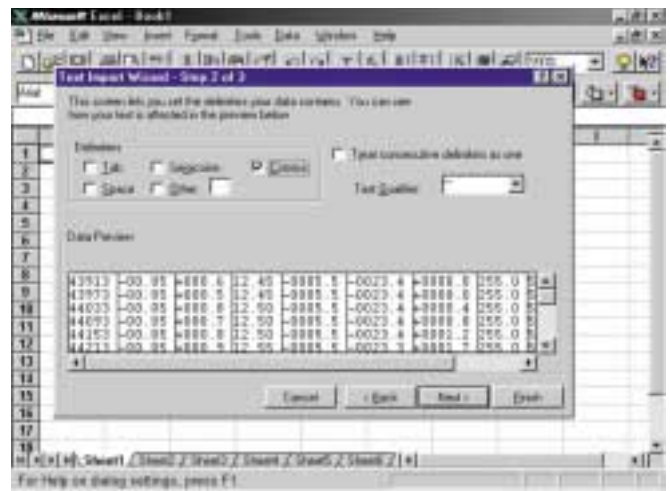

Figure 8: Finishing the Excel Import Process

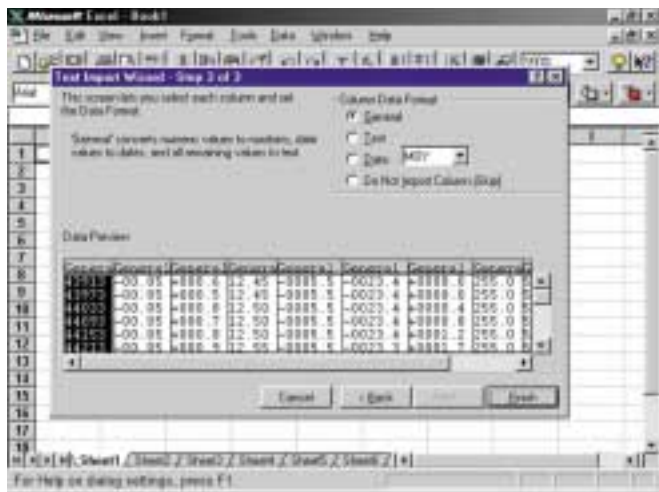
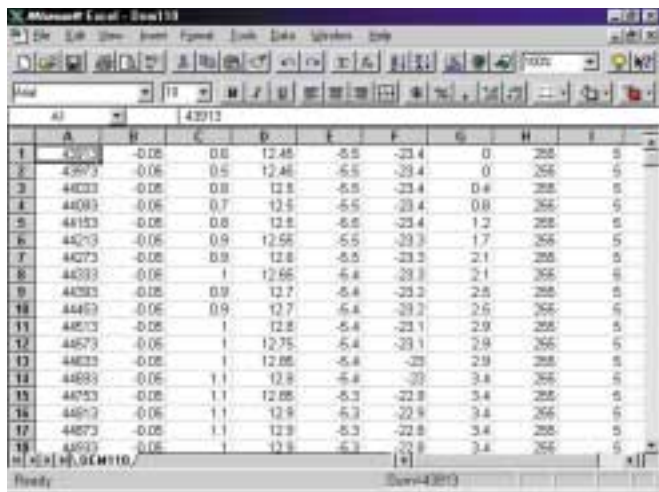

Figure 9: E-Meter Data Imported into Excel



Graph It

One of the things you can do with your data once it's in a spreadsheet is to graph it. It is easier to understand the data when you can see it in a graphical format. First select the column that you would like to graph. If you select column C, you'll graph the amperage data from the E-Meter (Figure 10).

Click on the chart button. You may need to drag it over the column you selected. This will start the five steps of the *Chart Wizard* which helps you make a chart of your data. Step through the *Chart Wizard* by hitting *Next* each time. You'll end up with a chart that looks like Figure 11. You can choose from many different types of charts; make sure you take some time to experiment.

Too Much Data!

One of the problems with using an E-Meter to do data logging on your PV system is that it generates too much data. The meter outputs a line of data every second,

Figure 10: Selecting Column "C" for Graphing

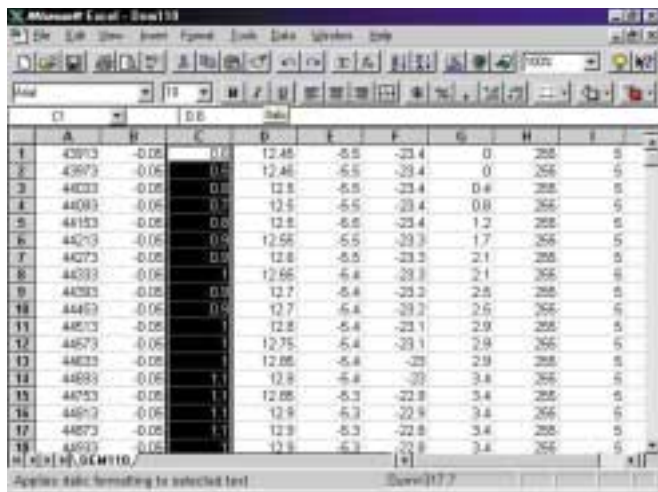
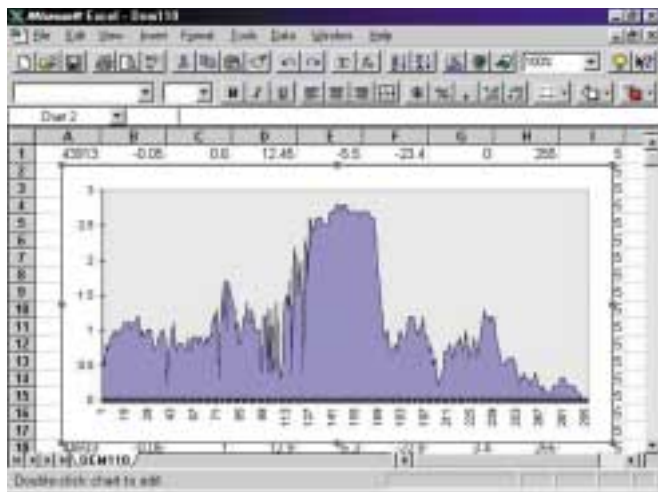

Figure 11: E-Meter Data Graphed in Excel



which can quickly add up. One day's worth of data from my system ended up being a 1.8 megabyte file. This is too much data for most spreadsheets to easily handle. To solve this problem, I wrote a small program in Basic that does data decimation. Decimation is the technical term for getting rid of the data that you don't want.

You can download the program *decimate.bas* from my Web site, or from the *Home Power* Web site. To run this Basic program, you need to have QBASIC on your system. This program runs from an MS-DOS window. I've also included a compiled version, *decimate.exe*, so you don't need to run Basic.

Decimate It

When you run the program, it will ask for the name of your data file and the name of the file to store the decimated data. The program then asks you how many lines to skip between each saved entry. Since the E-Meter outputs a line of data every second, if you type



The author at his workbench.

in 60 you'll copy one line of data to the new file every minute. Once the program is done, you can import your new file of decimated data into the spreadsheet.

If the E-Meter makes 1.8 megabytes of data per day, you'll need a very big hard drive to save more than a few days worth of data. I've written another basic program to read the E-Meter data coming in from the serial port and decimate it before it gets saved to your hard drive. My program also adds the date and time to each line of collected data. This is a big help when you have months of data to analyze.

The program is called *etime.bas* and can also be downloaded from both of the previously mentioned Web sites, along with the compiled version, *etime.exe*. When run, the program will ask for a file name to store the data, how many data entries to skip before saving, and which serial port to use, Com 1 or Com 2. By saving data only once every five or ten minutes, you should be able to collect data for months at a time without overflowing your hard disk.

An Analytical Tool

I hope this article has shown that data logging is a simple but powerful tool to get the most out of a PV

system. As you can see, you don't need expensive or complicated software to get started on analyzing your PV system data. If you own a Windows computer, you probably already have the software you need!

Once you start data logging, you can actually see what your PV system is doing over the course of the day or month, or even over the whole year. Subtle problems with your system such as corroded connectors or shading at certain times of the day become immediately obvious. Keeping a long term history of your system will also help you plan for equipment upgrades or new electrical loads. The equipment for data logging is simple, the software is readily available, and for any PV system, knowledge is power—solar power!

Access

Author: Tim Nolan has a Masters degree in Electrical Engineering and is an Embedded Systems Engineer and Hardware Designer • 2436 Sommers Avenue, Madison, WI 53704 • 608-242-7075
timnolan@timnolan.com • www.timnolan.com

Cruising Equipment Company, 5245 Shilshole Ave. NW, Seattle, WA 98107 • 206-782-8100 • Fax: 206-782-4336
techhelp@cruisingequip.com • www.cruisingequip.com

Excel and HyperTerminal, Microsoft products for the Windows operating system: Microsoft, One Microsoft Way, Redmond, WA 98052-6399 • 800-426-9400 or 425-882-8080 • Fax: 425-936-7329
www.microsoft.com

Solar Village
Institute Inc.

Renewable Energy
Dealer, Installers, Educators
Solar, Wind & Micro Hydro Systems
Serving the Carolinas and Virginia.
Off grid since 1992

Solar Village Institute inc.
Chris and Lyn Carter
PO Box 14, Saxapahaw, North Carolina, 27340
fax/phone (336) 376-9530, voice (336) 376-9292
Email solarvil@netpath.net www.solarvillage.com

**SOME PEOPLE SAY OUR ENGINEERS
MUST BE ROCKET SCIENTISTS...
PERHAPS THEY ARE!**



**Launching the new
2500 watt POWER STATION**

**Sine wave inverter/charger from a name you can count on
for performance, reliability and a price that can't be beat.**

Features:

Sine wave output
Powerful 120 amp 3-stage charger
Line-tie capable
UL and CUL listed

Optional Features:

Generator start
Full meter display
Stackable for more power
Remote communication

low
introductory
price

\$2,165⁰⁰

Suggested list price

SEE YOUR LOCAL TRACE SUPPLIER FOR DETAILS

**TRACE
ENGINEERING**

www.traceengineering.com

FOR OFF GRID, BACK UP POWER, UTILITY INTERACTIVE, PV, WIND, GENERATOR HYBRID

You Can't Always Rely on the Grid

But you can always rely on Rolls batteries.



You have invested in an alternative energy generating system. Make sure your battery is not your weakest link. Insist on North America's best deep-cycle battery... Rolls.

- Dual-container construction eliminates potential leaks, stray current, and decreases maintenance
- Unsurpassed cycling due to the most dense active material in the industry
- Modular construction for easier installation
- Average life expectancy is 15 years - Warranted for 10 years



Rolls

BATTERY ENGINEERING

1-800-681-9914

Surrette Battery Company Ltd., Springhill, NS, Canada, B0M 1X0
www.surrette.com e-mail: jds@surrette.com

BACKWOODS SOLAR ELECTRIC SYSTEMS

For an Earth Restored and a World at Peace

Independent Electric Power Systems for the Remote Home — Solar Electric, Wind, Hydro

We are a family business, living with our products for over 20 years, and offer the knowledge to help you set up your off-grid home energy system. Free Consultation. Questions are personally answered.

Our catalog includes a planning guide to help you understand how to put your energy system together—its applications and sizing. We offer lower than usual prices on **Solarex** and **Siemens** PV modules and **Kohler** generators. Our **Trace** inverters include free battery cables. We carry **Sun Frost**, **Nova Kool**, and **ConServ** refrigerators, specialized appliances and lighting, and a range of meters and controls: **Heliotrope**, **SCI**, **Pulse**, and **TriMetric**.

Our \$3 Catalog/planning guide is FREE to Home Power readers.



Most items in stock for immediate shipment. We accept VISA, MasterCard, American Express, and Discover



Steve & Elizabeth Willey • 1395-HP Rolling Thunder Ridge • Sandpoint, Idaho 83864

Phone: (208) 263-4290 • Fax: (208) 265-4788 • E-mail: info@backwoodssolar.com • Web: www.backwoodssolar.com

Golden Genesis Company is Proud to Become Kyocera Solar, Inc.

We are NOT an Oil Company ...
We are NOT a Utility ...
BUT WE PROVIDE ENERGY.

Kyocera is a global producer of high technology solutions. Our commitment to solar and other renewable sources of electricity began in 1975 with the creation of Japan Solar Energy Corporation. Since then we have grown to become the World's Largest Manufacturer of solar electric modules, producing 29 megawatts last year.

We believe in solar energy. Our corporate headquarters is powered by more than 200 kilowatts of solar modules and features many integrated systems that are both energy saving and innovative.

As the new millennium approaches, we are strengthening our

commitment to preserving the world's resources and broadening the positive impact of solar electricity. To that end, we proudly announce our merger with Golden Genesis Company – a world leading manufacturer and marketer of solar electric systems.

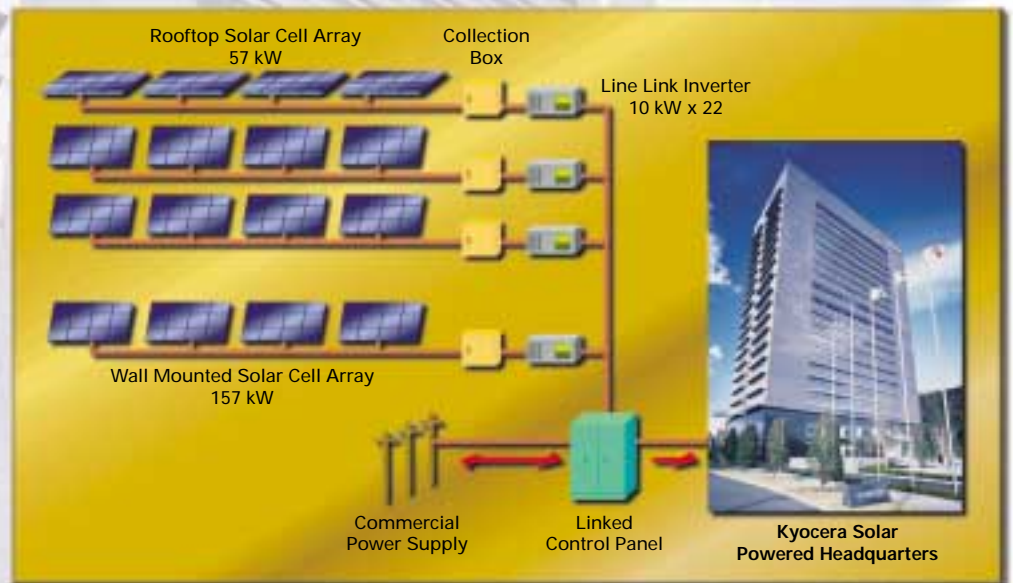

KYOCERA SOLAR, INC.
7812 EAST ACOMA DRIVE
SCOTTSDALE, AZ 85260
480/951-6330
800/544-6466
FAX 480/951-6329
www.kyocerasolar.com

Solar Boats from Finland

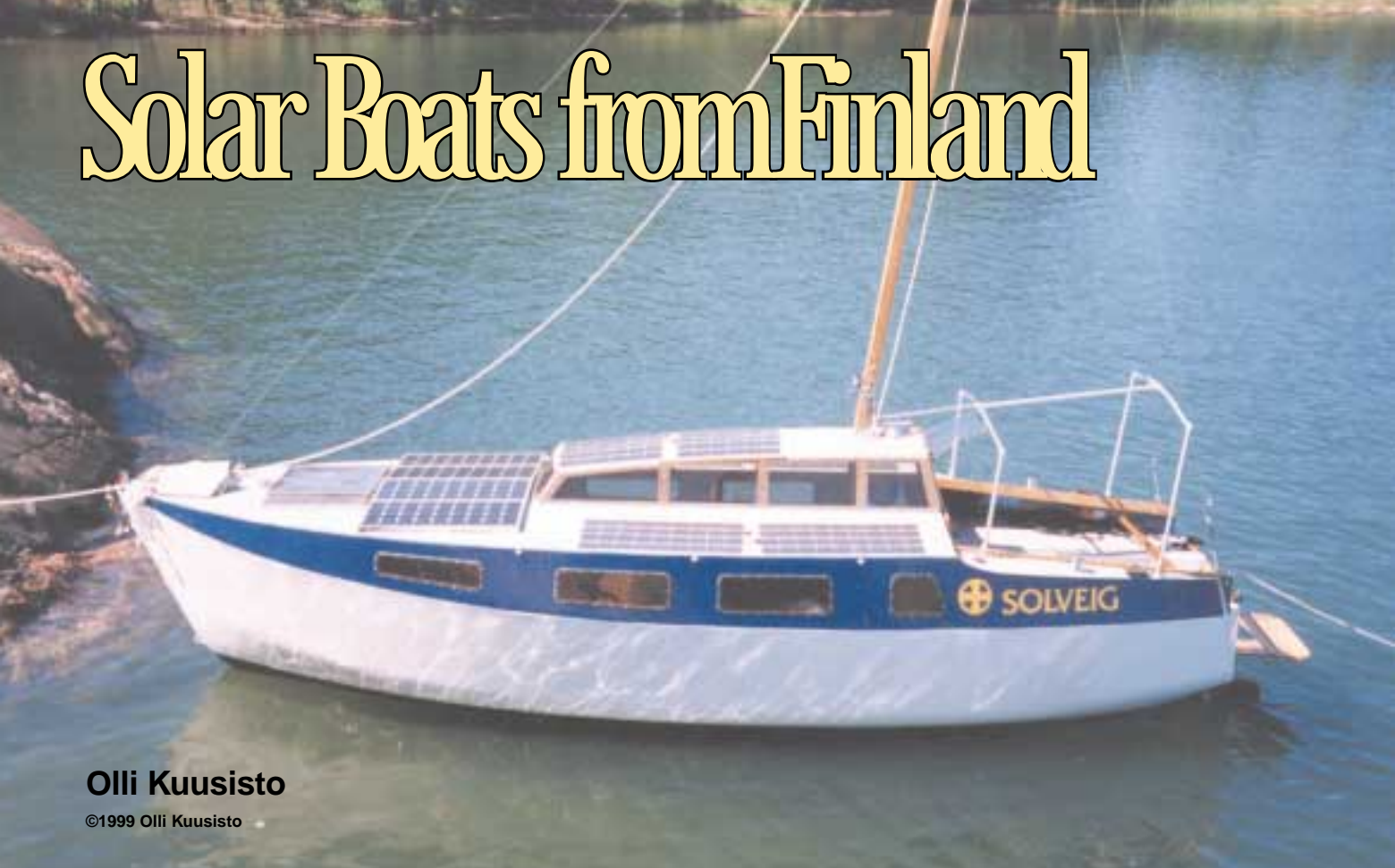

Olli Kuusisto

©1999 Olli Kuusisto

Olli Kuusisto's solar-powered *Solveig* at rest in a cove in Finland. The custom mast prevents shading the 620 watts of PV.

When my good friend Jorma Ponkala and I started experimenting with solar boats some ten years ago, we heard one claim quite often: *Solar boats are unrealistic in Finland. There is too little sun!* That's true in winter, when the sea and lakes are covered by ice, and nobody is boating anyway. But in the summer, the sun almost doesn't set.

The Beginning

Jorma started by building himself a 17 foot (5 m) submarine-shaped boat for one to two people. He put together a 200 watt, 24 volt electric outboard motor and put 200 watts of solar panels on the deck.

My first boat was almost 17 feet too, built of plywood and intended for all kinds of experiments. The motor was a 12 volt, 250 watt unit. It's installed on rubber feet to avoid noise and the shaft comes out through the transom. I also have 200 watts of PV. These boats are very practical in the inner part of our archipelago. They are very shallow draft and light, making it easy to pull up on the shore for the night. This lets us sleep peacefully without having to be afraid of sudden storms.

When we first tested our boats, everything worked, but they were too slow. The speed was only about 2 knots. After a little thinking, we bought a couple of glass-fibre reinforced nylon propellers for model planes. They were 10 inches (25 cm) long and very thin. It was almost unbelievable, but with these props, the speed of the boats almost doubled. Now we always take the original props off all electric outboard motors and change them to model plane props. These props do have one weak point—they gather sea-grass very easily.

Solar vessel *Aton* moored in a Finnish archipelago.





Christina Mether and Matti Kukkonen.

Solar boats are the watercraft of the future, with the following characteristics:

- Energy autonomy; the “fuel” is renewable energy such as solar, wind, and pedal power.
- Economy; solar energy is free. Solar panels, electric motors, and battery technology are decreasing in cost.
- Noise reduction; the solar boat is silent. You can listen to the sounds of nature, talk, or enjoy quiet music while the boat is moving.
- Ecology; an electric boat is a real ZEV (zero emission vehicle).
- Comfort in use; the solar boat has lots of space for its size, because the electric motor is small and there is no need for a smelly fuel tank or oil changes. The boats are very easy to handle.
- Range of use; the solar boat is suitable for different environments—the open sea, lakes, rivers, and canals.

For four summers my family enjoyed gliding around in the archipelago of

southwestern Finland. What a fantastic feeling to move forward without any noise or smell of gasoline! It was possible to listen to the real natural sounds of the surroundings and observe wild birds. After these positive experiences, we started planning family-sized solar boats.

Solar Boat *Solveig*

In the planning of *Solveig*, the basic point was that it had to be as ecological and energy-efficient as possible. For most people, however, ecology is not reason enough. In order to be attractive, *Solveig* had to be cheaper than ordinary boats, and of course she had to suit my personal financial situation as well.

The hull was built of glass-fibre reinforced plywood and ecologically heat-impregnated wood. This non-toxic new impregnation method makes domestic pine resemble mahogany. I have noticed that a plywood boat is dry and comfortable in use compared to a glass-fibre boat. Plywood is a cheap, strong, light, and locally available material too.

Although *Solveig* is an electric boat, it would have been foolish not to take advantage of the wind almost always blowing on the sea, if it could be harnessed without disturbing the solar qualities. The mast was placed as far back as possible on the cabin roof, leaning slightly backwards to avoid shading the PVs on the forward deck. In this way, the area of the sail could be significantly increased.

My original intention was to use the boat on shallow rivers, canals, lakes, and on the open sea. In the part of the southwestern Finnish archipelago where I'm living, there are many beautiful routes. But in many cases, the bridges from one island to another are too low for conventional sailboats. Therefore, the mast had to be collapsible.

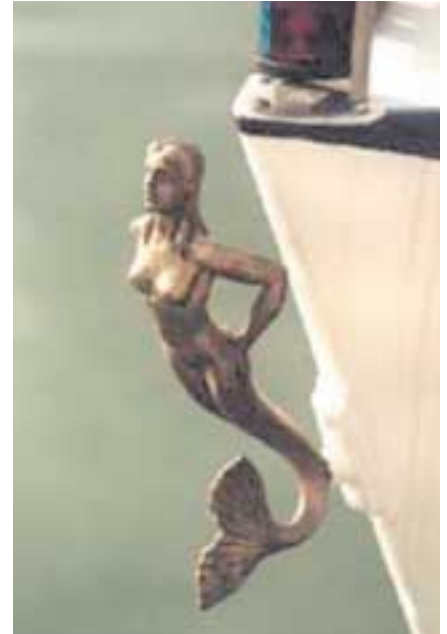

A bronze mermaid adorns the prow and can be used to tow *Solveig*.

Boat builder Matti Kukkonen, who had the responsibility of actually building the boat, constructed an ingenious and simple mechanism that made it possible to instantly lower and raise the mast. The mast was placed on the cabin roof in a steel case (called a foot) about 8 inches (20 cm) high.

When you want to lower the mast, you open the handle on the side of the case and take the rope coming from the stern and mast top. Let the rope glide slowly through your hand and the mast will come down. When you have to raise the mast, you push it up a little bit by hand, pull in the rope and the mast comes up. Close the handle, hook the rope in the stern, and then you can raise the sail.

Because the boat had to be really shallow-going too, a centerboard could have been used. But we chose to build a long, broad keel-box where the six used 125 amp-hour batteries could be placed. In this way, the batteries don't take any room in the boat and also stabilize it when sailing. The electric motor doesn't take much room either. The



Aton's unique look is the outcome of a solar-focused design.

speed regulator was placed in a little hand-sized box with a cable so that the steering could be done any place in the boat.

For me it was very easy to christen this boat. Solveig is a very old Scandinavian name that means "the solar path." The symbol next to the name is a sun-cross from Viking times. But most important—my daughter's name is Solveig, so I had no real choice.

Art is very important to me, and I have many artist friends. A solar boat is clean and comfortable and it's more than natural to have art onboard. The mermaid in bronze in the bow, made by the Latvian sculptor Viktor Suskevic, is not only beautiful, but also useful for towing the boat. Inside is a beautiful little aquarelle and in the aft window on one side (the toilet window) I have a leaded stained glass work. On the other side, passers-by can see three flying angels guarding my boat. This is a hologram by artist Reima Nurmikko.

I still have a pedal-powered generator aboard to produce energy for critical situations. In practice, it has been used to get some physical exercise on longer voyages.

Soon I'm going to try my new little solar heater I built for my wife to take hot showers. All cooking will be done

**Captain Jorma Ponkala at the helm of Aton.
The centerboard hides under the table.**



with electricity. I'm building a little combination electric/wood stove to cook food and warm the boat in late autumn. It can also be used as a sauna-stove. But in the autumn there is very little sun to harness, so I have thought of buying a 500 watt wind generator to offset burning wood for heat. Maybe it's too interesting to plan and build new accessories. I have to be careful not to build my beautiful boat too full of ingenious things.

Solar Boat Aton

My inventor friend Jorma Ponkala's new solar boat design is really interesting. The stern resembles an aircraft and the rest is a little like an aircraft carrier with a big surface area. The smooth surface provides room for a large solar array (if there's enough money, of course). At the aft, the roof can be opened and the end of it moves backwards, letting the open air in for the crew to enjoy. The hull was designed using specialized software.

Jorma is an expert in lightweight building and he chose a layer structure of injected polystyrene foam. Interior and exterior surfaces are of epoxy and glass fibre. The result is a super-light and unsinkable boat.

The boat doesn't have a mast, but there are plans to build a telescopic mast for a wind generator and a wind prop, or to use a kite sail. The wind prop is going to be used in shallow waters, where it's impossible to use a water prop. The centerboard is hidden under the table.

Jorma's boat is slightly bigger than mine and he has built a little electric sauna-bath in the boat. It is in the middle of the boat and is only about two square meters in size. The sauna stove is made of one 30 by 30 cm (12 x 12 in) soapstone plate. It draws 1,200 watts at 24 volts. The chemical toilet is situated under the sauna bench. It takes about a half an hour for the sauna to become warm enough for Jorma's family. The energy consumption is not a problem because it's not used every day and only for an hour at a time.

In the bottom of the boat there is a glass window through which you can admire the underwater world if the water is clean enough. But usually it isn't. The water in the Baltic sea has steadily turned dirtier. The window can be opened and it's possible to take a swim. Because the boat draws only 25 cm (10 in) of water, a low collar around the window is all that is necessary to prevent water from flooding the floor.

Jorma has built a 24 volt electric oven for the boat, and a freeze-box. The Ponkala family loves to pick berries

Solar Boat Aton Specifications

| | |
|------------------------------|-----------------------------|
| Launched | October 1998 |
| Builder & owner | Jorma Ponkala |
| Length | 7.85 m (25.8 ft) |
| Beam | 2.35 m (8.7 ft) |
| Depth | 0.25 m (9.8 in) |
| Cruising speed | 5 knots, maximum 6 knots |
| Berths | 5 |
| Solar panels | 1,200 W |
| Batteries | 6 Moll lead-acid @ 130 AH |
| Electric motor | 1 KW, 24 V |
| Electric motor | 400 W, 24 V for maneuvering |
| Hull | 30 cm injected polystyrene |
| Interior & exterior surfaces | Glass fibre & epoxy |
| Sail | Kite type (planned) |
| Water tanks | 2 @ 150 liters (40 gal) |
| Electric sauna bath | 1,200 W |
| Electric oven | 1,000 W |
| Freezer | 18 W Danfoss compressor |

in the late summer on the different islands, so a freezer is important. An electric kettle is planned, so no fossil fuel will be needed. Jorma even built the 1 KW motor himself, out of scraps he found in different places.

The 1,200 watt solar array produces enough electricity for day trips of about 100 km (60 miles). The six 130 amp-hour batteries contain enough energy for driving the whole night long.

The boat's name, Aton, is derived from the old Egyptian god of the sun. The name is written in golden hieroglyphs on the side of the boat. The symbol of Aton shows blessing arms and surrounds the name.

Range

In good conditions, *Aton* can theoretically be driven at 9 km per hour, drawing 30 amps for thirteen hours. But it's not good to draw the batteries all the way down. This spring I bought new batteries for Solveig. They are closed gel batteries, 90 amp-hours each. The old batteries were 125 amp-hours each, but of the same size. Solveig is now good for only eight hours of driving, at 4 to 5 knots per hour without sun. Perhaps I will buy two more batteries to increase the range.

I organized a trip for ecological vehicles on land and water last year. In four days, Solveig traveled 250 km (155 miles) in very difficult conditions. For two days it was blowing straight against us, and for the next day we had to use energy carefully. To be sure that we could go on in hard weather the the following day, we took electricity from the grid (what a sin!). But the following day was not windy, and after that we didn't have to worry about having enough energy. At the end of the voyage, the batteries had a lot of energy left over.

Solar Boat Solveig Specifications

| | |
|---|--|
| Launched | September 1996 |
| Technical planning & construction | Matti Kukkonen |
| Owner, energy & general planning | Olli Kuusisto |
| Electric planning & technical realization | Claes Mether |
| Electronic devices | Jorma Ponkala |
| Length | 7.00 m (23 ft) |
| Depth | 0.50 m (7.5 ft) |
| Beam | 2.30 m (1.6 ft) |
| Cruising speed | Maximum 6 kn |
| Berths | 4 to 5 |
| Solar panels | 570 W and 50 W self-assembled, leaving room for 200–300 W |
| Batteries | Six @ 90 AH, placed in keel as ballast |
| Electric motor | 1.5 KW, 24 V |
| Mast | Collapsible for instant raising and lowering |
| Material | Fibreglass reinforced plywood & ecologically heat-impregnated wood |
| Water heater | Solar |
| Charger | 220 V / 24 V |
| Sauna/oven | Combined 1,200 W, under construction |

Generally speaking, I have been really satisfied with my boat. I could still buy more panels and batteries and increase the range. But for our purposes, it's enough. I would like to do a long voyage through the European canals or the Russian waterways, but it's a question of money and time. I try to avoid planning new things, but I can't stop myself. I already have a new boat in mind...

Quiet, Fuel-Free Boating

Both of our families are very happy with the boats. After getting used to a solar boat, we are very reluctant to go back to an ordinary noisy boat. We don't use any fossil fuel in any form. The electric motor and the whole system has proved to be very reliable. We enjoy the silence, the comfort, and the autonomy. We don't have to think about where we can find fuel. We can go wherever we want and the fuel is free.

Access

Author: Olli Kuusisto, Sinikuja 6, 21600 Pargas, Finland
+358 2 4110871 • Fax: +358 2 2434066
olli.kuusisto@kaarina.fi

Jorma Ponkala, Ylönkyläntie 32, 25610 Ylönkylä, Finland



RECYCLED POWER



At U.S. Battery, we're committed to doing our part in keeping the environment clean and green for future generations, as well as providing you with premium deep cycle products guaranteed to deliver your power requirements when you need them.



**DON'T SETTLE
FOR ANYTHING LESS
THAN U.S. BATTERY
PRODUCTS!**

“When Hurricane Georges hit Puerto Rico, Two Seas’ mount saved our PV system from disaster.”

- Capt. Denis Martinez, U.S. National Guard

{ 98% shipped in 24 hours }

**Mounts that exceed toughest U.S. hurricane codes,*
backed by our 20-Year warranty.**



Mounts, battery enclosures, and racks available in a wide selection of models to meet any requirement.



Two Seas Metalworks
Willits, CA 95490 USA
800-227-9523
www.2seas.com



*SBC-1606 (110 mph winds). Two Seas mounts rated for 125 mph winds.



Flagstaff, Arizona is a great place—and a great place for a renewable energy fair! On September 18th and 19th, over 5,000 energy-minded folks attended the second annual Southwest Renewable Energy Fair in Flagstaff. We all had a great time—viewing new products, visiting with old friends, and making new ones.

Above: Dave Katz of Applied Power Corporation.

Southwest Renewable Energy Fair 1999

Richard Perez

©1999 Richard Perez

Right: Rick Cullen of RV Power Products.



It Grows!

The Southwest Renewable Energy Fair (SWREF) is a growing event. Attendance was easily double that of last year's first-time fair. This year there were over 50 businesses and organizations with booths, and 27 workshops taught by experts in their fields. Key speakers included Christy Herig of the National Renewable Energy Laboratories, Steve Strong of Solar Design Associates, Inc., and Alan Weisman, author of *Gaviotas: A Village to Reinvent the World*.



Orrin Farnsworth of Intermountain Solar at the BP Solar booth.



Windy Dankoff of Dankoff Solar Products.

came out of this fair with a far better understanding of RE and how they can apply it in their own lives.

These opportunities didn't mean that SWREF was only an educational event. There were dozens of dealers there selling their wares at special show prices. I watched many fairgoers humping PVs, wind generators, inverters, and other RE gear out to their cars. *Home Power's* own CD-ROM guy, Don Kulha, bought an AIR 403 at a great price and he's now installing it at his Northern California homestead. All the dealers I spoke with reported heavy sales and were sporting big smiles.

Jeanine and Robert Vaughan of Solar 4 U.

Fairgoers could attend workshops and have their questions answered by people who have pioneered small-scale renewable energy. Got a pump question? Ask Windy Dankoff, Mr. PumpIt. Need info on small-scale wind? Ask David Calley and Andy Kruse, makers of the Air 403 wind genny. Want to learn about photovoltaics? Ask the folks at the BP/Solarex, Kyocera, and Siemens booths. Got a battery question? Ask Jim Drizos at the Trojan Battery booth. This list could go on for pages. Many questions were asked and answered. Thousands of folks





Monte Haddix of Kyocera Solar.

New Products

One of the best things about any energy fair is checking out the new products. This year's SWREF had several new products on display. Here are just a few that caught my eye. See *Access* for contact information.

Daryl Day and Jim Drizos of Trojan Battery.



Maximum power point tracking (MPPT) for PV arrays is now a happening reality. These electronic wonders squeeze every available milliwatt out of a PV array. Both RV Power Products and FireWind&Rain were displaying new models of their MPPTs. MPPT performance is up. Cost on some models is down to the level of just about any high quality PV charge controller. Since we had already tested RV Power Products' 20 ampere MPPT (*Things that Work!*, HP73), I was ready to test their new 50 ampere model, the Solar Boost™ 50. Rick Cullen, the product's maker, gave us the cook's

tour of this unit. We are planning to install one on our new sixteen module tracker. Stay tuned.

FireWind&Rain was also displaying a prototype of their new pure sine wave inverter. This is a 4 KW inverter suited for both battery and utility intertie service.

Honest Smitty of AAA Solar.





Ezra Auerbach and Sam Vanderhoof of Trace Engineering.

Because it uses 50 kHz voltage conversion, it is tiny compared to other inverters. And best of all, it has a projected retail price of about US\$1,500. Bill Schlanger, president of FW&R, said it will be available sometime next year.

A new startup company, EnQit, was displaying the PowerTK Energy Monitor, their control and data logging hardware and software for computers. This is a very slick and inexpensive (under US\$100) system for both monitoring and data logging RE system performance. It

will also control the system by activating shunt loads and disconnecting power sources. PowerTK Energy Monitor runs on IBMs and Macs under open source Perl/Linux code.

Chuck and Fred Ruscher of Solar-Ovens.com displayed their line of solar ovens. These are well designed, very easy to use, and heavily insulated. In the intense Flagstaff sun, they cooked all varieties of food in amazingly short periods of time.

New Faces

New dealers abounded at this year's SWREF. I have been wondering when a full-time RVer would specialize in systems for RVs. Well, it's happened. Jeanine and Robert Vaughan have formed Solar 4 U, Inc., with the specific goal of bringing today's PV, inverter, and battery products into the RV market. Since Jeanine and Robert are full-time RVers, they live daily with the

products and systems they sell. They are also developing a wind generator mount for RVs. Their motorhome sports an AIR 403 in addition to PVs.

Old Faces

I've never seen an industry that loves to talk shop more than the RE industry. After fair hours, industry folks got together to discuss the state of the art. Kyocera Solar and Southwest Windpower hosted a Saturday night party whose list of attendees read like a Who's Who of the small-scale renewable energy industry. Major topics

One of many solar-powered electric racers at the fair.



The Arizona State University Formula Electric.





The Home Power booth sees some action.

of discussion were net metering, guerrilla solar, corporate mergers, and who is working on the hot products of tomorrow.

Energy fairs such as SWREF are really the only time we get lots of industry folks in the same place at the same time. This year's after-hours party was a huge success and lasted into the early morning hours. RE industry types never really punch out for the day. Perhaps that is why we are all so happy to work in this industry—the folks in it are driven and enthusiastic about their work.

Flagstaff

One of the big advantages of SWREF is that it is held in Flagstaff, Arizona, a wonderful town that is not too big and not too small. Its elevation of over 7,000 feet yields plenty of sunshine without baking everyone out; the weather is mild and pleasant. It's a friendly town full of folks who are glad to host this event. Flagstaff is also full of great places to eat. The Home Power crew gained several pounds while we were there. Karen even located a great coffee shop that was open early enough for us to prepare for the day. Because of its ideal location and dedicated organizers, this fair has the potential to become one of the biggest in the nation. We had a wonderful time, and we'll be back next year.

Access

Author: Richard Perez, Home Power, PO Box 520, Ashland, OR 97520 • 530-475-3179

Fax: 530-475-0836
 richard.perez@homepower.com
 www.homepower.com

Fair organizers: Kim Poirier, Greater Flagstaff Economic Council, 1300 South Milton Road, Flagstaff, AZ 86001 • 800-595-7658 or 520-779-7658
 Fax: 520-556-0940 • info@gfec.org
 www.gfec.org

RV Power Products, 1058 Monterey Vista Way, Encinitas, CA 92024
 800-493-7877
 Phone/Fax: 760-944-8882
 info@rvpowerproducts.com
 www.rvpowerproducts.com

FireWind&Rain, 3920 East Huntington Dr., Flagstaff, AZ 86004
 800-588-9816 or 520-526-1133
 Fax: 520-527-4664
 sales@firewindandrain.com
 www.firewindandrain.com

EnQiT, PO Box 158, St. Johns, AZ 85936
 520-521-7490 • Fax: 520-521-7490 • info@enqit.com
 www.enqit.com

Solar-Ovens.com, PO Box 3223, Flagstaff, AZ 86003
 520-773-0344 • chuck@solar-ovens.com
 www.solar-ovens.com

Solar 4 U, Inc., PO Box 530485, Henderson, NV 89053
 888-765-2748 or 702-914-8031 • Fax: 702-914-8032
 RVSolar4U@aol.com • www.rvsolar4u.com



Photons In, Photons Out
Solar Rechargeable Lamp



- Antique Brass
- Bright White LEDs
- NiMH Batteries
- 90 Day Warranty

See web page
for details:
www.photonlamp.com

Backwards to the Future, Ltd.

PO Box 409,
Fennville, MI 49408

Fax: 616-236-6186
email: sales@photonlamp.com



**More
Power!**



Get All The Power You Paid For!

**Solar panels...You bought them, and they were expensive.
But are you getting the power you paid for? Be certain with
the state-of-the-art Charge Controllers from Fire, Wind and Rain!**

The Power Advantage series of charge controllers features include...

- **Maximum Power Point Tracking:** Continuously adjusts current from solar panels as it transforms voltage, allowing it to seek the precise point where maximum power is available. This produces up to 25% more power than conventional models.
- **3 Charging Modes:** Bulk charge, constant voltage and equalize.
- **Easy To Use:** Set up with built in LCD display or computer (depending on model). Our exclusive Virtual Control Panel lets you monitor your system and collect data on how much energy has been produced and used, and the state of charge of the battery as well as battery life based on present load.

- Available in 24 and 48 volt models with capacity up to 1500 watts. Also available in both step up and step down voltage models. Ideal for retrofits! Any installation using a conventional charge controller can use a Power Advantage!

To be sure your getting all the power you paid for, we invite you to contact us or the Dealer in your area.



FIRE WIND & RAIN
TECHNOLOGIES LLC

3920 East Huntington Drive, Flagstaff, AZ 86004
(800) 588-9816 • (520) 526-1133 • Fax (520) 527-4664
www.firewindandrain.com

Dyno Battery

full page
four color
on negatives

this is page 72



Microsoft Internet Explorer
Address http://www.yourwebpage.com

Attention Dealers!

Let Our Retail Experience Benefit You!
Our Services Include:

- 24 Hour Toll Free Order Line**
800•671•0169
- Complete Website Development**
 - Secure Ordering •Full Product Photos and Specs
 - Password Protection •High Impact Animation
 - Audio and Video Integration
- Free System Design Assistance**
 - By Factory Certified Techs
 - Over 25 Years Combined Experience
 - Friendly Staff
- Marketing Support**
 - Complete Digital Video & Multimedia Productions
 - Advertisement Design Layout •Literature
 - Lead Generation •Factory Training
- Product**
 - 1,000's of Solar Modules & Inverters in Stock
 - BP Solar's Fastest Growing Distributor
 - All Balance of System Components Available
 - Complete Turn Key Power Systems
 - Lowest Industry Price

Intermountain Solar Technologies - 10288 South Jordan Gateway Dr. #D - S. Jordan, UT 84095
Phone # (801) 501-9353 Fax # (801)501-9352 California Regional Office Call (888) 419-1937

Done Internet zone

**We Offer a Mountain of Service-
Call Us at 800•671•0169**

Proud Partners with



BP SOLAR

A Visit to Southwest Windpower

Richard Perez

©1999 Richard Perez

Founders of Southwest Windpower David Calley (left) and Andy Kruse (below) are committed to renewable energy and their company.

Andy holds a coupler, with guy attachments, for their new tower kit.

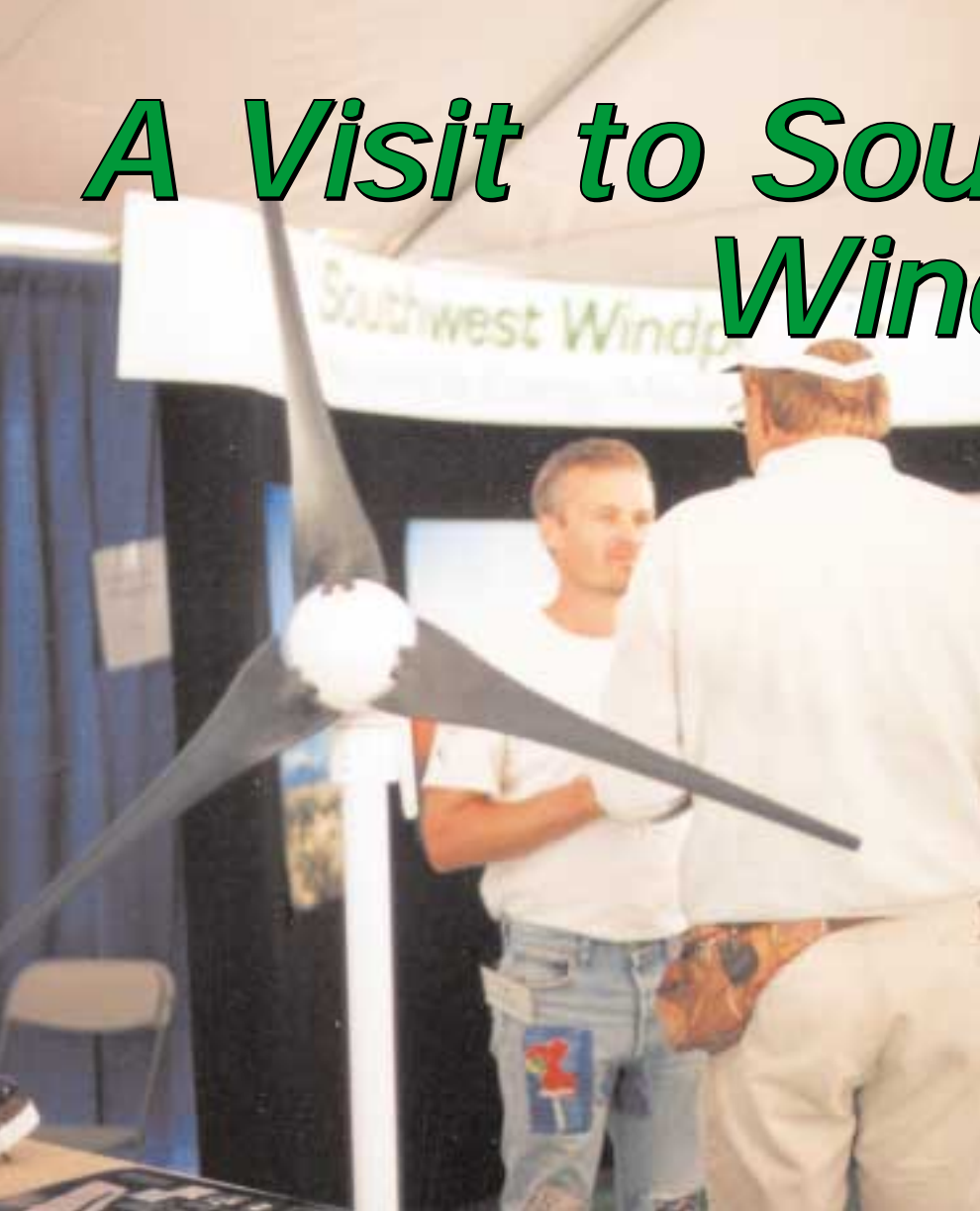

Karen and I first met David Calley and Andy Kruse, the founders of Southwest Windpower, at the 1987 Renewable Energy Technology Symposium and International Exposition (RETSIE) in Anaheim, California. There, amid the utility and industrial giants, these two young fellows were displaying their small wind generator.



The business people attending RETSIE weren't much interested in David and Andy's wind generator. They weren't interested in advertising in the very first issue of *Home Power*, either. The first *HP* issue was due to hit the streets about four months after the 1987 RETSIE conference. RETSIE was a big-time RE business event and almost no one there considered home-sized RE systems to be a reality, or even a remote possibility within the next ten years. They were wrong.

Southwest Windpower

David and Andy formed Southwest Windpower in 1986. David had already begun making and selling wind generators in 1981 while he was still in high school. Their goal with the new company was to make a small wind generator and to sell it to folks wanting to make power for their own homes. This early wind genny was called the Windseeker. It had an output of 300 watts at 28 mph, and a retail price of US\$795.

This machine was a revolution in small wind generators. It was affordable, had a built-in battery charge controller, and contained many technical advances such as variable frequency feedback to control the alternator's field. These early Windseekers made electricity using automotive-style alternators with rotating electromagnetic fields. A refined version of the famed Windseeker is still available. Since 1986, Southwest Windpower has made and sold over 8,500 of these Windseeker turbines.

CNC machining keeps tolerances close and efficiency high on the AIR 403 Wind Module.



AIR bodies are investment cast aluminum to be light and strong.

The AIR Wind Module

In 1989, David began experimenting with permanent magnet (PM) alternators. This experimentation led to the first PM version of the Windseeker, which is still produced today. But this wasn't enough for David and the Southwest Windpower crew. They wanted to design and build a wind turbine that would mimic PVs in simplicity, modularity, reliability, and ease of installation and use. They wanted to tap the tremendous energy available in the wind in the same way that PVs tap the sun's energy. This vision and commitment, coupled with



Every AIR is load tested to rated RPM.
Intake of the wind tunnel.



mechanical engineering, aerodynamics, and listening to customer feedback, eventually led to the first AIR 303 models in early 1995. This slick little generator sold like hotcakes, and gave wind power to more homes than ever before. During 1995–98, Southwest Windpower made and sold over 18,000 AIR 303 wind turbines.

To be sure, there were failures on this new AIR 303 turbine. David and Andy paid attention to each and every warranty return. Why had the machine failed, how could it be made better, how could it be made more efficiently, and how could it make more power, be more reliable, and still cost less? Some three years of R&D led to a new and improved version of the machine.

The AIR 403

This latest version of the AIR incorporates many small improvements over its predecessor. Better thermal handling for the semiconductors, higher powered permanent magnets with rounded leading edges, a refined blade design for more power and less noise, closer tolerances, and more durable materials. No detail was overlooked. Every failure of the AIR 303 was addressed.

The AIR 403 looks much the same as the 303, but the many small differences yield a more powerful and far more reliable wind turbine. The AIR 403 debuted on 3 November 1998. Since then, Southwest Windpower has made and sold over 14,000 of these turbines. The failure rate on these turbines is less than one in a thousand. *Home Power* readers who own the AIR 403s tell me that they are super reliable.

Peeking in at the AIR and tunnel fan behind.

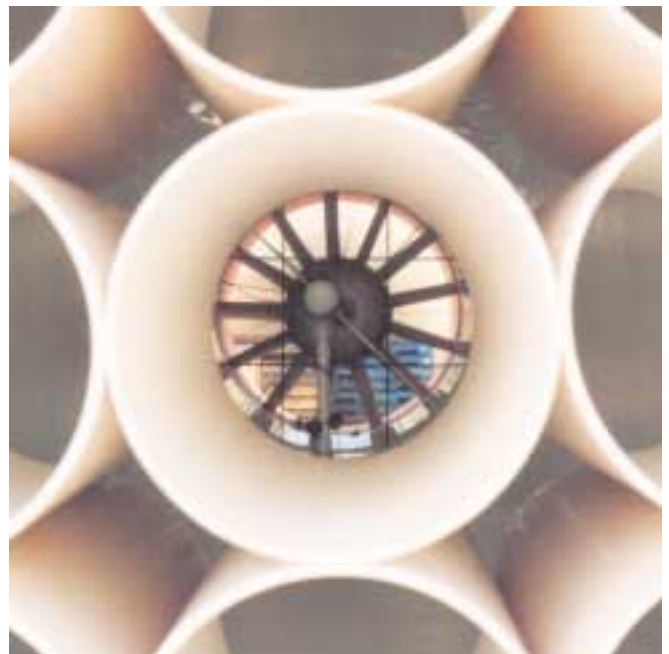

While this is not a big machine—it can't power your whole house—it can make a contribution. If properly sited 30 feet (9 m) above any obstacles within 300 feet (90 m), it can be a good complement to your PVs. According to Southwest's data, if your site has a 9 mph (4 mps) average wind speed at hub height, and you get an average of 4 hours of sun a day, the 403 will give you about as much energy as two 75 watt PV modules. Of course, every site is different, and your mileage may vary. You must put PVs in the sun, and wind turbines up in the wind, if you expect them to make power.

The Scene at Southwest Windpower

David, Andy, and the whole crew at Southwest Windpower aren't just content to produce the fastest

Reporters ogle through the glass at an AIR 403 spinning in the wind tunnel at 55 mph.



selling wind genny on the planet. They want to improve it and make it even more affordable. Their plans call for increasing production by a factor of four in the next two years, and reducing the price. To do this, they have invested heavily in modern production equipment. The new AIRs are made with state-of-the-art casting techniques, computer-controlled milling machines, and even a wind tunnel. As far as I know, Southwest Windpower is the only small wind genny maker that has its own on-site wind tunnel for development and testing of their turbines.

Hi-tech is not the only place Southwest Windpower has been spending their money. They are dedicated to having a happy and healthy crew. David told me he considers all the folks who work with Southwest Windpower to be his family, and I believe him. Over forty employees all receive a family-supporting wage, stock options, profit sharing, and comprehensive health insurance. It was obvious just from a walk through their factory that these folks are happy. Happy workers do better work, and these folks love their jobs!

A Vision for the Future

One of the things we wanted to learn while visiting Southwest Windpower was their new product plans. Some exciting and useful new products are going to be coming our way.

David and Andy realize that one of the major stumbling blocks for small-scale wind is the tower. So they have just come out with an inexpensive tower kit, engineered to support the AIR 403. This kit contains all the necessary hardware, except the locally available tubing

Behind the AIR, looking towards the tunnel intake.





The 480 VAC, three-phase, 65 hp fan at the exhaust end of the wind tunnel uses more power than the rest of the factory.

lengths, to erect a tilt-up tower up to 45 feet (14 m) tall. The kit contains connectors for coupling the 21 foot (6.4 m) aluminium tubing lengths, all the guying hardware, and the gin pole coupler. With this tower kit, users will be able to get this small wind genny high in the air with a minimum of expense and effort. We've needed something like this tower kit for a very long time, and Southwest Windpower is delivering what we need.

The Southwest Windpower crew is looking forward to new generations of the AIR 403. On deck for the future is microprocessor-controlled maximum power point tracking. David expects a radical increase in the AIR's power once there is a computer brain up inside the machine maximizing the flow of power. Also on line for the future are 120 VAC AIR wind modules. These units will be able to run in a utility intertied and batteryless environment. When this machine arrives, it will be the ideal starter machine for guerrilla wind systems. Just put it up and plug it in—blow some clean wind power onto the grid!

David has a firm vision for the future. He imagines many home producers contributing solar, wind, and microhydro energy into a common, local mini-grid, particularly in developing nations. This neighbor-to-neighbor approach to electric power generation reflects Southwest Windpower's attitude toward decentralized renewable energy. As an interesting side note, I examined the printed circuit board which houses their regulator. Printed on this board is "Work for Peace."



Bob and Jeanine Vaughan's RV sports an AIR 403 on a telescoping mast.

This motto is also printed on their promotional t-shirts. These are wonderful folks doing great work!

Access

Author: Richard Perez, Home Power, PO Box 520, Ashland, OR 97520 • 530-475-3179
 Fax: 530-475-0836 • richard.perez@homepower.com
 www.homepower.com

Southwest Windpower, 2131 North First St., Flagstaff, AZ 86004 • 520-779-9463 • Fax: 520-779-1485
 www.windenergy.com • dept56@windenergy.com



The on-line store for
 alternative energy products at discount prices

www.AltEnergyStore.com

E-mail: Sales@AltEnergyStore.com
Sales Tel: (207) 469-7026
 Fax: (877) 242-6718

Northeast distributor for  PHOTOWATT

SOLAR-ONE™ TECHNOLOGY AT WORK: THE HIGH UTILIZATION POSITIVE PLATE

Innovative technology is what separates Solar-One™ from the rest of the pack. Delivering full capacity for more total cycles than conventional batteries, Solar-One batteries are engineered for outstanding performance, from the inside out!

A Take a close look at the Solar-One unique high-utilization positive plate, and you will see that it is our positive grid that provides the foundation for Solar-One Positive Plate Technology. Incorporating the highest quality raw material available in the industry. The Solar-One grid uses our own metallurgical formulation and a computer-controlled grid casting system, another industry exclusive! The result:

B the Solar-One grid contains larger lead crystals, and larger crystals mean fewer points for corrosion to attack the battery.

C To accommodate grid corrosion and growth, many battery manufacturers are forced to use a "floating seal", a battery design which is far more subject to leakage than the Solar-One's burned post-to-cover seal. Having controlled the growth of our positive grid, the Solar-One seal is stronger and less vulnerable to leakage.

D The key to Solar-One's

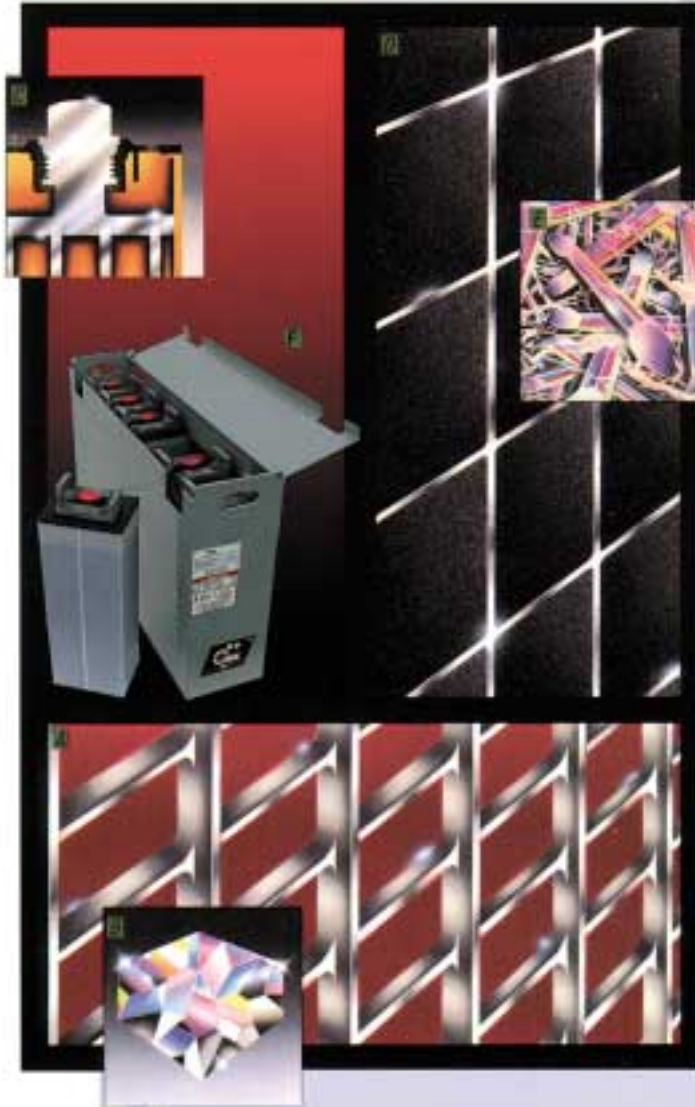

tradition of longer battery life at full capacity is our patented H.U.P. technology (US patent #4,135,829). H.U.P. is a process which optimizes both the active material utilization and the longevity of the positive paste. A colloidal suspension of

tetrafluoroethylene (Teflon®) is added, at precisely measured volume, temperature, and time, to the paste mix and causes the formation of a pervasive network of fibers throughout the active material.

E This process known as fibrillation, locks the active material into place and virtually eliminates flaking and shedding - the chief causes of battery failure.

F Tested at the National Battery Testing facility batteries with H.U.P. have been shown to increase working life by at least 20%, with absolutely no sacrifice of capacity! In fact, H.U.P. batteries deliver full capacity longer, have faster voltage recovery with lower internal resistance, and last longer than conventional batteries. For more power in your Renewable Energy System look for the H.U.P. Solar-One™ label. High Utilization Positive plate technology only from:



The First Name In R-E Batteries

Visit our **NEW Store!**
6791 South Main St.
Suite C
Bonners Ferry, ID 83805

800-718-8816
208-267-6409
fax: 208-267-3973
www.nwes.com
email: batteries@nwes.com



Dealer Inquiries Invited.

- Warranted for 2100 cycles at 80% depth of discharge •
- FREE Shipping in 48 states •
- HUP Technology Patented in 1982 •
- ISO 9000 Certified •

Now you can enjoy the benefits of the Proven Hup Technology in your R-E system with the Hup Solar-One. Best Factory Warranty: 5 years Free Replacement, 5 years Pro-rated.

FREE System Design and Product Catalog for all your alternative energy needs!
Special Pricing on Package Systems / Best Pricing & Customer Service is our Goal

Check our ONLINE CATALOG at [WWW.nwes.com](http://www.nwes.com)

GOH SOLAR'S. NORTHWEST ENERGY STORAGE
800-718-8816
GOH SOLAR OZES.

Dealers Wanted



Reliable People ... Reliable Products ... Reliable Power

SunWize Technologies is looking for experienced solar dealers who want to be a member of our team. Our dealer program includes:

- **Technical support**
- **Training seminars**
- **Cooperative advertising**
- **Lead distribution**
- **Large product inventory for same day shipping**
- **Complete catalog and design guide**

We pride ourselves in supporting our dealers with personal attention. Call our Dealer Sales Manager if you are interested in becoming an authorized SunWize representative at:

1-800-232-7652.

Visit our website at:
www.sunwize.com



SunWize uses Siemens' high-quality solar modules which are certified worldwide and backed by the longest warranty in the PV industry - 25 years!



36 FET's!

More is better and our inverter brings you about twice as many as theirs! Field Effect Transistors provide the muscle to power your appliances. Its no wonder that our Invertrix® 20 (2000 VA) and Invertrix® 25 (2500 VA) bring you higher efficiency and greater reserve motor starting capacity than competing inverters with similar VA ratings! An advanced three stage battery charger and 30 Amp transfer relays complete this advanced inverter/charger!



Available in black or white.

A High-tech LCD Remote Control Panel is included and brings you more power management information than other brands. Up to three Remotes can be installed in various locations for your convenience. Simulated charging and inverter displays are shown below actual size..

Bulk 14.2V 100A

AC 121V 15A 60H

The two displays above alternate while in the Bulk charging cycle. Note that the Hertz display lets you check or set genset RPM's,

Battery Gage 68%

Invtr 12.8V 131A

The two displays above alternate while in inverter mode. 'Battery Gage' lets you know when it's time to recharge.

Our User Programming mode puts you in full control! Now you can set Bulk, Absorb and Float Voltage; and Maximum charging current to match your battery technology and your ambient temperature. You can also set other parameters.. Inverter cutout voltage; Inverter shutdown timer; displayed language selection (*and more*) by simply plugging any telephone into the Remote Control Panel and using the phones dialpad as a keyboard. All data is retained in non volatile EEPROM memory.

- * Available in white or black, 12VDC or 24VDC
- * 30 Month Limited Warranty
- * Optional: Genset Autostart, Battery Temperature sensing

Visit invertrix.com or call for a brochure to get the full story!

Phones: 805-642-7184 Fax: 805-642-7271
800-536-4900 email: info@invertrix.com



Invertrix® Inc.

2259 Portola Rd. Ventura, CA 93003

Dealers.. check our unbelievable start-up offer!



UL-458/CSA Listed.

"Invertrix" is a registered trademark of Invertrix, Inc. Invertrix, Inc. is a subsidiary of Connect Systems, Inc.



Home Power's Business



"The man who on his trade relies
Must either bust or advertise."

Sir Thomas Lipton — 1870

Display Advertising

Advertising Rates per Consecutive Insertion

| | Single Insertion | Three Insertions | Six Insertions | Ad Area sq. in. |
|--------------|---------------------|---------------------|-------------------|--------------------|
| Full Page | \$1,500 | \$1,350 | \$1,275 | 64.1 |
| Half Page | \$840 | \$756 | \$714 | 32.1 |
| Third Page | \$600 | \$540 | \$510 | 21.4 |
| Quarter Page | \$471 | \$424 | \$401 | 16.0 |
| Sixth Page | \$334 | \$300 | \$284 | 10.7 |
| Eighth Page | \$268 | \$241 | \$227 | 8.0 |
| Twelfth Page | \$188 | \$169 | \$159 | 5.3 |

Four process color (CMYK) in any sized advertisement is a flat rate of \$185 per insertion. For inserts, and current subscriber/circulation demographics, please call us.

Home Power is published bi-monthly. The ad deadline for the Feb / Mar 00 issue (HP75) is 14 Dec 1999. Call 530-475-3179 for further details.

International Home Power Subscriptions

Due to the high cost of international mailing, we charge more for *Home Power* international subscriptions.

1 YEAR (6 issues) INTERNATIONAL RATES:

All payments in U.S. currency ONLY!

| | | |
|---------------------|------------|----------------|
| Canada: | Air — \$36 | Surface — \$30 |
| Mexico: | Air — \$38 | Surface — \$30 |
| Western Hemisphere: | Air — \$40 | Surface — \$30 |
| Europe: | Air — \$53 | Surface — \$30 |
| Asia and Africa: | Air — \$64 | Surface — \$30 |
| Pacific Rim: | Air — \$64 | Surface — \$30 |

Surface shipment may take up to three months. All international issues are shipped in mailing envelopes. International subs are best paid for by either VISA, MasterCard, or funds from a U.S. bank.

International orders: Call: 541-512-0201
Fax: 541-512-0343

MicroAds

MicroAd rates are 10¢ per character. Characters include letters, numbers, spaces, and punctuation marks. \$15 minimum per MicroAd insertion. Send a check with your ad. We do not bill MicroAds.

Home Power magazine for Resale

Quantities of *Home Power* magazine are available for resale by distributors, newsstands, bookstores, energy businesses, and others. Please call, email, or write for rates and shipment specifics.

First Class Home Power Subscription

Get 6 issues of *Home Power* magazine via First Class U.S. Domestic Mail for \$36. Many of you have asked for faster delivery, so here it is: First Class *Home Power*. All First Class issues shipped in an envelope. We start your subscription immediately with the current issue.

Back Issues of Home Power magazine

Back issues through #20 are \$3.25 each (\$4.25 each outside USA) while they last. Sorry, no more issues #1–12, 14, 15, 16, 25, 35, 36, 38, 40, 41, 59–61, 63–65, & 67. Back issues of #21–45 are \$4.75 each (\$6 each outside USA). Back issues #46–current are \$5.75 each (\$7.25 outside USA). Back issues are shipped First Class mail. See the ad index for current *Home Power* back issue specials. Issues #1–42, 43–60, & 61–70 on CD-ROM for \$29 each (US\$32 outside USA) Win/Mac/Unix.

Second Class Home Power Subscription

Get 6 issues of *Home Power* via Second Class U.S. Domestic Mail for \$22.50. Second Class can be forwarded for one issue (2 months), so let us know immediately if you move! We start your sub with the next scheduled issue, so please allow ten weeks for your first copy to arrive.

ACCESS ➡ **Home Power, PO Box 520, Ashland, OR 97520 USA**

800-707-6585 or 541-512-0201 Subscriptions and Back Issues

530-475-3179 Advertising and Editorial • www.homepower.com



SOLARFORCE • SOLARAM • SOLAR CENTRIFUGAL

SUNRISE • SLOWPUMP • FLOWLIGHT BOOSTER PUMP • SOLAR CENTRIFUGAL



(FILL IN THE BLANK)

A:



Running an inefficient water pump is like throwing money down the drain. Dankoff pumps reduce your power consumption, saving you money from the day you buy your system. Ask your dealer for details or call us toll free at 888-396-6611. You can also visit us on the Web at www.dankoffsolar.com or e-mail us at pumps@dankoffsolar.com.

The answer's so simple. Get a Dankoff pump.

Chinese Diesel Generator-Set

Water Cooled • Electric Start

- Turn Key Complete
- Industrial Quality
- Free Tool & Overhaul Kit
- 3 Full Hours on One Gallon of Fuel
- **230 / 115 Volt, 60 Hz**, Single Phase
- Guaranteed Parts Availability
- Prompt Delivery / Shipping
- Runs Home, Small Farm, Shops
- One Year Limited Warranty

15, 20, 24, 30, 40 & 50 Kilowatt
Diesel Generators are available upon request

Call Now to Place Your Order, or For More Information

Newinli International, Inc.
13445 Yorba Ave., Chino, CA 91710
Toll Free: 1-877-NEWINLI (1-877-639-4654)
Phone: (909) 364-0667 Fax: (909) 364-0856
Web: www.dieselpowerequipment.com
Email: Newinli@aol.com
Distributors Wanted

7.5KW
\$2,795



10KW
\$3,162



15KW
\$4,885



**New Product
Announcement**

Bergey XL.1

1000 Watt Home Wind Turbine

Features

- ▶ 5-Year Warranty (Industry's Longest)
- ▶ Maintenance Free Design
- ▶ Excellent Low Wind Performance
- ▶ Nearly Silent Operation
- ▶ Three High-Strength **PowerFlex** Fiberglass Blades, SH 3045 Airfoil*
- ▶ Neodymium Super-Magnet Alternator
- ▶ **AutoFurl** "No Worry" Storm Protection
- ▶ Fail-Safe Design, No Dump Load Required for Structural Safety
- ▶ **PowerCenter** Multi-function Controller
- ▶ **OptiCharge** Regulation for Extended Battery Life
- ▶ Easy Installation with BWC Tilt-up Towers

*Patent Pending

24 VDC
Battery Charging



Available
March, 2000

The all new Bergey XL.1 is the most technically advanced small wind turbine ever. It combines excellent low wind performance and the legendary Bergey ruggedness, at costs well below the lightweights. It comes from the world's leading supplier of small wind turbines and is backed by the longest warranty in the business. The XL.1 delivers on value.

Compare features, performance, price, reputation, and warranties. The new Bergey XL.1 is the clear choice for your home energy system.

\$1,495

BERGEY • DIRECT

www.bergey.com

Or, Call Toll Free:
1-888-669-6178

Complete AC "Plug
& Play" Systems
from \$2,995

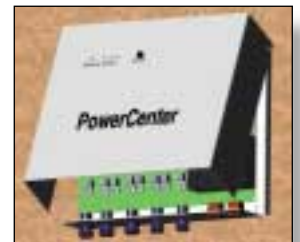

PowerCenter Controller

- 60A Wind Regulator
- 30A Solar Regulator
- 30A Optional Dump Load
- 24 VDC DC Bus
- Battery Status LEDs

Typical Performance: 5.2 kWh DC per day

4 Times More Energy Than the Air 403¹

1.5 Times More Energy Than the Whisper 900²

1—Air is a registered trademark of Southwest Windpower, Inc.
2—Whisper is a registered trademark of World Power Technologies, Inc.

11.2 mph (5 m/s) Average Wind Speed at Hub Height, Rayleigh Distribution.
Based on manufacturer's published power curves.



SIMPLICITY • RELIABILITY • PERFORMANCE

2001 Priestley Ave.
Norman, OK 73069
T: 405-364-4212
F: 405-364-2078
SALES@BERGEY.COM
WWW.BERGEY.COM

New MPPT Controller!

SOLAR BOOST™-50

Global Power Systems

31739 Riverside Dr., Suite L, Lake Elsinore CA 92530
Phone: 909-245-8040 • Fax: 909-245-9611

Web Site Address: www.globalpowersystems.net

Stop throwing your Money and PV Power Away with other controllers that can't deliver full charge current potential. New patent pending Maximum Power Point Tracking (MPPT) technology will extract more power from your PV array. This easily installed device will increase your available charge current up to 30%.

Solar Boost 50 is a 12/24 V photovoltaic (PV) charge controller capable of delivering 50 amps of output current. MPPT technology allows Solar Boost 50 to extract more power from the PV array, resulting in a charge current increase up to 30% or more.

Solar Boost 50 offers an advanced automatic three-stage charge control system to ensure that all battery types are properly charged to full capacity. Electronic current limit feature prevents output current from exceeding 50 amps. Output current limit eliminates worry about overload when PV output is unexpectedly high.

An optional user-friendly digital display shows battery voltage, solar current, boosted charge current, charge mode, and state of charge. It can be provided in the con-troller, as a remote panel, installed up to 300 feet away, or both.



Solar Boost 50 – US\$299.00 (W/O Meter)



Solar Boost 2000
SB2000 – US\$229.00

- ◆ Increased Charge Current = Fewer PV Panels
- ◆ Available Temperature Compensation
- ◆ Available Digital System Monitoring
- ◆ Full 36 Month Limited Warranty
- ◆ Pulse Width Modulation Control
- ◆ Three-Stage Battery Charging & Equilibize

Fall Specials

SW4020 \$2279

4000 Watt Trace Inverter

BP275 \$375

75 Watt Module

20 Year Warranty

SU75 \$315

75 Watt Module

20 Year Warranty

Limited Availability!

The Southern Star in Solar

SERVING THE SOUTHERN UNITED STATES & CARRIBEAN



Tom & Shirley Lane...ECS Owners

SOLAR CONTRACTING SINCE 1977

4,000 REFERENCES AVAILABLE

FULL SERVICE DESIGN & INSTALLATION

SITE SURVEYS / LOAD ANALYSIS / ON-SITE TECHNICAL SUPERVISION

Energy Conservation Services



Tropical Solar Experts

(352) 377-8866



Siemens Solar
PowerPro™

6120 SW 13th Street • Gainesville, Florida 32608 • USA • www.ecs-solar.com

TOP SECRET

GUERRILLA SOLAR:
the unauthorized placement
of renewable energy
on a utility grid.

PROFILE: 0007

DATE: November 1999

LOCATION: Somewhere in the USA

INSTALLER NAME: Classified

OWNER NAME: Classified

INTERTIED UTILITY: Classified

SYSTEM SIZE: 2,400 watts of PV

PERCENT OF ANNUAL LOAD: 70% (estimated)

TIME IN SERVICE: 6 months



As you can see from the picture, twenty-four beautiful Siemens SR100 panels now adorn the roof of my semi-rural home overlooking a small city in the valley below. A Trace 5548 inverter, twenty-four Trojan L-16s topped with Hydrocaps, a Trace C40 charge controller, and a Cruising E-Meter round out one fine system. If the grid goes down the C40 will regulate the battery voltage.

The sun shines incessantly here all summer long. It is a thing of beauty to watch the utility meter slow early in the morning, come to a standstill, and then begin to spin rapidly backwards. And to think we're helping out with the peak summer air conditioning load, too!

That's why I'm a solar guerrilla--it makes too much sense not to be. With today's ultra-safe and sophisticated inverters, it's a no-brainer, win-win situation for both homeowner and utility.

So why does the bureaucracy fight grid-interties? Not because of safety. Not because of lack of mutual advantage. But because of POWER (pun intended). 100% dependence ultimately yields 100% control or power. But now that we can generate our own electricity freely from the sun, we can take that control back into our own hands.

Now when those occasional power outages come due to storms or equipment failure (let alone whatever Y2K holds in store for us), my family will just yawn and enjoy our independence, giving the power company nary a thought.

The process of retrofitting an almost all-electric home has also been a joy. It began last fall with swapping out all those wasteful, heat-generating incandescent bulbs and fixtures, buying an efficient refrigerator and washer, and converting other appliances to natural gas. Next on my list is a solar hot water unit, as soon as the funds are available.

My interest in solar goes back two decades, and flipping the switch this summer was a dream come true. With degrees from two of the nation's premier engineering schools (in Cambridge and Pittsburgh), I love the science and the exquisite engineering that turns photons from the sun into moving electrons that power my home here on earth--cleanly and wholesomely.

This is all part of what God intended when he said, "Have dominion over the earth"--exercising wise, careful, renewable stewardship over the wonderful resources he has so graciously given us. Sola Deo gloria!



REMOTE?

Dealerships
Available

- UL Compliant
- DIY Assembly
- No Wiring
- Complete
- Portable



GenSun, Inc. 10760 Kendall Road, Lucerne Valley, CA 92356 - (760) 248-2689 - solar@gensun.com

LEADERSHIP IN ALTERNATIVE ENERGY

GENSUN

INTEGRATED SOLAR ELECTRIC SYSTEMS

Vanner

four color on negatives

7.125 wide
4.5 high



SIEMENS

SUN
FROST



No Power? No Problem!

Solar • Microhydro • Wind Power • Water Pumping • Remote Communications

We do it all and we do it right!

There is more to a working renewable energy system than a cheap deal on a pile of hardware. While other companies may seem to be cheaper, none are better at building the right, and most cost-effective, RE system for you.

Electron Connection offers: load analysis, site survey, system design, sales, installation, user training, and tech support long after the warranties expire. We live on renewable energy, have over 17 years of experience, and have established over 300 systems. We specialize in NEC® compliant, safe systems that will make your Electrical Inspector smile!

Complete service including installation: We have done systems from Ketchikan, Alaska to Baja California. We have a network of qualified, competent Electron Connection associates across the country. If you need installation or design assistance we will refer you to one in your area. We do it all and do it right the first time!

Equipment via mail order: We offer reasonable deals and technical reality checks. Why settle for a packaged system when you can have yours custom designed by the experts?

Dealers / Installers: Why talk to a “technician” when you can talk to an electrician? We spend half our time in the field installing the equipment we sell you. We KNOW how the systems work and offer technical support, system design assistance, prompt shipment, fair pricing, and NO BULL. Local Referrals. Electrical competence is required. Write today for your dealer application.

Electron Connection

PO Box 203,
Hornbrook, CA 96044 USA
Voice • Fax: 530-475-3401
E-mail:
econnect@snowcrest.net
Web Page:
www.electronconnection.com
CA Electrical Lic #613554



- **Photovoltaics** — Siemens - BP - Solarex
- **High-Quality Batteries** — Trojan - GNB
- **Power Inverters** — Trace - Exeltech
- **Instrumentation** — Cruising - Fluke - Wavetek
- **Charge Controls** — Heliotrope - Trace
- **Trackers & PV Mounts** — WattSun - Zomeworks - Direct Power
- **Microhydro Electric Powerplants** — ES&D - Harris Hydro - Lil Otto Hydroworks!
- **Wind Generators** — World Power Tech - Southwest Windpower
- **Pumps** — Dankoff Solar - Solarjack - SHURflo
- **Water Heaters** — Myson - Aquastar
- **Efficient Lighting** — Phillips - Osram - S&H
- **Safety Gear** — APT - Heinemann - Cutler & Hammer - Square D Products
- **Radiotelephones**



1-800-945-7587

It's 11:45 PM on December 31, 1999. You're hosting the party of the millennium. Armageddon Y2K-style may be just around the corner. But at the very least, you can breathe easily, realizing that your 1999 New Year's Eve party disco ball is not only Y2K compliant—it's Y2K immune!



The mirrored disco ball itself was found in a thrift store in Sacramento, California. We are aware of sightings of similar mirrored disco balls in Patpong (a red light district in Bangkok, Thailand) and in Marin County, California. But it should be easy to make your own if you're handy with a glass cutter and glue gun, and can acquire an appropriately sized spherical object.

If you're lucky enough to find a 12 volt gear reduction motor (C&H Sales has a wide assortment), you can use it to spin the disco ball. The disco ball featured in this article has a 5 volt motor from an old tape deck, with several metal disks, nuts, bolts, and pieces

of surgical tubing to make a reduction gear. The 5 volt DC motor is powered by the circuit shown in the schematic on page 89.

Mount the car headlight so that it shines generously on the disco ball. Use the battery from your car (charged using the PV panel during the daytime in late 1999). It

Both simple to build and completely solar powered, the do-it-yourself homebrew Y2K disco ball (Y2KdB) will allow your New Year's Eve Party to last well into the new millennium.

How to Build the Y2KdB

The basic components are shown in the photo on this page.

- Disco ball with reflective mirrors
- A small DC motor with gear reduction (1–3 watts)
- Capacitor, 100 nF, 25 V
- Capacitor, 1000 μ F, 16 V
- LM7805 voltage regulator IC in a TO-220 case
- LED & 500 Ω resistor (optional)
- Surplus sealed-beam car headlight
- 12 volt lead-acid car battery
- Solar panel (I used a 10 watt panel, but any size will do)
- Boombox modified to run on 12 volts DC
- Disco music

Your Y2K party preparations should include: a power source (a 10 watt PV panel is shown here), energy storage (a car battery will work fine), a light source (rip a headlight out of your car), the Y2K disco ball, a boombox, and your favorite disco music. We suggest "Saturday Night Fever" for that true disco feel, but we understand that all Y2K homebrew hackers aren't purists like us.





Drive assembly for Y2KdB. The small circuit board holds the circuit shown in the schematic diagram below. Notice the generous heatsink on the LM7805 chip. The components are fixed onto a scrap piece of plywood, using hose clamps, hemp twine, and old clothesline.

Y2KdB Drive Assembly Schematic

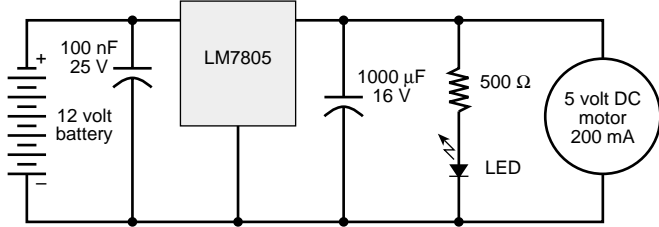

The voltage reduction circuit that drives the Y2KdB's 5 volt motor. This circuit uses the robust LM7805 voltage regulator chip in a TO-220 case. Though this circuit uses an embedded chip, the LM7805 doesn't have the foggiest idea what year it is, and frankly couldn't care less. An optional red light emitting diode (LED) on the output of the voltage regulator indicates that the LM7805 chip is functioning, and provides a year 2000 high-tech feel.

The Y2KdB ready for action. Using string or baling wire, the Y2KdB can be mounted on an existing ceiling light socket or lightbulb. Turn off the circuit breaker first!

will power the Y2KdB motor assembly, car headlight, and boom box. So what if it isn't deep cycle—it will last you until the world ends. Boomboxes that accept eight D-size batteries can be easily adapted to run on an external 12 volt power source such as your car battery. Simply attach wires with alligator clips to the spring electrical contacts in the battery compartment of your boom box. Be careful about polarity!

Don't let your Y2K preparations overlook the most important night of the millennium! Why should your New Year's Eve Party be spoiled by the collapse of the grid (and western civilization)?!?

Party like it's 1999!

Access:

Chris Greacen • cgreacen@socrates.berkeley.edu

Jack Ihle, 1911 Parker St., Berkeley, CA 94704
510-642-6886 • Fax: 510-642-1085
jackihle@socrates.berkeley.edu

C&H Sales Company, 2176 E. Colorado Blvd.,
Pasadena, CA 91107 • 800-325-9465 or 626-796-2628
Fax: 626-796-4875 • candhsales@earthlink.net
www.candhsales.com



! NEW PRODUCT UPGRADE !

48 VOLT VERSION OF
GENNYDEECE

- * NOW 65 AMPS AT 48 VOLT, DC
- * BULK, EQUALIZE, FLOAT ANY SIZE BATTERY UP TO 1500 AMP-HRS @ 48 VOLTS
- * HEAVY DUTY CONSTRUCTION
- * COMMERCIAL RATED OVERHEAD VALVE HONDA ENGINE, W/ LOW OIL SHUT-DOWN
- * PROPANE AND ELECTRIC START AVAILABLE

"Use half the gas and double the reliability of your back-up"

For information on our complete line of 12, 24, or 48 volt DC generators, contact:

Feather River Solar Electric
5575 Genesee Rd.
Taylorsville, CA 95983

530-284-7849
www.psln.com/frenergy

Powered by
HONDA
ENGINES
Authorized O.E.M.



SAME Introductory Price:
\$2,595.00



**LOOKING FOR
1000+ AH?**

Now Shipping!
4-KS-21PS
1104AH (20 hour rate)
15 3/4 (L) X 9 3/4 (W) X 24 3/4 (H)
230 lbs (wet), 186 lbs (dry)

**INTRODUCING...
THE NEW 4-KS-21PS**

- New Generation Dual-Container Modular Design
- 3300 Cycles to 50%DOD.
- Fewer or No Parallel Strings
- Fewer Cells
- Less Maintenance
- Elimination of Stray Current
- Greater Charging Efficiency
- Available Wet or Dry Charged
- 10 Year Warranty



Surrette Battery Company, Ltd.

1-800-681-9914
sales@rollsbattery.com

Rolls
Battery Engineering



**Specializing in
COMPLETE
systems design**

*Solar Electric, Heating,
Water, & Appliances
Including complete CAD
design services*

We can supply everything you need to be off-grid...
inverters to modules to batteries, including your kitchen stove.

All the best brands...

TRACE • KYOCERA

APT • BUDERUS

THERMOMAX

WATTSUN

SOLARJACK • IBE

PEERLESS-PREMIER



Authorized
GOLDEN GENESIS
Dealer

P.O. Box 340, 262 Badger Road
Ennis, MT 59729

Ph 406-682-5646 • Fx 406-682-5644

*Free Catalog to Home
Power Readers in USA*



**Not enough sunshine in your life?
Slash the cost of your power system with**

SUN FROST

P.O. Box 1101, Arcata, CA 95518-1101

Phone: 707-822-9095 • Fax: 707-822-6213 • www.sunfrost.com

Shopping Doesn't Save Money

The Pay-off Comes when You Place the Order!

"click on"

www.BargainSolar.com

*When You Know what You Want...
No Price is Too Small to Pay!!!*

Experience the Simple Elegance of Canyon Turbines



We do turnkey systems for homes or resorts & grid-intertie for net metering in the Rocky Mountain Region.



- Consulting
- Design
- Site Review
- Installation
- Service

Solar Plexus, 130 W. Front St., Missoula, MT (406) 721-1130



The Book on Solar Cookers

Back by Popular Demand

A second edition, fully updated and revised.

Includes:

- A history as well as a who's who in the solar-cooking movement
- Guidelines for designing your own cooker
- Plans for building the **SunStar** cooker with salvaged and inexpensive materials
- Tips and tricks for cooking with the sun

With 200 Photographs & Diagrams

\$15

Outside USA add
\$5 for air shipping

Call Home Power Publishing
800-707-6585

Outside USA 541-512-0201



Y2K COOKING!

While your computer's on ice and the utility is down you can NOW cook with the...

GLOBAL SUN OVEN

The Ultimate Cooking Appliance!

- Cooks any kind of food with the power of the sun—**NO Fuel Needed!**
- Reaches temperatures of 360 to 400 degrees Fahrenheit!
- Totally safe—No danger of fire!
- Used daily in 126 countries around the world!
- Ruggedly built for years of trouble-free use!
- As portable as a small suitcase!



\$219

includes FREE UPS delivery within the continental U.S!

To Order Call: 1-800-338-1781

Sunlight Energy Corporation
4411 W. Echo Lane, Glendale, AZ 85302

Ask us about our complete solar electric Y2K back-up systems featuring the NEW DEEP CYCLE dry cell lead acid batteries.

With 25 years of experience, J. Bornay offers you a complete line of windturbines, from 60 W to 12 Kw.

Juan y David Bornay, S.R.C.
P.O. BOX 116 • E-03420 CASTALLA (ALICANTE) SPAIN
TEL. +34 965 560 025 • FAX +34 965 560 752
WEBSITE: www.bornay.com
e-mail: bornay@bornay.com

Deals of the Millennium

Your last chance to get good stuff for cheap before... well, um, er, before the offer expires. Yeah, that's it.

Deal A

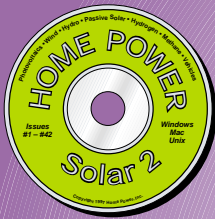

Any Home Power CD-ROM
Value: \$29



New Electric Vehicles
Value: \$25



Any T-Shirt (HP or GS)
Value: up to \$18

or



Heaven's Flame
Value: \$15

= \$49

Save up to \$23

Deal II

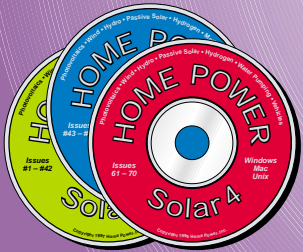

All 3 Home Power CD-ROMs
Value: \$87



New Electric Vehicles
Value: \$25



Any T-Shirt (HP or GS)
Value: up to \$18

or



Heaven's Flame
Value: \$15

= \$99

Save up to \$31

Call Now!

As long as it's between 8:00 am and 4:00 pm Pacific Standard Time.

800-707-6585

Outside the USA, call 1-541-512-0201



We Accept Plastic

The Fine Print: Both deals include United States Postal Service ground shipping inside the USA. For international or overnight shipping information, call our order line. Offer good through January 2000, but if you want this stuff before Christmas, you'd better get on it.

LESSONS FROM A WIND TINKERER

AN
INTERVIEW
WITH
SCORAIG
WIND
ELECTRIC'S
HUGH
PIGGOTT

Interview by
Ian Woofenden

©1999 Ian Woofenden and Hugh Piggott



Hugh Piggott with a lightweight 500 watt machine.

Hugh Piggott moved to Scotland's windswept Scoraig Peninsula in 1974. After a few years, he and his family became tired of kerosene lighting and no "conveniences." That's when he started experimenting with wind energy. Twenty-five years later, he maintains a string of "windmills" for his Scoraig neighbours, and designs, builds, and installs wind generators for companies and individuals all over the world.

While Hugh installs and maintains many different commercially made machines, at heart he is a tinkerer and a homebrewer. His books explore wind machine design starting with the basics. In this interview, we will explore beginning concepts of wind machine design from the perspective of the home builder, and then apply this knowledge to help you evaluate commercial machines on the market today.

Part I: Wind Generator Design

So where do you start when you design a wind generator?

That's a good question. In theory, you should start by considering your energy needs, and measuring the wind speed. Then you can choose a suitable size for the machine and move on to the detailed design. In practice, because the generator is the hardest part to find or build, the design tends to start with the generator (usually it's an alternator) and proceeds from there, so as to make the best use of it.

Either way, it is critical to match the generator to the rotor blades for speed and power. It is also essential to have some sort of control system. You can learn to do these things the hard way, or you can use a bit of simple theory.

OK, so how do you match the alternator to the rotor?

The alternator (or whatever sort of generator you use) will have what is known as a "power/speed characteristic." This is simply a graph showing how much power it produces at each speed, from zero up to full power and beyond. At low speeds it will produce no power at all, because it cannot produce enough voltage to charge a battery. Above the cut-in rpm (revolutions per minute), it will produce power, but there will be a slope to the curve and it will not produce rated power until a higher speed is reached.



One of Hugh's home-built wind generators in Scoraig Scotland. The alternator is built from the brake drum of a truck.

The rotor will also have an optimum power/speed characteristic, which relates to its size and shape. To get the best out of the rotor, you ought to load the rotor so it will follow this curve reasonably closely. This will occur if the characteristic of the rotor matches the characteristic of the alternator. But there is a twist. You need to match the rotor to the alternator input (shaft power) rather than its output power/speed. This can be harder to find out about than the alternator output characteristic, although the two are related.

You will probably want to mount the rotor blades directly onto the generator, for simplicity and efficiency, unless you plan to include a gearbox in the machine (which brings a host of other problems). The optimum rotational speed for the blades is quite low. For more power, you will need a larger rotor diameter, which reduces the rpm still further. It takes a while for the blade tips to travel 'round that big circle. You either need to have the tips travel very fast, which is noisy and causes erosion, or you will need a

Hugh balancing a set of wooden blades for an African machine.



Wind



**A battery charging wind turbine built by Hugh on Scoraig.
The dynamo (generator) came from a bus.**

very low speed generator. A big slow rotor will crank out plenty of power for years and years.

AC or DC? Three phase or single phase? High voltage or low voltage?

Basically a generator is just a magnet rotor moving past a stationary coil, or vice versa. This results in an alternating voltage in the coil which you can use to produce power. Older wind generators used DC (direct current) generators, which turned the AC to DC using a switching device called a commutator. Modern generators produce AC. If you want DC for charging a battery, you can simply use a solid state rectifier to change AC to DC.

Your alternator will produce AC but you will need DC for the battery. If you have no battery, stick with AC because it is easier to switch. And you will certainly need to switch it in many complex ways to maintain the correct load on the rotor.

Three-phase alternators are quieter and more efficient. They produce a smoother DC output (after the rectifier) too. I recommend three phase over single phase any day.

High voltage is better in terms of its ability to cover distances. It can be preferable where the wind machine is a long distance from the point of use. In some cases, a 48 volt battery is better than a 12 volt battery, but in other cases it makes sense to use 240 volts AC and then convert it to 12 volts DC for the battery. But remember that high voltage is dangerous, and a runaway wind generator will produce a much higher voltage than in normal operation.

Well, let's talk about the rotor now. What makes a good rotor?

A good rotor is designed to run at a certain speed, relative to the wind speed. This relationship is known as "tip speed ratio." A slow, high-torque rotor for a pumping windmill will have many wide blades. But generators work better at high speed, which leads us to fewer, narrower blades. This type of rotor produces less torque, but it runs well at high rpm. If we try for very high speed, the rotor efficiency drops, and the blades become noisy and suffer from wind erosion. If there are fewer than three blades, they also shake the whole machine.

Purely in terms of the rotor's own efficiency, a middling speed is best. The best rotor would have many slender blades. But for the best overall machine, we go for a three bladed rotor because it is simpler to build. It turns the generator faster, but not so fast as to cause problems.

What's better, horizontal or vertical axis machines?

Most machines are horizontal axis—the shaft is horizontal and the blades spin in a vertical plane. Enthusiasts often try to build vertical axis machines (which rotate like a roundabout on a vertical shaft), because they perceive certain advantages, such as "no need for a tail," and "no need for a tower," etc.

I have never been attracted by this idea, but I have watched others try and fail. Vertical axis machines are usually less efficient than horizontal. The blades are subject to a punishing (and usually short) life, during which the wind hits them from left and right in rapid succession, until they crack and fail. Vertical axis machines are not easy to support on a tower, and they are not easy to control. They are not usually self starting, but they cannot be relied on *not* to self start. What seemed a good idea turns out to be a whole can of worms.

Governing is vital to keep a wind generator up and running. What different approaches are there and how do you view them?

There are basically two main approaches: blade pitch control and sidfacing. Blade pitch is the better way to do it if you can do it right, but it is very difficult. The

power output is very sensitive to the exact pitch angle of the blades, so a small change can give a quick response. Normally the control system pitches the blade into stall if the speed exceeds a certain limit, thus maintaining a constant speed. But altering the blade pitch requires that the blades be mounted on some sort of bearings or hinge, and the mechanism usually also includes a spring. It is surprisingly difficult to make pitch control systems immune to wear and breakage.

Sidefacing systems are cheaper, simpler, and cruder. There are various ways to make the rotor face away from the wind, either sideways or upwards, to reduce the area exposed to the wind. The simplest way is to mount the rotor a little to one side of centre, so it is always trying to yaw away from the wind. Then the key is to design the tail correctly.

Yawing or tilting the rotor away from the wind is slower than pitch control, so it is not possible to maintain a smooth output. In fact, many wind turbines stop producing power altogether in high winds. But it is simpler and more reliable than pitch control. And since

**Hugh connecting the coils of a low-speed stator winding.
Note the large diameter for low speed.**



Hugh checks out a 4 KW Windflower.

the batteries are usually quite well charged by the time the wind blows really hard, it is more important to survive the night than to push more heat into the dump loads.

What other components and functions are there and how do they fit into the design package?

There are plenty of details which I have not covered. You will need to plan how to fuse the system for safety, choose the right size of cable, regulate the battery voltage, erect and lower the tower safely and easily, and live alongside neighbours who prefer the sound of their lawnmower to the sound of your wind turbine...

These are just some of the issues to think about. On the whole, you should try to keep things simple. "If in doubt, do without" is a good rule, because each additional "clever" feature will be one more thing that will tend to go wrong.

Part Two: Evaluating Commercial Machines

Now that you've given us a brief overview of what goes into the design of a wind generator, help us apply this knowledge to evaluating off-the-shelf



KW” or whatever—and use this as a basis for comparing machines. Actually it is much more appropriate to compare rotor diameters, because the rotor is the part that catches the wind. If the rotor is small, then it can only produce its rated power in a very high wind. In reality, a wind turbine produces most of its useful energy in lower windspeeds where the maximum power is irrelevant, but the rotor diameter is crucial.

The best information for comparing machines is the energy production in KWH per year, tabulated against mean windspeed. With this data, you can predict what to expect at any given site. But energy tables or graphs are rarely given, and even then they are not independently checked, and are usually optimistic.

Hugh Piggott's Scottish homestead as seen from the top of a sixty foot tower. The tower behind the house is a forty footer.

machines. What's the first thing you look at when you see a new wind generator?

I look for weight and substance, because that gives me confidence. If you want useful power, you will need a large machine. And if it is large, then it will be subject to some large forces in high winds, so I look for strength and stability. I look for large bearings and strong fastenings. I like a heavy machine.

What do you look for in the rotor/blade assembly and its relationship to the generator?

I look for a large rotor, because that's the engine. If the rotor is small, but the maker says it is very powerful, then I am wary. Maybe it is very powerful, but only in very high winds. I would want to have useful power every day, not just in very windy conditions.

Equally important, I look for a realistic operating shaft speed. The working speed (rpm) is not always available in the advertising literature, but if it is, you can calculate the tip speed of the blades. If the diameter times the rpm exceeds 1,500 (diameter in m), or 5,000 (diameter in feet), then the tip speed is going to reach 80 metres per second (180 mph). This is too fast for my taste. For example, a 1.5 metre (5 foot) diameter machine should not exceed 1,000 rpm if you ask me. Overspeed will not spell disaster, but it will probably mean more wear and tear than a low speed machine would see.

What about wind turbine ratings? How can we compare the output of one machine to another?

Most people look at the rated power—"500 watts" or "3



This complex wind machine built by an enthusiast in Ireland has pitch control, a gearbox, and a load-controlled synchronous alternator.

I agree with Paul Gipe who said, "Nothing tells you more about a wind turbine's potential than rotor diameter."

What is usually the weakest link in the machines you have seen?

Typically it is a combination of excessive speed with insufficient strength. For example, sometimes the blades are mounted on a steel plate, with nothing to stiffen it. In wild conditions, the blades will flex this plate until it cracks with metal fatigue.

A lightweight tail with undersized fastenings may last a while, but an overspeeding rotor may shake it off, and this could be dangerous for people below. Even the method of attaching the windmill to the tovertop is quite critical, and inadequate fixings have led to many problems.

There are relatively few manufacturers of wind generators in the world today, and none of them seem to be getting rich. Why is it so hard to build a good wind generator and develop it into a profitable product?

There are many factors conspiring here. Electricity is cheap, so it is hard to compete with grid power and diesel power. Manufacturers face a competitive environment. It is not enough to be green and fun—it has to be cheap as well.

The wind itself is a very challenging medium to work with. A successful wind turbine needs to be sensitive to the slightest breeze or it will let you down during gentle winds, but it has to be able to survive the fury of storms. There is also the demanding schedule. These things keep on turning day after day for years, and put in many more miles each year than your car does in its lifetime.

I have many gripes with the manufacturers, but I also have enormous respect for what they do. Making small wind turbines that work is far from easy.

Many people try to build their own wind generators and fail to make a useable machine. Why is this? Is it worth trying?

It's worth trying, but you have to be realistic. Many fail because they have underestimated the task. Finding a low speed alternator is a big obstacle to begin with. Correctly matching it with a suitable rotor is also quite a skill, which most people do not possess. Building it strong enough to be safe and durable is not easy. Creating a fail-safe system to prevent overspeed is a challenge too.

I would say it is worth trying, provided you go in with your eyes open to the problems. My advice is to be very conservative, and learn about what works from others.



Another home-built gearbox machine. This one also has pitch control and a synchronous alternator.

That's what I did. Do not be tempted by clever ideas. They have mostly been tried before and have failed.

What excites you about wind power? Are you still dreaming of a machine that you haven't designed and built?

I dream about wind machines all the time. It's a disease. The only cure is to build them. We live in a world rich in free, natural energy, which is out there for the taking. There are few thrills to beat a well-engineered wind turbine working in a good breeze, for me anyway. I'll go on designing them and building them and fixing them and talking about them for as long as I am allowed.

Access

Hugh Piggott, Scoraig Wind Electric, Scoraig, Dundonnell, Ross Shire, IV23 2RE, UK
+44 1854 633 286 • Fax: +44 1854 633 233
hugh.piggott@enterprise.net
<http://homepages.enterprise.net/hugh0piggott/>

Hugh's most recent book, *Windpower Workshop*, plans for a brake-drum wind turbine, and videos about Hugh and his work are available from www.picoturbine.com in the U.S. For workshops in Ontario, based on Hugh's ideas, see www.windmill.on.ca.

Interviewer: Ian Woofenden, PO Box 1001, Anacortes, WA 98221 • Fax: 360-293-7034
ian.woofenden@homepower.com







Specializing in Solar Electric Power Systems Worldwide!

| Photovoltaic (PV) Panels | | Retail | Sale Price |
|---|--|--------|------------|
|  | BP 275 (75 Watt) | \$499 | \$369 |
| | BP 585 (85 Watt laser-grooved) | \$650 | \$415 |
| | 10+ panels BP 75W @ \$360 each, 20+ panels BP 75W @ \$350 each | | |
| | Free Shipping on 10 panels 48 States / Free Shipping 20 panels 50 States | | |

| | | |
|----------------------------------|-------|-------|
| Astro 120 Watt Solar Panels | \$349 | \$560 |
| Free Shipping on 20+ Astro 120 W | | |

 Call for Two Seas Universal PV Mounting Structures

| Southwest Windpower Wind Generators | | Retail | Sale Price |
|---|----------------------------------|--------|------------|
|  | AIR 403, 12 & 24V Land (400 W) | \$595 | \$529 |
| | AIR 403, 12 & 24V Marine (400 W) | \$845 | \$749 |

| Regulators/Controllers | | Retail | Sale Price |
|---|-----------------------------------|--------|------------|
|  | Trace C 40 (40 amp 12-24-48 VDC) | \$195 | \$149 |
| | Trace TC-60 (60 amp 12-24-48 VDC) | \$329 | \$229 |

| Inverters | | Retail | Sale Price |
|---|--------------------------|--------|------------|
|  | Trace SW 2512 (sine) | \$2580 | \$1945 |
| | Trace SW 4024 (sine) | \$3405 | \$2335 |
| | Trace DR 1512 (mod sine) | \$990 | \$725 |

Prices do not include shipping or sales tax if applicable.

Phone: 702-914-8031, FAX 702-914-8032

TOLL FREE USA 1(888) SOLAR4U (765-2748)

Email: rvsolar4u@aol.com • Web Site: www.rvsolar4u.com

We accept Visa, MasterCard, American Express, Discover, and Electronic Checks

RENEWABLE ENERGY with the EXPERTS

An Instructional Video Series
on the Basics of Residential Renewable Energy

Residential Solar Electricity **\$39.95 each**
with Johnny Weiss, 48 min.

Johnny Weiss is one of the founders and teachers at Solar Energy International, in Carbondale, CO.

Residential Wind Power
with Mick Sagrillo, 63 min.
Mick Sagrillo has installed and repaired over 1,000 wind turbines.

Residential Microhydro Power
with Don Harris, 44 min. Don Harris has designed and manufactured over 1,000 microhydro power plants.

Batteries with Richard Perez, Editor in Chief and founder of *Home Power* magazine.

Solar Water Pumping with Windy Dankoff, 59 min. Windy Dankoff has been designing and installing solar-powered water pumping systems for 15 years.

Add \$5.00 shipping for international orders

Home Power, Inc., PO Box 275, Ashland, OR 97520
toll free in USA: 800-707-6585 • 541-512-0201

Fax: 541-512-0343

Web: www.homepower.com



Reviewed in HP56



Renewable Energy & Sustainable Living Workshops

Join Us for these Hands-On Installation Workshops

- Grid Tied Wind Systems, Custer, WI May 15-26
- Solar Domestic Hot Water, Custer, WI Call for dates
- Solar Space Heating, Custer, WI Call for dates
- PV for Electricians & Tradespersons, Madison, WI June 10-14

Green
Building
Technology



Photovoltaics, Wind, Hydro

Watch this space
for more upcoming workshops
throughout the year!



Solar
Hot Water

Call or write for more information and course descriptions.

Midwest Renewable Energy Association, 7558 Deer Rd., Custer, WI 54423
phone (715) 592-6595 • fax (715) 592-6596 • mreainfo@wi-net.com • www.the-mrea.org

Solar Energy International

Call for a
Complete Catalog
of Workshops
in 2000

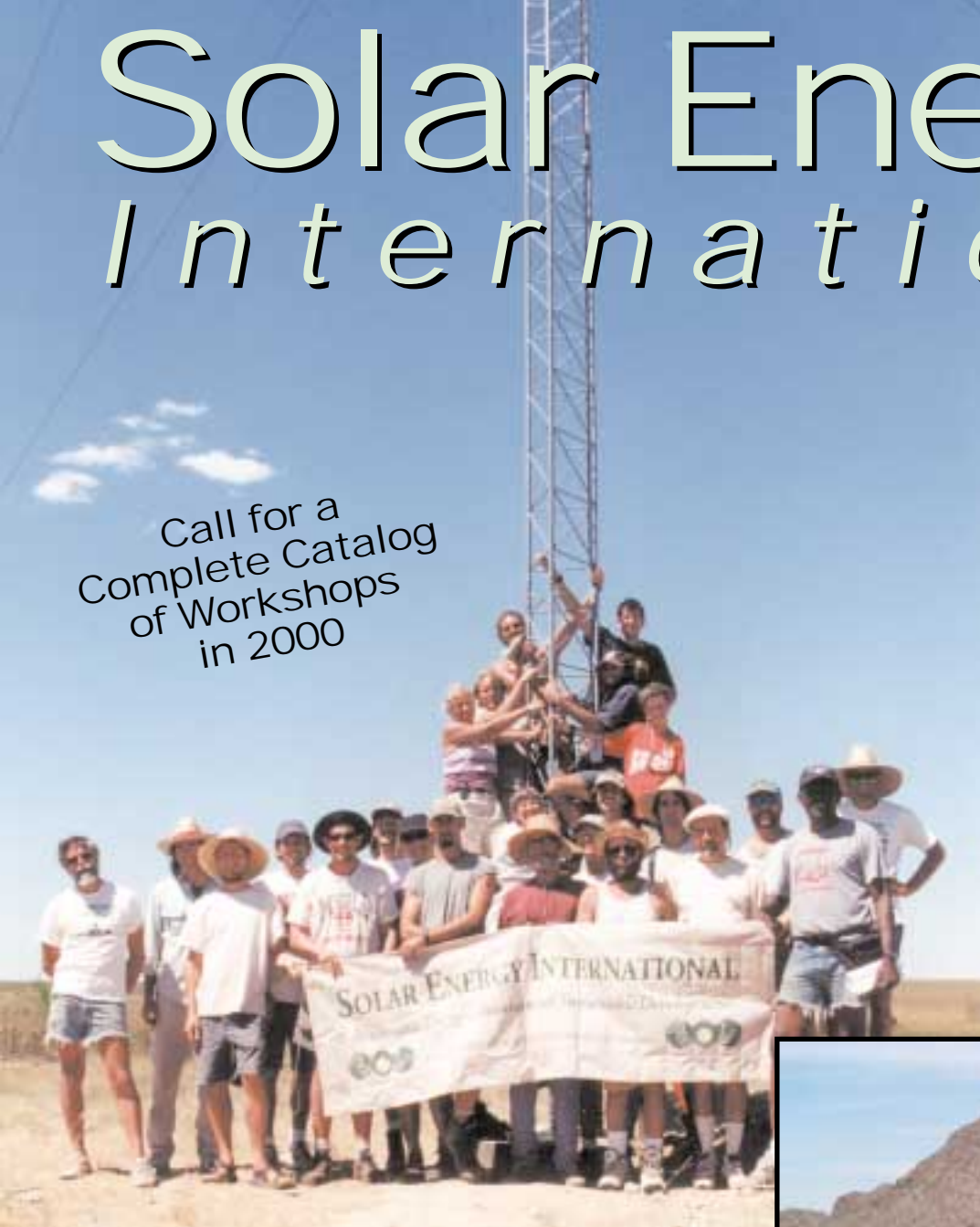

Photovoltaics
Wind Power
Microhydro Power
Solar Home Design
Natural House Building
Straw Bale Construction
Solar Cooking
RE for the Developing World
Successful Solar Businesses



♀ *Upcoming Workshops*
Women's PV Retreat, Tucson Feb. 21–26
PV Design & Install, Phoenix Feb. 28–Mar. 4
PV Design & Install, Austin Mar. 20–25

For more information on SEI,
see the following articles in *Home Power*:

| | | |
|-------------------------------------|--------|-------|
| Jane Goes Solar | HP 49, | pg 6 |
| PV Lighting in the Colorado Rockies | HP 50, | pg 24 |
| A Phoenix is Raised in Colorado | HP 58, | pg 6 |
| Solar Baking Under the Sonoran Sun | HP 59, | pg 50 |
| Take Your Bedroom Off the Grid | HP 60, | pg 16 |
| Mile High Wind Genny | HP 71, | pg 24 |
| Rethinking the Good Life | HP 73, | pg 38 |

Hands-On Education • Sustainable Development

voice: (970) 963-8855 • fax: (970) 963-8866

e-mail: sei@solarenergy.org • web: www.solarenergy.org

P.O. Box 715, Carbondale, Colorado, USA 81623

Renewable Energy on CD-ROM

**Windows,
Mac, or
Unix**

Contains the original magazine layouts
(text & graphics)

**In Adobe Acrobat PDF® format: Color • Fully Indexed
Searchable • Exportable • Printable**

Acrobat Readers included

Solar4

HP61 - HP70
(Oct. '97 - May, '99)

over 1200 pages of Home Power

*Plus: audio RE lectures,
RE system analysis software,
& RE business database*

Solar3

HP43 - HP60
(Oct. '94 - Sept. '97)

over 2000 pages of Home Power

Solar2

HP1 - HP42
(Nov. '87 - Sept. '94)

over 3900 pages of Home Power

Home Power
PO Box 520

Ashland, OR 97520

Phone: 541-512-0201

Web: www.homepower.com

\$29^{ea}

Postage Paid

(International orders add \$3)

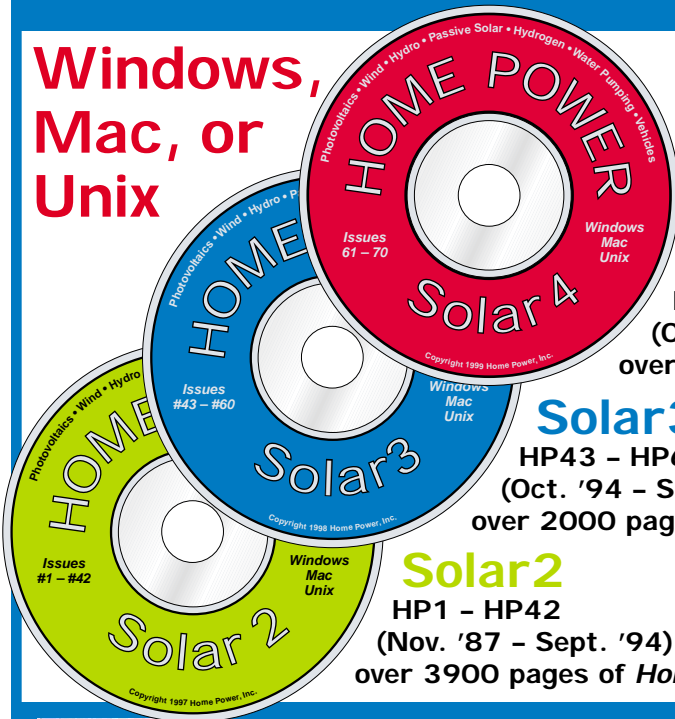

For credit card orders call Home Power at 800-707-6585

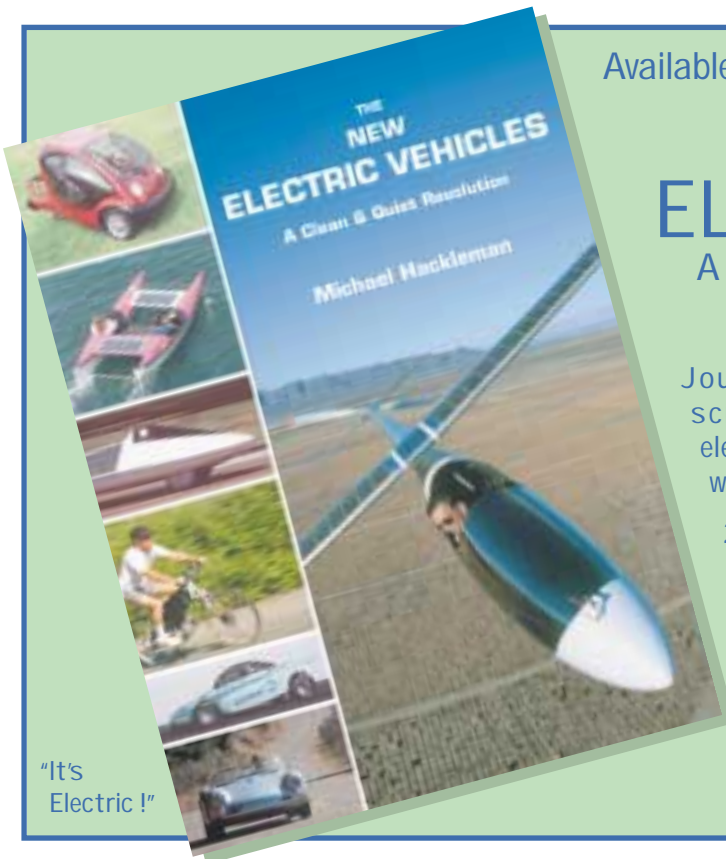

Available Now! Only \$25 (outside USA add \$10 for air-mail shipping)

THE NEW ELECTRIC VEHICLES

A Clean & Quiet Revolution

by Michael Hackleman

Journey into the world of conversions, scratchbuilts, human-electrics, solar cars, electrathon racers, planes & boats—all powered with electricity.

272 pages of EV technology, 465 photographs (over half in color), and detail on 65 vehicles. Includes 115 technical design and construction sidebars.

To order Call: 800-707-6585

Outside USA call 541-512-0201 • Fax: 541-512-0343

or write to:

Home Power Publishing
PO Box 275 • Ashland OR 97520

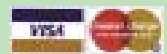



SOLAR2000

*Solar Powers Life
Share the Energy*

**June 16-21, 2000
Madison, Wisconsin**

Presented by the

American Solar Energy Society

American Institute of Architects
Committee on the Environment

American Society of Mechanical
Engineers Solar Energy Division

Hosted by the

Midwest Renewable Energy Association

For information contact:

American Solar Energy Society
2400 Central Avenue, Suite G-1
Boulder, CO 80301
303-443-3130

e-mail: ases@ases.org
web site: www.ases.org



Working Renewable Energy Systems on Site

Open to the Public

| | |
|-------------------|-------------|
| Friday, June 16 | 9 AM – 7 PM |
| Saturday, June 17 | 9 AM – 7 PM |
| Sunday, June 18 | 9 AM – 5 PM |

Over 100 exhibit booths displaying and selling renewable energy equipment, sustainable living supplies, earth friendly products, books, videos, and more.

Offering more than 100 workshops on:

- Solar Electricity • Wind Electricity
- Solar Cooking • Sustainable Living
- Solar Hot Water Systems • Masonry Stoves • Organic Gardening • Straw Bale Construction • Alternative Transportation
- Batteries and Inverters

Activities and entertainment for the whole family.

11th Annual Midwest Renewable Energy Fair

***June 16-18, 2000
Dane County Expo Center Madison, WI***

For information contact:
Midwest Renewable Energy Association, 7558 Deer Road, Custer, WI 54423
715-592-6595, E-mail: mreainfo@wi-net.com, web site: www.the-mrea.org



EV Batteries:



Cost, Care, & Feeding

Shari Prange

©1999 Shari Prange

There's good news and bad news about electric vehicle batteries. The good news is that there are batteries actually in production and available that will allow your car to travel a thousand miles or more on a single charge. The bad news is that they would cost you tens of thousands of dollars, and would have to be replaced two or three times a year.

My point is that almost anything is possible, but a lot of things aren't practical, once you look at the costs and other penalties. This is very relevant when you are shopping for EV batteries. You must first look at the specific characteristics, and put them into four categories:

- These are the battery characteristics I must have.
- These are ones I would like to have.

- These I can tolerate if necessary.
- These are absolutely not acceptable.

The issues we'll look at this time are cost, cycle life, charging requirements, maintenance, self-discharge, performance, and mounting options.

Dollars and Sense

In *HP72*, we talked about battery range, physical dimensions, and weight, because these are often make-or-break issues. First, you must compare possible battery systems, and see if any of these will physically fit in your car and give you the range you need. If not, then you must consider whether you can use a different chassis, or reduce your range needs. Once you have identified some battery setups that will give you the necessary range and fit in your car, you must determine whether they will also fit in your budget.

Let me start with a few general words of warning. Stay away from bargain batteries at your local discount warehouse. You have no way of knowing who actually manufactured them and how good they will be in an EV. A bargain that doesn't work is no bargain.

Your best bet for good dollar value is to get as close to the manufacturer as possible. The same battery, re-labelled by a brand distributor, might cost you as much as 30 to 40 percent more than if you had bought it from a factory distributor. If you can find someone who sells wholesale or in quantity to fleets, you can eliminate one level of markup. Since you will be buying perhaps a dozen and a half to two dozen batteries, these people are often willing to sell to you. If you call the battery manufacturer, they should be able to direct you to retailers and wholesale distributors in your area.

Prices can vary quite a bit from one dealer to another, and in different localities. The accompanying chart will give you some general ranges, but you will need to research local sources.

Comparing Prices

Now you need to multiply cost per battery times the number of batteries in a pack to compare total battery cost among different potential setups. For example, a flooded 6 volt battery from U.S. Battery or Trojan might cost US\$60. A 96 volt pack of sixteen of them would cost US\$960. A 96 volt pack of twelve 8 volt batteries from the same manufacturers, at perhaps US\$70 each, would be only US\$840.

But you may have discovered from your earlier research that this pack won't give you the range you need. If you use sixteen of the 8 volt batteries to get close to the same range as the 6 volt system, you now have a 128 volt pack costing US\$1,120. This pack will also give you a higher top speed. In general, prices go up with individual battery voltage. A 12 volt battery costs more than an 8 volt, which (sometimes, but not always) costs more than a 6 volt.

Maintenance-free 12 volt batteries, such as those from Optima and Hawker Energy Products, will cost more than flooded 12 volt batteries. In addition, you will have to use two packs of these in parallel to achieve a similar AH capacity to a same-voltage pack of flooded 12 volt batteries. You would need three packs to approach the capacity of 6 volt or 8 volt packs of the same voltage. You need to factor this into your calculations.

You can see how the maintenance-free (also called "sealed") batteries can become very expensive very quickly. However, this cost is reduced if your range needs are small. If your available battery space is also small, they may be well worth it. You can sacrifice range that you don't need without giving up speed. They also have some other advantages we will discuss a little later.

Cycle Life

Bill O'Brien, EV specialist for Hawker Energy Products, says that "a battery is a live thing, always changing. It is



A cutaway view of a Trojan T-105 6 volt lead-acid battery.

very accurate to say that a battery is born and it dies." This is actually another aspect of the cost issue. How long will the batteries last before the pack needs replacement, assuming good care? You might speculate about how long you expect to keep the vehicle, and project battery costs over that time span.

It's very difficult to get cycle life numbers. While batteries may have factory claims for several hundred cycles, even the factory representatives will hedge and qualify their statements. This is because many things affect battery cycle life, and bench tests bear little resemblance to real life. The most important factor is depth of discharge. If you routinely drive close to your car's maximum range, the batteries will die faster than if you give them shallow discharges and then recharge them.

This may affect how you design and use your car. For example, you might want to build in more range than you need by using a larger battery pack—perhaps 120 volts instead of 96 volts. Your normal driving will discharge it less deeply, so you will get more cycles out of the pack.

This is also a good reason to charge every night, even if you have only used 20 to 30 percent of your potential range. Keeping the discharge cycles shallow will extend the batteries' life. (These batteries do not have the "memory" problem that many people are familiar with from household nickel cadmium batteries.)

Battery Costs, Cycle Life, & Characteristics

| Characteristic | Flooded 6 Volt | Flooded 8 Volt | Flooded 12 Volt | Sealed 12 Volt |
|--------------------------|-------------------|-------------------|--------------------|-------------------|
| Cost (US\$) | 50-100 | 55-120 | 110-160 | 120-275 |
| Life cycle (years) | 3-5 | 3-5 | 2-3 | 1-2 |
| Requires charge mgmt. | No | No | No | Yes |
| Requires watering | Yes | Yes | Yes | No |
| Self-discharge | Yes | Yes | Yes | No |
| Acceleration | Moderate | Moderate | Moderate | Quick |

Note: cost and life cycle numbers are typical, as reported by users.

The plate compound used in the battery is important to longevity, too. For example, U.S. Battery has developed a proprietary compound that reduces corrosion, which is the number one cause of battery death. Other important factors in cycle life include the charger, battery maintenance, and dormant periods, all of which we'll discuss in more detail a little later.

So how do you make comparisons? You can get a rough idea by looking at the experiences of other home conversion drivers. In general, the traditional favorite 6 volt flooded batteries last 3 to 5 years. The 8 volt batteries have not been used in conversions long enough to have much data, but U.S. Battery says their cycle life should be about the same as that of the 6 volt batteries, if used in the same way. The sealed batteries use a different technology. Users claim these generally only last a year or two in EV conversions.

Chargers

As mentioned earlier, the type of charger can affect battery cycle life. The old crude chargers, and most homemade chargers, simply pour juice into the batteries. They might have timers to automatically shut themselves off. However, this type of charger pays no attention to the batteries' actual condition and needs. It will most likely overcharge and damage the batteries, shortening their life.

Modern commercial chargers sense the batteries' state of charge (SOC), and taper their output accordingly. However, different types of batteries have different preferred charging algorithms, or patterns. It is necessary to have a charger that is matched to the type of batteries you are using.

Charging batteries in series packs is different from charging them individually, too. In a pack, one or two bad cells can cause the overall pack charge to seem low to the charger. The charger doesn't taper off, and the good cells are overcharged and damaged.

Although all battery packs need to have their individual batteries as closely matched as possible, some types of batteries are more forgiving than others. The traditional 6 volt batteries can do well with a commonly available charger with occasional voltage checks of individual units.

The 8 volt batteries can generally use the same type of charger as the 6 volt ones, properly sized to the pack voltage. However, if you change from 6 volt batteries to 8 volt ones, the maximum output current on your charger should be adjusted down accordingly, even though your total pack voltage may be the same as before. This is because the 8 volt batteries have less capacity. The 6 volt charger settings will cause them to gas excessively.

Sealed 12 volt batteries are generally touchier about how they are charged. Most people using these batteries also use some type of battery management system, and some manufacturers require it on large series packs to maintain warranty. These systems monitor individual batteries during charging. When a battery reaches its optimum charge, it is cut out of the circuit of the incoming current. If the batteries you choose require this type of management, you will need to include it in your cost projections. A monitoring system can cost anywhere from a few hundred dollars to more than a thousand.

Maintenance

Flooded batteries require a certain amount of maintenance. Some gassing and fluid loss is a normal part of their charging cycle. Depending on your climate and your vehicle use patterns, you should check the fluid levels and top them off every one to three months.

Incidentally, you probably won't be warned about low fluid by a drop in performance. Since the part that gasses off is water, the remaining liquid becomes more acidic, and your car might actually feel peppier. Only if the level drops below the tops of the plates will you notice a decrease in range. By this time, you are seriously abusing the battery, and the damage may not be reversible.

If you are the type who is likely to procrastinate about battery maintenance, you might want to consider one of the maintenance-free batteries. This might also be a consideration if your battery packs will be hard to access for service.

Because flooded batteries do normally gas a small amount, they are messier than sealed batteries, and require occasional cleaning. If you are fastidious about your car and this mess upsets you, or conversely, if you are unwilling to deal with wiping them down from time to time, you might consider sealed batteries.

As we mentioned in *HP72*, so-called “sealed” batteries are not really fully sealed, and can gas in some situations, but not under normal charging. If they do gas, it shortens their life, because there is no provision for replacing the lost fluid.

However, “conditioning” is important to these batteries. Randy Hively, sales account manager for Optima, recommends a conditioning regimen every other month. This involves 16 hours at a constant current with no voltage limit. You should not do this procedure too frequently, though, as it will also shorten battery life.

Dormant Periods

Another relevant issue in some situations is how well a battery holds up during dormancy. Flooded batteries will self-discharge gradually when they sit unused. Discharging a battery causes lead sulfate crystals to form on the plates. In normal use, these convert back to the charged active material when the battery is charged again.

The crystals formed by a slow discharge, such as that in an unused battery, are larger and more difficult to convert. Eventually, these will impair the batteries’ function. This is called sulfation. If your vehicle is likely to sit unused for long periods, you will need to charge it periodically to protect against this sulfation. This is another situation where you might want to consider sealed batteries.

Sealed batteries have a very low self-discharge rate. In fact, batteries like the Hawker Genesis models are manufactured to be emergency backup power supplies. They are intended to sit unused for months without loss of capacity or damage.

An example of a good application for this type of battery is a race car that will not be used at all for street driving. It will sit dormant between practices and races, but needs to be in top form when it is in use.

Another example would be a cold climate and a car that is only driven once or twice a week. While cold weather does affect flooded batteries, the range loss is minimal if the car is driven daily and charged nightly. Both charging and discharging warm the batteries, and they hold their heat well. However, if the car sits unused, it will cool off and lose range. Sealed batteries are less affected by cold weather.

Performance

This brings us to another battery characteristic—acceleration. This is primarily determined by the internal resistance of the battery. The more internal resistance, the slower the acceleration, and vice versa. Craig Quentin, battery engineer for Trojan Batteries, says that

the Trojan 8 volt has a higher internal resistance than the Trojan 6 volt, which results in poorer acceleration.

The well-known “cold cranking amps” (CCA) ratings for batteries have no application to EVs when talking about range, but they do apply to acceleration. A battery’s CCA rating tells how well it is able to supply and sustain high current, which is exactly what you need to accelerate.

Some secondary characteristics can affect acceleration as well. For example, Nawaz Qureshi, battery engineer for U.S. Battery, points out that between two otherwise identical batteries, the one with heavier posts will give better acceleration due to less resistance in the posts, and therefore higher current flow.

Given the same voltage, speed controller, and vehicle weight, a sealed battery will give superior acceleration to that of a flooded battery. This is due to the different internal design and low separator resistance between the plates. This results in very low internal resistance in the battery, so it is able to release its energy very quickly.

Optimas are the favorites of electric drag racers and high performance EVers for this reason. They refer to this characteristic as “low voltage sag.” If you watch your gauges on an EV as you punch the throttle, you will see the amps climb sharply and the pack voltage fall off. As you come up to cruising speed, these both level out. With a sealed battery, the pack voltage is not drawn down as deeply, so you come up to speed more quickly. For drag racers, the added cost and battery management systems involved are worth the extra quick response.

The more sedate street driver will notice some differences as well. In a conventional conversion with flooded batteries, performance will hold steady for most of the discharge cycle. Toward the end, however, it will gradually deteriorate, with the top speed dropping lower and lower no matter how much throttle you give it.

In this case, if you have miscalculated and “run out” of juice, you can pull off the road and rest the batteries for a few minutes. You will see the pack voltage come up while you sit, as the battery recovers some usable capacity. You can then drive again, and can (in an emergency) repeat this maneuver three or four times if necessary, travelling several more miles. In a sealed battery car, the pack voltage holds steady until the very end of the charge. Then it falls off sharply, and you had better be close to home.

Orientation

There is one other difference between flooded and sealed batteries that may be important in some

situations, especially in vehicles with very limited battery space. Unlike flooded batteries, sealed batteries can be mounted in any orientation, even sideways or upside-down. Also, since they don't need maintenance, you can mount one bank of batteries directly above another with only a small space in between.

Order of Importance

I have tried to present these battery characteristics in the order of their importance to the majority of people. However, this will vary from one person and vehicle to another, and in some cases might be the opposite of what I have laid out.

You should set up your own priorities in order, and use them like multiple sieves to winnow your choices. First, eliminate all batteries that cannot meet your highest priority, whether it is range, cost, performance, or something else. Then take the remaining choices and sift them through your next highest priority.

You may find there is only one choice that meets your "must have" and "not acceptable" requirements, and your decision is made. If you have the luxury of multiple choices, then you can sort them based on your "would like to have" and "could tolerate" priorities.

Coming Up

Now let's take a little peek at the future. Panasonic has developed an advanced sealed lead-acid battery which will be used in future versions of the GM EV1. There is nothing revolutionary in its design. Instead, Panasonic concentrated on the fact that a series of batteries is only as strong as its weakest cell. They have improved their manufacturing techniques so they can reliably maintain much tighter tolerances in production than in the past. A more uniform battery pack means more range and a longer cycle life.

These batteries are only being supplied to manufacturers such as GM now. But if they supplant other batteries in enough applications, they may trickle down to the retail market where you and I could buy them for conversions.

Next time we'll talk about battery technologies other than lead acid.

Access

Shari Prange, Electro Automotive, PO Box 1113-HP, Felton, CA 95018-1113 • 831-429-1989
shari.prange@homepower.com • www.electroauto.com

Hawker Energy Products, Inc., 617 N. Ridgeview Dr., Warrensburg, MO 64093 • 800-730-7733 or 913-362-4898 • Fax: 913-362-3993 • info@hepi.com
www.hepi.com

Optima Batteries, 17500 East 22nd Ave., Aurora, CO 80011 • 800-292-4359 or 303-340-7440
Fax: 303-340-7474 • sales@optimabatteries.com
www.optimabatteries.com

Trojan Battery Co., 12380 Clark St., Santa Fe Springs, CA 90670-3804 • 800-423-6569 or 562-946-8381
Fax: 562-906-4033 • Technical: Jim Lee, Applications Engineer, phone ext. 301 • j.lee@trojan-battery.com
www.trojan-battery.com

U.S. Battery Mfg. Co., 1675 Sampson Ave., Corona, CA 91719-1889 • 800-695-0945 or 909-371-8090
Technical: Nawaz Qureshi, VP of Engineering, nqureshi@usbattery.com • www.usbattery.com



NO HASSLE WIND POWER

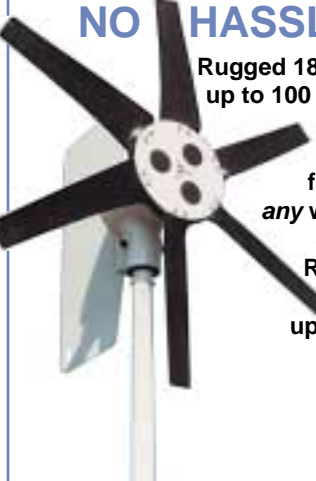

Rugged 18" blade Ampair 100 produces up to 100 Watts *continuously*, 24 Hours per day, at wind speeds from 8 to 100+ mph. No brakes or furling needed...guaranteed at *any* windspeed! Veteran of 3 years *continuous* Antarctic service. Roof mount is OK; pole mount is better. Put it up, hook it up to the batteries and forget it!

Jack Rabbit Energy Systems
425 Fairfield Ave., Stamford, CT 06902
(203) 961-8133 • FAX (203) 961-0382
e-mail: jackrabbitenergy@worldnet.att.net

NO-HASSLE WATER POWER



If you have a reasonably fast running stream or tide nearby and 12" of water clear, Aquair UW Submersible Generator can produce 60 to 100 Watts *continuously*, up to 2.4 KWH per day. **NO TURBINES, NO DAMS, NO PIPES!** Water speed 5 mph (brisk walk) = 60W. 8 mph (slow jog) = 100W. Timber, rock, or natural venturi increases output.

12 or 24 VDC

T-SHIRTS

Guerrilla Solar



Install by Night—Power by Day

On Black: \$15, or Camo: \$18
International orders add \$5 for air shipping

Call, see our web site, or send check or money order
800-707-6585 (541-512-0201 Outside USA)
www.homepower.com

Home Power, PO Box 520, Ashland, OR 97520

100% Cotton
Good Shirts!

T-Shirts

Sizes:
S, M, L, XL, XXL

Full Color
on Natural Shirt
\$15.00



International
orders
add \$5 for
air shipping

To Order Call: 800-707-6585

(541-512-0201 Outside USA)

Or see our web site:
www.homepower.com

Or send check or money order to:
Home Power Magazine
PO Box 520, Ashland, OR 97520

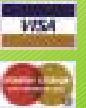

**Why are Linda & Carl Bauer
(up front with Mikaila)
still getting Home Power?**

**Because the visitors
to their home during the
1998 Tour of Solar Homes
reminded them to**

Check Their Mailing Label

**You won't miss an issue of
Home Power either. The
number of the last issue in
your subscription is printed
on every issue.**

Snorkel Stove Company

b/w

3.5 wide

4.5 high

New Product Announcement

Mark IV - 20 Amp Solar Regulator

Extend battery life by protecting batteries from overcharge

Digital voltage & current display flips every 10-15 sec.
Color battery voltage gauge

20 Amp capacity (four to five solar modules)

5 year warranty

SOLTEK provides a full range of alternative energy products

SOLTEK
SOLAR ENERGY LTD.

Independent energy solutions since 1986

US distributor & dealer inquires welcome



Chris Hanson, International Sales Manager with the internal components of the Mark IV (above). Mark IV's new look for 2000 (below).

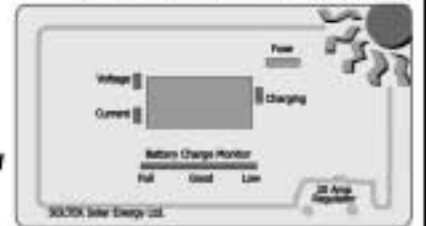

#2 - 745 Vanalman Avenue
Victoria, B.C. V8Z 3B6
Website: www.soltek.ca
E-mail: soltek@soltek.ca

Canadian Toll Free: 1-800-667-6527

Call: 1-250-727-7720

Fax: 1-250-727-2135

Are Alternative Energy Prices Turning Your Budget UPSIDE DOWN?

At Solar On Sale our one and only goal is to put alternative energy products in the hands of the masses, where they belong, for the lowest prices possible!

Trace SW4024 \$2279.00
Heart 2 KW w/ Charge \$719.00
ProSine PS 2.5-12 \$1739.00
ProSine PS 3.0-12 \$2099.00
Trace DR3624 \$1099.00
Kyocera KC120 \$549.00
Trace PP-SW4024/S \$3299.00
Trace DR1512 \$699.00
Photowatt 75 watt PV \$315.00
BP-585 Laser Grooved PV \$429.00

Kyocera KC80 PV \$366.00
Staber Washer \$1149.00
BP 75 watt PV \$350.00
Air 403 Wind Generator \$499.00
Prosine 1000 Inverter \$599.00
Danby Propane Fridge \$859.00
Vector 600 Inverter \$109.00
Kyocera KC60 PV \$285.00
Photowatt 95 watt PV \$395.00
Solar Boost 50 MPPT \$279.00



BP SOLAR

SOLAR ON SALE

Toll Free 1-888-64-SOLAR (76527)

<http://www.solaronsale.com>



Contact us
for volume discounts

SunLine Solar

Starting at **\$29.95**

Phone 1-800-886-4762 • Fax 717-351-0383

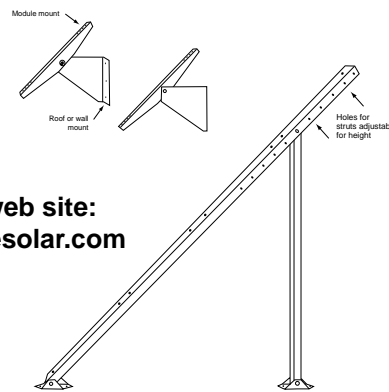
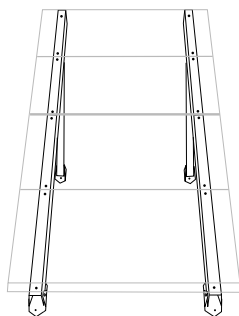
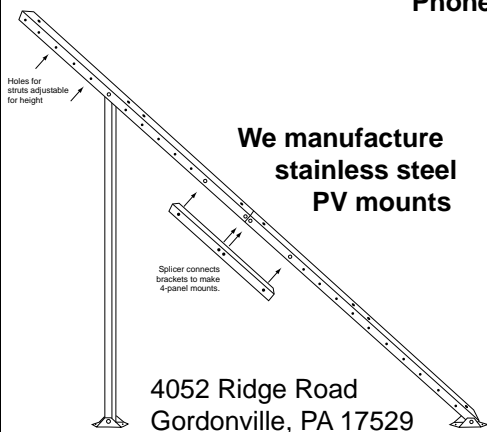

Visit our web site:
www.sunlinesolar.com

Take the Guesswork Out of Power Measurement

- easy to use
- reliable
- accurate
- affordable



Things that Work!
Home Power #67

Richard Perez, in his review of the 4-1850 Brand Digital Power Meter for *Home Power*, said, "This is the first time that I have wished for more than two thumbs, 'Both Thumbs Up!'"

BRAND DIGITAL POWER METER

- Measures overall power consumption and cost of operation.
- Use to measure 117 VAC circuit loads up to 1850 watts and determine sizing requirements for backup power supplies and circuit protection.
- NEW! Snap on current Transducers now available! Ratings from 500 watts to 10,000 watts.
- Brand Electronics ships customized units on a routine basis. We welcome an opportunity to discuss your power measurement applications; AC or DC; any voltage, current, or plug configuration.

Call today! To order, call toll free 24 hrs.

1-888-433-6600

<http://www.brandelectronics.com>

Model 4-1850: Watts, kW-hrs, User Cost, & Average Monthly Cost.

Model 20-1850 and 20-1850CI: Watts, kW-hrs, User Cost, Average Monthly Cost, Amps, Volts, Power Factor, Vars, V-A, & Peak Watts.

Model 21-1850CI: Data logging unit with Model 20 capability plus on board memory to accumulate data over prolonged periods for download to computer.

Price: 4-1850 = \$149.95, 20-1850 = \$249.95, 20-1850CI = \$299.95, 21-1850CI = \$349.95

Price includes domestic shipping and handling. CI = Computer Interfacing; includes RS-232 interface, cable and software. Maine residents add 5.5% sales tax.



Brand Electronics

421 Hilton Rd., Whitefield, ME 04353

For information only, call 207-549-3401 • Fax 207-549-4568

email: info@brandelectronics.com





Mike Brown

©1999 Mike Brown

“I want to build an electric vehicle with a gasoline-powered range extender. Can you supply the parts and instructions?”

This question comes up again and again, in various forms. Another version is, “Why can’t I put a Honda generator in my EV’s trunk and not have to worry about the limited range on batteries alone?”

The Honda-generator-in-the-trunk is a popular EV “urban legend.” Like some of the common mainstream urban legends, such as the poodle in the microwave oven and the alligators in New York City sewers, the genset in the trunk is possible, but not likely to happen.

Definition of Terms

These questions refer to what is known as a hybrid electric vehicle, or HEV. This is an EV that has an internal combustion (IC) engine to supply part of the energy needed to power the vehicle.

There used to be two different types of hybrid, defined by how the power from the engine gets to the road. In one type, the IC engine drives a generator or alternator, which charges the battery pack, which powers an electric motor, which drives the wheels that live in the car that Jack built. This is called a series hybrid, because the EV and IC systems are configured, one behind the other, in a single, continuous drive system.

In the other type of hybrid, both the EV and the IC systems are capable of driving the wheels directly. They may function independently, with the car operating as either an EV or as an IC at any given time. Or they can both run together, combining their power to move the vehicle. This is called a parallel hybrid, because there are two complete drive systems side-by-side in the same drivetrain.

Then, just to confuse things, Toyota brought out the Prius, in which the engine drives the wheels *and* charges the batteries, making it a series-parallel hybrid. Honda’s Insight appears to be a series-parallel hybrid also. But these two examples are the products of major auto manufacturers’ R&D departments, and possibly a little beyond the resources of the average home converter. So I’ll limit this article to the traditional series hybrid and parallel hybrid.

While we’re defining things, I’d like to point out that the correct terms are IC “engine” and EV “motor.” If you keep this distinction in mind, it will help avoid confusion.

Series Hybrid Issues

Before we go any further, we should put the generator-in-the-trunk myth where it belongs—with the poodle and the alligator myths. In this instance, the speaker really means to say “genset.” This is a commercially produced unit that includes both the generator, which actually makes the electricity, and the engine needed to run the generator.

In theory, the generator would provide roughly the same amount of energy that the car was using in cruise mode. If the battery pack was partially discharged, the incoming current would recharge it. If it was full, the current would “float” over the battery pack to run the drive motor. The batteries would only “lose” energy during acceleration, when demand exceeds the generator’s output.

To get an idea of the electrical output required by an EV in cruise mode, we can look at my Voltsrabbit. At 60 mph (97 km) on the freeway, the motor is drawing 200 amps. Electricity flows from higher voltage to lower voltage, the same way water runs downhill. In order to overcome the battery pack’s voltage (96 volts, in this case), we need about 120 volts. Multiply the volts (120) times the amps (200) and you get 24,000 watts, or 24 KW.

The largest Honda generator I could find is a 10.5 KW unit that puts out 120 volts at 87.5 amps AC, and costs US\$3,899. The problems with this unit are many. First, its output is alternating current, which means that it would have to be rectified to direct current. Second, it is 3 feet long by 2 feet wide by 2 feet high (90 x 60 x 60 cm), and weighs about 400 pounds (180 kg). This is a little big for the average EV trunk. Third, its noise level is 78 decibels. So much for a quiet EV.

Fourth and finally, it has only half the output needed, so for all its size, weight, noise, and electrical problems, there isn’t enough output to boost your range significantly. So you can see that what seems at first glance to be the simple, logical, and easy approach to a series hybrid falls into the “possible but not likely” category.

If you want to build a series hybrid from scratch, your first task is to find a suitable generator or alternator and an engine to power it. The generator has to have more than twice the output of the genset described above, which had a 20 horsepower (hp) engine, so you need at least a 40 hp engine. This is equivalent to an old VW Bug engine, which is about right. Energy is energy, and this is how much it takes to move a car. Expect to pay

at least as much as the cost of the genset mentioned above for your engine and generator.

With your generator and engine in hand, you need to find room for them, in addition to the complete electric drive system and at least ten 12 volt batteries. The hybrid allows you to use smaller batteries, but not to reduce the total pack voltage. Your system voltage limits your rpm, which means speed. If you lower the pack voltage, you reduce performance.

The space available for these items is reduced by the necessity of leaving the fuel tank and exhaust system in place to accommodate the hybrid's engine. If your engine is liquid-cooled, leave the car's radiator in place. If the engine is air-cooled, you will have to duct air to it and provide an exit for the hot air given off by the engine. An additional task is the design and fabrication of a load-sensing speed control for the engine.

Some people have suggested putting the engine, generator, and fuel supply on a small trailer to overcome the space problem. This is a logical solution to the problem and has been done successfully. This scheme has the additional advantage of letting you choose to make your EV a hybrid only when you need the additional range.

The disadvantages are the extra expense of the trailer and the dynamics of driving with one. In addition to the extra length involved, which limits your parking options, backing up with a trailer is a skill that is not easily learned.

Parallel Hybrid Issues

As I stated above, in a parallel hybrid, the IC engine drives the wheels directly. This system eliminates the generator's expense, bulk, and possible lack of availability, but it still requires installation space, cooling, fuel supply, and an exhaust system for the engine. Finding an engine with enough horsepower and torque, yet small enough to fit in the limited space available, will require some searching.

The real problem, however, is getting the power to the wheels when it is needed. As in a conventional car, the engine needs to be disconnected from the wheels when the car is stopped and the engine is still running. In addition, it needs to be disconnected when the car is being driven by the electric motor with the engine off.

For the parallel hybrid I built, I first tried the biggest electromagnetic clutch I could find, and promptly burnt it up. I guess a 3,000 pound (1,360 kg) hybrid pickup truck was too much of a load for a garden tractor PTO clutch. I finally ended up using a six-plate dry clutch from a Norton motorcycle, modified to fit my hybrid drive system. Locating or designing and fabricating a

suitable clutch is one of your biggest challenges when building a parallel hybrid.

In my parallel hybrid, the electric motor and the gas engine drove the rear wheels of the truck through the truck's original transmission. This is the way most parallel hybrids are set up.

Another approach that has been tried is to have the electric motor drive one set of wheels and the gas engine drive the other set. One crude but effective example involved a Ford Escort in which the front-wheel-drive IC power train was left in place. In the rear, the builder grafted the rear sub-frame from a VW Squareback, complete with suspension, transmission, and electric motor and adaptor to provide the electric drive.

The car had two shift levers, a common clutch pedal that operated both clutches at the same time, and a gas pedal that was attached to both the carburetor and the electric drive's potbox. It worked. The builder drove it down to see me from Lake Tahoe. The only problem he had was that the weight of twelve 6 volt golf cart batteries under the hatch in the back of the car, combined with the heavier Escort chassis, was too much for the VW wheel bearings, which had to be replaced before he could go back to Tahoe.

Clarence Ellers, one of the early members of the Electric Auto Association and a genuine EV pioneer, built two similar hybrids. One was based on an Aztec 7 kit car, and the other was based on a Chevy Lumina van.

Both of these hybrids had the front wheels driven by the electric motor and the rear wheels driven by an IC engine. The front electric drive went through a transmission, and was used to propel the car during low speed around-town driving.

In the rear, the engine drove the drive axle directly, using a clutch that disconnected the engine when it was not in use. The engine supplied power only at highway speeds or on hills above a certain pre-set speed. All of this was made possible by a control system that Clarence developed and patented. Before you ask—he never would tell me where he got his clutch.

Common Issues

There are problems that both types of hybrids share. The first is exhaust emissions. The genset mentioned earlier puts out the same amount of pollution as thirty emission-controlled cars. Any engine you use will probably have to conform to the smog laws in your area or you won't be able to register it.

Then there's what automotive engineers call NHV: noise, harshness, and vibration. Unless you are careful

to duplicate the original motor mounts for your added-on IC engine, you will feel it when it's running. The car's stock muffler may work for your smaller engine, but there is a chance it might be too restrictive and cost you power. Finding the right muffler could be a chase. Another problem is that adding an IC engine brings tune-ups and oil changes back into your life, adding expense and waste disposal problems to the equation again.

Despite all of the above, I am not saying that either type of hybrid can't be done. Functional hybrids have been built by college teams competing in Department of Energy sponsored contests. A few dedicated hobbyists have built hybrids too. What I am trying to say is that if you want to build a hybrid, be prepared to spend a lot of time, effort, and money on the project. It is not as simple as it may seem. You need to evaluate whether the actual benefits of the hybrid will outweigh the drawbacks for you.

Thanks for your letters, emails, and questions. If you have had experience building a hybrid EV, I would like to hear how you addressed these challenges, and how it worked out.

Access

Mike Brown, Electro Automotive, PO Box 1113-HP, Felton, CA 95018-1113 • 831-429-1989
 Fax: 831-429-1907 • mike.brown@homepower.com
 www.electroauto.com



CHANGE THE WORLD
 Affordable On-Grid Solar Electricity

- ASE module with integrated 250-watt Advanced Energy utility-tie inverter
- Simple installation - no dc wiring, just connect to your load center
- Affordable - start with one, expand in the future without rewiring
- PC monitoring card option
- UL listed, American made



With our partner, Advanced Energy Systems, we offer you the tools to change the world, wherever you live, on-grid or off. Visit us at www.solarvt.com or www.advancedenergy.com

SOLAR WORKS, INC.

64 Main Street, Montpelier, VT 05602
 Tel: (802) 223-7804 Fax: (802) 223-8980



SOLAR CONVERTERS INC.

We manufacture power supplies for the renewable energy industry.

New Products

- 60 amp. Power Tracker™ charge controller with MPPT and voltage conversions
- Constant Voltage Pump Driver with integral LVD and Float Switch Control
- Voltage Controlled Switch - a simple relay switch for many uses

Triple your power savings!

- Use our products with maximum power point tracking to get all the power that you paid for.
Typically you only get 53 watts of performance from a 75 watt panel.
- Our proven technology is combined with voltage conversions, which allows you to connect to high voltage panels using smaller wire, again saving cost.
- Use the cost effective high voltage panels and really save on your system.

Also, our usual large selection of LCB's, Cathodic Protection Controllers, DC to DC Converters and more.

Highly efficient, reliable, low cost. Call your local dealer!

SOLAR CONVERTERS INC.

C1-199 Victoria Road South Guelph, Ontario N1E 6V1 Canada
 Ph. 519-824-5272 Fax. 519-823-0325
 Email: info@solarconverters.com Web: www.solarconverters.com

SUNBURST SOLAR PRODUCTS
 Tucson, AZ

SPECIALIZING IN SOLAR ELECTRIC POWER SYSTEMS

WHOLESALE SPECIALS

All modules UL approved, new full spec., min. order 2 modules

- Millennia (43 Watt Thin Film Module) \$199
- BP-275 (75 Watt Module) \$369
- BP-585 (85 Watt Laser Grooved) \$419
- ASTRO (120 Watt Module) \$559
- SB50 (Solar Boost 50 amp MPPT) \$289
- AIR-403 (400 Watt Wind 12,24,48V) \$529
- TS512SB (500 Watt Inverter/charger) \$349
- SW4024 (4000 Watt Inverter/charger) \$2339
- PC 250 (Trace Power Center) 1,049
- Power Panel SW4024S w/C40 \$3499

H
U
G
E
S
A
V
I
N
G
S

O
R
D
E
R
T
O
D
A
Y
!

- BP SOLAREX • TRACE ENGINEERING•
- WATT SUN Trackers • TWO SEAS Mounts•
- S.W. WINDPOWER • RV POWER PRODUCTS•

Phone (520) 546-3166 FAX (520) 546-3162

Visa/MC

Amex/Discover

Email sunburst@azstarnet.com

Our website has free information on "Using a battery monitor to help maintain your battery system, conserve energy and troubleshoot problems." The TriMetric TM-2020

For beginning or intermediate level, our website explains the basics of "volts", "amps", and "amp-hours" for people who are new to electricity. We have information on maintaining your batteries and hints on minimizing your generator usage. The website also describes how the TriMetric measures the energy content of your batteries. We list complete TriMetric instructions, information on shunts, and troubleshooting meter installation problems. Some files are in "Adobe Acrobat" format. Or mail us \$1 for postage and we'll send it to you the old fashioned way!



Measures: battery volts, amps, % full (based on amp-hours), battery lifetime total amp-hours, highest and lowest battery voltage, days since fully charged, and days since equalized. Mounts in standard "double gang" box (optional).

Under \$200 including shunt.

BOGART ENGINEERING

19020 Two Bar Road, Boulder Creek, CA 95006

(831) 338-0616

www.bogartengineering.com

Wind & Sun

Serving customers around the world for over 20 years

Partial list of manufacturers

Astropower - Unisolar - Kyocera - Solarjack & Sunrise submersible pumps - Thin-Lite - Concorde AGM batteries - Siemens panels - Two Seas Mounts - Solarex
Deka Industrial batteries - Surrette batteries - Trace - Statpower - Morningstar - BP Solar - Shurflo pumps - Exeltech - TriMetric - Zomeworks tracking mounts
Fire Wind & Rain maximum power point trackers - Solar Converters Inc. - Heliotrope - Delta Lightning arrestors - Dankoff solar pumps – and many others.

End of Year Sale

These prices good through October, 1999 - See our web sites for many more specials.

Siemens SP75 - 75 watts, 25 year warranty: \$365 each for box of 2 or more

Kyocera KC120 - 120 watts, 20 year warranty: \$585 each

Unisolar US64 - 64 watt thin film triple junction: \$309 each

Trace SW4024 or SW4048 4kw sine wave inverter: \$2395

All trace SW power panel systems on sale – up to 30% off!

Trace DR3624 3600 watt modified sine wave inverter: \$1139

Trace DR2424 or DR2412 2400 watt modified sine wave inverter: \$995

Trace TS512SB Tiger series 500 watt with charger: \$369

BP Solar BP275 75watt, 20 year warranty, \$375

Prices do not include shipping. We accept all major credit cards.

Get our set of 3 - Catalog, Solar Design Guide, and Solar Water Pumping Guide for only \$7.50 postpaid.

See our online catalog and complete guides to solar at www.windsun.com

www.solar-electric.com (online store)

Northern Arizona Wind & Sun, Inc.

Phoenix, AZ

888 881-6464 - Fax: 623 872-9215

2725 E Lakin Dr., Flagstaff, AZ 86004

800 383-0195 - Fax: 520 527-0729



Renewable Energy Terms Inverter— Device for Converting Direct Current into Alternating Current

Ian Woofenden

©1999 Ian Woofenden

Derivation: After asking people in the inverter industry, I can still only speculate on why an inverter is called an inverter. Some people said that it describes the reversing of DC polarity when making the AC waveform. But other folks could not make a direct correlation between the common meaning of the word "invert" and the name "inverter."

Inverters take direct current (DC) electrical energy and turn it into alternating current (AC) electrical energy. DC

electrical energy can be stored in batteries, while AC cannot be effectively stored. Inverters allow us to store energy in batteries, and then use it in standard 120 VAC appliances. Before we had inverters, we could use only DC appliances in our RE systems. Access to common, full-featured, and inexpensive appliances is the prime reason to add an inverter to your system.

When it comes to advising newcomers, I generally recommend going to a primarily AC system. It's still worth considering running some special loads (refrigeration is high on this list) on DC, even though this complicates the system. I've lived for over 15 years with a three voltage (12 VDC, 24 VDC, and 120 VAC) system, and I wouldn't wish this madness on anyone. Inverters help make renewable energy a mainstream technology, since they allow renewable energy equipment to power standard 120 VAC appliances.

By adding just a little more PV and sizing your battery bank just a bit larger, you can compensate for the inefficiency of the inverter and use simple, reliable, and conventional electrical power. Then you won't have to turn your life upside down to use renewable energy.

Access

Ian Woofenden, PO Box 1001, Anacortes, WA 98221
Fax: 360-293-7034 • ian.woofenden@homepower.com



Y2K BLOWOUT!!!

UNI-SOLAR™ Roofing Shingles



\$79/\$65 (Quantity 30+)

* SHR15S 15watt, 6 volt, unbreakable, flexible, second, 20 year warranty by SEI!

Lowest Prices Under the Sun!

DC-AC Inverters

140 watt \$29 or 2 for \$38
500 watt \$89 or 2 for \$158
1300 watt \$299 (.09mA idle)

Flexible Panels (2nds)

MBC131 5 watt \$59
MBC262 11 watt \$99
MBC525 22 watt \$149
USF32S 32 watt \$199

Rigid Panels

US42 42watt \$189
US64 64watt \$289



Solar Electric Inc. 1-800-842-5678

5555 Santa Fe St. #D, San Diego CA 92109 858-581-0051, 858-581-6440 fax
www.solarelectricinc.com email: solar@cts.com

ELECTRIC VEHICLE

COMPONENTS, CONVERSION KITS, PUBLICATIONS, VIDEOS, AND ENGINEERING DESIGN SERVICES FOR THE EV HOBBYIST AND MANUFACTURER...All components selected with safety and reliability foremost in mind....We stock and sell the largest variety of the very best:

- ◆ ADVANCED DC Motors in 9 variations from 2 HP to 28.5 HP
- ◆ CURTIS-PMC Controllers, Throttle Potboxes, Footpedals
- ◆ ALBRIGHT ENG. Main & Reverse Contactors in 6 models
- ◆ GENERAL ELECTRIC & HEINEMANN Circuit Breakers
- ◆ BUSSMAN Safety Fuses from 200 to 800 amps
- ◆ DC-DC Converters from 48 to 200 V input
- ◆ K & W ENG. & BYCAN Battery Chargers from 48 to 144 V
- ◆ Full line of CURTIS, WESTBERG, & KTA Meters & Gauges
- ◆ DELTEC Meter Shunts from 50 to 1000 A
- ◆ EVCC Adapter Plates, Couplings, Clamps, & Brackets
- ◆ PRESTOFLEX Welding Cable, MAGNA Lugs, Assy. Tools
- ◆ CONVERSION KITS for vehicles from 300 to 5000 lbs.
- ◆ Complete ELECTRATHON Drive & Instrumentation Pkg.
- ◆ 4 Complete GO KART kits...for up to 90 mph..

KTA SERVICES INC.

COMPONENTS & PUBLICATIONS CATALOG.....\$5.00
Electric Vehicle components and systems since 1984

944 West 21st Street – Upland, CA 91784 USA

Tel: (909) 949-7914 – FAX: (909) 949-7916

Web: www.kta-ev.com

NEW! REVOLUTIONARY! WHITE LED LIGHTING SYSTEMS

LED Lights last 100,000 hours

LED Lights use 1/10th of the power

**Unique Designs – Pathway
& Landscape Lights**

Complete systems for new or retrofit

LED Lights available in both AC & DC

**LED Lights can be used indoors
and outdoors**

FREE BROCHURE

DEALER PRICING AVAILABLE

A Premier Manufacturer of Quality Solar Products

SUNAMP POWER COMPANY

7850 E. Evans Rd., S-104



Scottsdale, AZ 85260-6919



1-800-677-6527

Integrate Your Balance of System

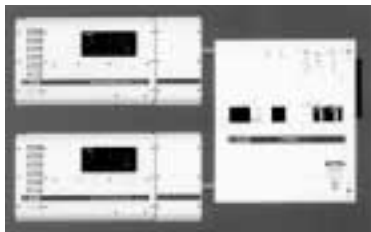

**New PC250 & PC500
Power Centers from:**



UL Listed PC250 & PC500 Power Centers Include:

- Single or Dual 250 Amp Inverter / Battery Main Breaker
- DC Rated Photovoltaic Array Input Circuit Breaker
- AC Section with Input / Output / Bypass Breaker
- 60 Amp PWM Photovoltaic Array Charge Controller

Trace Inverter / Power Center Combo Packages Now Available!
Call ETA Engineering Toll-Free at 1-877-964-4188
or visit us on the web at: www.etaengineering.com

**ETA
ENGINEERING**

**RENEWABLE ENERGY SYSTEM
DESIGN & DISTRIBUTION**

2010 E. University Dr., #11, Tempe, Arizona, 85281

Toll-Free: 1-877-964-4188 Fax: 1-480-966-1516

Creative Energy Technologies BLOW-OUT SALE



Tankless
Water Heaters

Models: 125X \$609, 125B \$499, 125BS \$609, 170 \$899



AIR 403
12 or 24 volt
Land Wind generator \$499



Refrigerators
BSKF375 \$949,
SE215 \$649



Solarex MSX 120
120 watt solar panel \$549



SW4024
sinewave inverter / charger,
4 kilowatt, 24 V, \$2389

SIEMENS SR100
100 watt solar module \$489

check us out on the web at: www.cetsolar.com
Or call for our catalog 888-305-0278 Toll-Free



10 Main St.,
PO Box 149, Summit, NY 12175



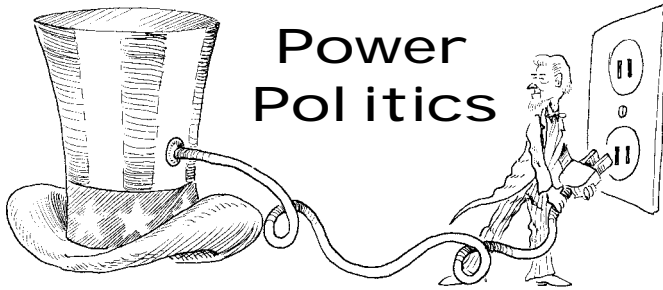

Buried in News

Michael Welch

©1999 Michael Welch

Wow! Since *HP73* was finished, I have been inundated with news from around the world.

For the last couple of weeks, every day I've seen new info that made me think, "I should be doing my column on this." And then the next day, "No, this is what I should write about."

Japan's Deadly Nuclear Accident

I wish I could report that all the news is good, but some pretty horrible stuff is happening. Most important is the disaster at the uranium processing plant in Tokai-mura, Japan (JCO, Inc. which is owned by the huge, multinational Sumitomo Company). There've been some decent accounts of the accident in the mainstream media, so I'll just try to fill in some blanks.

Nobody is dead yet, but it is assumed that the three workers exposed most directly to the uncontrolled reaction are as good as dead. All three were airlifted to the National Institute of Radiological Sciences, east of Tokyo, in order to treat their acute radiation injuries. They seem to have inhaled a high concentration of uranium gas.

According to Tokyo's Citizens' Nuclear Information Center (CNIC), "It is said that the 49 workers and area residents have been exposed. However, this is not a number based on examinations for various types of exposure. The examination was conducted to detect exposure by neutrons, and thus relates only to the number of people who had sodium24, that is produced by neutron exposure, in their bodies."

About 150 people from 39 households were evacuated from the area immediately surrounding the plant. A "Declaration of Safety" was issued by the government

saying that the area within a 350 meter (1,150 ft) radius of the site had no contamination and thus they would call off the evacuation request. However, CNIC did not believe that the government had enough information to release such a declaration.

All trains and other mass transportation were curtailed. The taking of drinking water from the Kuji River was suspended. A temporary ban on coastal fishing was put into place. Agricultural products from within a 10 km (6 mile) radius were recalled from market.

The Chief Cabinet Secretary, Mr. Nonaka, said that Japan is faced with an unprecedented crisis. The government was considering seeking help from the U.S. military in the country to help cope with the situation. The Prime Minister, Mr. Obuchi, decided to postpone the reorganization of his Cabinet that had been proposed for October 1st.

With limited information at hand, CNIC is convinced that there were significant releases of radioactive material into the environment. But only time will tell how much. There was not as much released as there was in the Chernobyl accident in 1986. But even if it was a thousandth of the size, it could mean the eventual death of hundreds of locals, and render useless thousands of acres of farmland.

The big question is whether we will we ever know the whole truth. Even today, the nuclear industry denies that any more than a handful of Ukrainians died as a result of Chernobyl. But The Ukraine Ministry of Health estimates as many as 125,000 deaths in the Ukraine and reliable news sources estimate deaths at 7,000 in Russia as well.

While on the Subject of Russia

There seems to be a witch hunt going on for environmental activists in Russia. According to the St. Petersburg Times, "Over 130 international observers representing environmental organizations from all over the world—including two members of the European Parliament—sent an open letter Sunday to Russian law enforcement authorities protesting what they say was the illegal detention of one of Russia's leading environmentalists."

"Vladimir Sliviyak, the director of Ecodefense's anti-nuclear campaign, said he was forcibly detained September 6 near his Moscow apartment building, pushed into an unmarked car, and interrogated for 90 minutes by four people in civilian clothes who said they were police officers." The officers claimed to be investigating the recent bombing of a shopping center.

Sliviyak said, "90 percent of their questions concerned my environmental activities." He added, "They said that

the people who are related to terrorism are all also related to environmental organizations [and] ...that all terrorist acts can be traced back to ecological organizations." Sliviyak also claimed that one of the officers showed him some marijuana and threatened to plant it on him if he did not answer questions.

In a related case, the Russian government is trying to deprive another environmental activist of his right to a proper defense. In 1996, Russia's Federal Security Service arrested Alexander Nikitin for allegedly divulging Russian state secrets in a report about the Russian navy's careless handling of its nuclear waste. After continuing prosecution of Nikitin over these years, now they are going after his attorney, Yuri Shmidt.

When the Russian Federal Service for Currency and Export Control (VEK) declared "invalid" the contract Nikitin signed with his lawyers, Shmidt said, "This decision...is an open attempt to deprive Nikitin of a right to defense or to force [his] lawyers to work for free." Nikitin's contract transfers his wages to pay for his legal defense, but VEK apparently intends to freeze those accounts so the attorneys won't have access to the defense funds. The move comes just before Nikitin's tentatively scheduled trial date of November 23.

Word is getting out about Russia's continuing corruption after the fall of communism. Our own nuclear industry has corrupted the U.S. government, and things seem to be just as bad in Russia.

In Turkey via Canada

Turkey may soon have the technology it needs to become yet another nuclear power. Who's next—Greece? According to the Nuclear Awareness Project, on October 15th, government officials in Turkey will announce who will build their two new nuclear power reactors. The first is slated for Akkuyu Bay, situated next to an active fault line. The Akkuyu region has experienced a number of strong earthquakes over the past 100 years. But earthquakes are not the biggest problem involved in this scenario.

The Canadian government is negotiating the sale of two CANDU-type nuclear reactors to the Turkish government. Canada has directly contributed to the proliferation of nuclear weapons by providing a nuclear reactor to India. India has built upgraded reactors based on what Canada provided, and has produced plutonium. The sale of these Canadian reactors to Turkey would arm that country with the same technology that India and Pakistan used to build nuclear bombs.

The Mohawk Nation via Russia & the USA

The latest plan for getting rid of plutonium from U.S. and Russian dismantled nuclear weapons is to mix it

with processed uranium and burn it in Canadian nuclear reactors. The "mixed-oxide" (MOX) fuel seems gently named for what it really is—a dangerous cocktail of some of the deadliest substances known to humans.

"Burning up" plutonium sounds like a good idea until you find out that using MOX fuels in reactors gives you even more plutonium than you started with. The only possible advantage is that bomb-grade plutonium would be somewhat harder to process out of the used fuel than before it was "burned" in the reactor.

U.S., Russian, and Canadian activists are working hard on all fronts to stop this insane idea. Atomic Energy of Canada plans to transport the materials, including plutonium, to a test reactor at Chalk River west of Ottawa. The shipment from the United States would enter Canada by truck at Sault Saint Marie, while the Russian cargo would travel by ship along the St. Lawrence Seaway before docking at Cornwall.

Early in October, Mike Mitchell, Grand Chief of the Akwesasne reserve said that if diplomacy and the courts fail to stop the shipment, Mohawks would resort to "massive human resistance." Asked if they would be capable of blocking the St. Lawrence Seaway, Mitchell replied, "Yes."

Native chiefs from the large Kahnawake and Akwesasne reserves said that the nuclear accident in Japan on September 30th highlights the potential danger of the delivery. "One little molecule, one little gram, can cause enormous damage. We found that out in Japan," said Mitchell. "One little mistake and you have an international health problem. We don't want that coming to Canada."

I don't know about you, but I am looking forward to seeing the Canadian indigenous people kick some butt.

Back to the U.S. for some OK News

President Clinton made his feelings about the Yucca Mountain nuclear waste site clear—sort of. In an October press release, he said, "Yesterday's nuclear accident in Japan is a tragic reminder that we must do everything in our power to ensure safe, responsible handling of radioactive materials. Upon reviewing Senate Bill 1287, regarding potential nuclear waste disposal at Yucca Mountain, I have determined that it would not adequately ensure the protection of public health and safety. If this bill is presented to me in its current form, I will veto it."

He continued, "I am encouraged that this latest Senate bill, the Nuclear Waste Policy Amendments Act of 1999, does not seek to authorize interim storage of nuclear waste at Yucca Mountain before a thorough scientific analysis of the site has been completed. That would be

an unconscionable mistake, and I have consistently opposed such proposals in the past. However, the bill would take away the existing authority of the Environmental Protection Agency to protect public health and safety. It is vital that this authority be preserved."

Congress has been seeking to remove the EPA's influence from the Yucca Mountain project as they feel it will more easily move forward without it. The EPA's rules are more stringent than the DOE's. This is a good reaffirmation of the administration's position, but our supposedly anti-nuclear President should just come out and say, "Yucca Mountain is a bad idea. We will not be spending any more taxpayer funds on it."

The Best News

My solar panels are working great.

NIRS Matching Grant Will Triple Your Donation

In *HP70*, I told you about a matching grant that Nuclear Information Resource Service obtained. If you donate \$100, the value of your donation to them is \$300. Their grant expires on January 1, and they are only 60 percent of the way to the US\$200,000 maximum. Please send them a contribution as soon as possible and triple the effectiveness of your gift. NIRS does incredible work, supporting international, national, and local projects that make a definite difference for a safe energy future. They need your help right away.

Access

Author: Michael Welch, c/o Redwood Alliance, PO Box 293, Arcata, CA 95518 • 707-822-7884
michael.welch@homepower.com
www.igc.org/redwood

Citizens' Nuclear Information Center, 3F Kotobuki Bldg., 1-58-15 Higashi-nakano, Nakano-ku, Tokyo 164-0003 Japan • 81-3-5330-9520 • Fax: 81-3-5330-9530
cnic-jp@po.iijnet.or.jp • www.jca.apc.org/cnic

ECODEFENSE!, Moskovsky prospekt 120-34, 236006 Kaliningrad, Russia • Phone/Fax: +7(0112)437286
ecodefense@glasnet.ru
www.indifference.demon.co.uk/ecodefense

Mike Mitchell, Akwesasne Grand Chief, Mohawk Council of Akwesasne, PO Box 579, Cornwall, Ontario K6H 5T3 Canada • 613-575-2250 • Fax: 613-575-2884

Joe Norton, Kahnawake Grand Chief, Mohawk Council of Kahnawake, PO Box 720, Kahnawake, Québec J0L 1B0 Canada • 450-632-7500 • Fax: 450-638-5958
general@nck.ca

Nuclear Awareness Project, PO Box 104, Uxbridge, Ontario L9P 1M6 Canada • Phone/Fax: 905-852-0571
nuaware@web.net

Nuclear Information and Resource Service (NIRS), 1424 16th St. NW #404, Washington, DC 20036
202-328-0002 • Fax: 202-462-2183 • nirsnet@igc.org
www.nirs.org



NEVER BE POWERLESS AGAIN!
RENEWABLE ENERGY SOLUTIONS

- Wind Power
- Microhydro
- Solar
- Independent Power Systems



HUMAN POWERED GENERATOR

Easy to Use
Economical
Dependable
Fun!

Pedal Your Way to Energy Independence!

TEL 802-658-0075
FAX 802-658-1098

WINDSTREAM POWER SYSTEMS INC.
PO Box 1604 HP, Burlington, VT 05402
25 Years in Business

e-mail: info@windstreampower.com
website: www.windstreampower.com

Palouse Wind & Water

1011 Rothwell Road, Viola ID 83872
208-883-3676 or fax 208-883-3298
pwindh2o@moscow.com

1 Completely Remanufactured 10KW-12.5KW to 15KW Jacobs Wind Turbine. Complete 90' tower or 70° Rhone tower Hinged base, UTILITY INTERCONNECT model, can be modified for OFF Grid, UTILITY INVERTER + CHOKE, Onan 20 KW Alt, Finned Gear Head – No Blades – 6 mo Warranty—Installation By Contract. Qualifies for Fed TAX Incentives and does Qualify for Calif Buy Back Program.

\$11,000

Also (1) 40 VDC 2500 Watt Jacobs Short Case
Call For Pricing, with tower
Plus TAX, Shipping, and extra for OFF Grid

New BULLDOG Generator Sets

Diesel, Propane & Natural Gas
Local Service Support
No Waiting Six Months for Parts



New 3.5 KW Diesels from: \$1,795
(not model shown)

BOWERS POWER SYSTEMS

Seattle, Portland & San Francisco
Ph 800-858-5881 • Fax 888-246-2935
www.bowerspower.com

SIEMENS

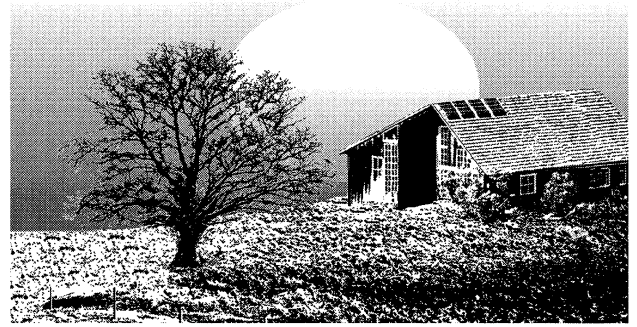

Solar Power Your Dream.

You've finally found just the right spot. A little out of the way, but good water, good soil, and even a little view. You're going to build.

Find out now just how easy it is to have a solar system to meet all or part of your electrical needs.

See Your Siemens **SolarPowerPro™**

Siemens can help turn your plans into reality. An economical Siemens solar system can give you year after year of trouble-free electricity. And do it silently, without fuel, waste or pollution.

Office (520) 636-1001

Fax (520) 636-1664

P.O. Box 365, 2655 N. Hwy 89
Chino Valley AZ 86323



HITNEY SOLAR PRODUCTS, INC.
Harmony with Nature



Vari-Fan

The most versatile
DC-powered ceiling fan
ever offered.

See more at our Web site:

www.fanworks.com

e-mail: **info@fanworks.com**

or write:

RCH Fan Works

2173 Rocky Creek Rd.

Colville, WA, USA 99114

Fax (509) 684-5199

Dealer Inquiries 1-800-529-6306

"I consider (the PowerPulse® devices) to be standard equipment for a lead-acid battery system..."

Richard Perez, Home Power magazine



Eight ounces of prevention!

**Extend the
life of your
batteries!**

12 Volt \$69.95* 24 Volt \$119.95*

Accept no substitutes; the cost effective PowerPulse® units are patented, approved by the U.S. Military, and have a 10-year limited warranty.

*Manufacturer's suggested retail price. Other voltage units available.

- Free delivery to 50 States. ■ Major credit cards OK.
- Bulk/Dealer inquiries invited.

Abraham Solar Equipment

800-222-7242 ■ 970-731-4675

124 Creekside Place ■ Pagosa Springs, CO 81147

©1999 Abraham Solar Equipment. All rights reserved.

THE POWER BROKERS!™



Things That Used to Work—Bugs in IEEE 929

Don Lowebug

©1999 Don Lowebug

As many readers know, over the last year and a half IPP has commented on the IEEE 929 standard for interconnecting PV systems to the utility grid. Engineers from utilities and inverter companies have spent many hours developing this standard. The purpose of the standard is to simplify the interconnection of small inverters (under 10 KW) used in net metering systems. However, on the eve of its adoption, a major snag has cropped up.

IEEE stands for the Institute of Electrical and Electronics Engineers, and the publication is *Recommended Practice for Utility Interface of Photovoltaic (PV) Systems*. The first paragraph of the new version of IEEE 929 says, "This recommended practice contains guidance regarding equipment and functions necessary to ensure compatible operation of photovoltaic systems which are connected in parallel with the electric utility. This includes factors relating to personnel safety, equipment protection, power quality, and utility system operation."

The new version of IEEE 929 will require inverter companies to upgrade their products to meet the new standard. They will need to adjust voltage and frequency trip points to those required in the standard, and to add an anti-islanding scheme that will assure that the inverter does not energize a line that the utility has de-energized (because of a fault or for maintenance).

In late spring, anticipating the adoption of the new standard, one of the major inverter companies announced the availability of an upgrade chip that would meet the new standard. Unfortunately, when the chip was installed, a very high percentage of the upgraded inverters would no longer operate reliably in the grid-interactive mode. Suddenly simplification had become complication!

Start at the Beginning

I need to back up a bit and tell the story as it unfolded for my customer, Jack, and his family. Jack lives in central California in a rural area served by Pacific Gas and Electric (PG&E). Unlike another major California utility, Southern California Edison (SCE), PG&E has created numerous barriers to the installation of net-metered PV systems.

For example, SCE does not require a separate, redundant, "visible, lockable, physical disconnect," while PG&E does. SCE has streamlined its application process, sending all applications through a single, knowledgeable individual, and allowing the process to be completed through the mail. PG&E requires a site visit and inspection by a safety engineer (most often not familiar with California state law regarding net metering). I explained these additional barriers to Jack so he would be prepared for the bureaucratic hurdles ahead. As a retired Marine colonel, Jack understood the need for procedures, and absolutely wanted to go "by the book."

The Usual Hoops

After Jack's system had been signed off by the local building inspector and he had received his California PV rebate, Jack phoned PG&E and formally applied for a Net Metering Interconnection Agreement. The local PG&E representative said that they would "get back to him." Several days later, he was contacted and an appointment with a field representative was made. At the meeting at Jack's home, the interconnection agreement was provided. It was also decided that Jack would need to install an additional "visible" disconnect. Jack, not wanting to put in the wrong switch, asked for a specific recommendation (manufacturer and model number). The field representative did not have specific information but said he would find out. Jack proposed that we install a "pull out" disconnect that was lockable.

The field representative said he thought that would be okay.

The Rules Are Changed

At this point, we were feeling pretty good. We were told that the signed contract would be returned in a few days. Then came what would turn out to be a major problem. The head protection engineer in San Francisco wanted to see the inverter's certificate of compliance. This was a first for me. I knew of many installations done throughout the PG&E service area that had not required the certificate. However, I didn't see this as a problem, since every inverter is shipped with a certificate.

The certificate was provided and immediately rejected. PG&E now required a different specification! Keep in mind that the old specification had been used since 1994. In lieu of a certificate, we were told that we could upgrade the inverter to the new upcoming (but not yet final) IEEE 929 standard. Jack, being very patient, had me order the software upgrade for his inverter. When the chip arrived, it was installed. We were, to say the least, very disappointed when the inverter would not stay connected in grid mode.

This was a real "Catch 22." Jack could have net metering if he would install a chip rendering his inverter useless for net metering! So now Jack is in limbo. Having run the gauntlet of obstructionistic utility policy and a capricious and czarist protection engineer, Jack still cannot do what California state law says he can do.

Finger Pointing

I contacted the manufacturer to find out what was going on. I was dismayed when told that quite a few "upgrades" were having problems but that the new chips were IEEE 929 compliant and the customer needed to call the utility and have them correct their "over voltage" problem. I contacted another inverter manufacturer and they too were having problems with IEEE 929. This company had, in fact, voted against the standard precisely for this reason.

All our efforts—working to get net metering laws passed that stipulated a simplified interconnection process and promoting simplified interconnection standards—have been sabotaged if customers must request special voltage adjustment from their utilities! Instead of removing barriers, IEEE 929 (as proposed in the current draft version) has created barriers.

What's Wrong?

IEEE 929 needs fixing. Fortunately, it's a simple fix. But before going into the why and how of it, we need to examine what I'd call the special environment of distributed generation (DG) and why IEEE 929 creates problems.

Just as the name implies, DG is dispersed. It is spread throughout the network of wires, substations, and loads that collectively make up the power distribution system. DG is co-mingled or imbedded with the load. This is a markedly different topology from utility generation, which is centrally located and relatively far away from the load. The traditional utility model reflects this structure when reference is made to generation, transmission, and distribution as the main components of a utility. This fundamental structural difference between DG and central generation clearly dictates that standards for DG reflect the special environment for DG applications.

Utilities Regulate Voltage

Because central generation is often a great distance from the loads, utilities must use a number of methods to regulate the voltage delivered to the customer. Utilities must compensate for the voltage drop (an unavoidable physical reality) that occurs between source and load. Adding more complication to the task is the fact that not only distance but also the amount of load affects voltage drop. And the load changes throughout the day. Therefore, voltage can vary significantly at the load. The existence of a multibillion dollar power quality (PQ) industry is a testimony to this fact. In many ways, DG should be seen as a subset of the PQ industry because PV systems deliver PQ benefits!

Voltage drop is regulated by the utilities in several ways. Of utmost importance is voltage regulation at the source, hence tight voltage standards are applied to generation. Within the distribution system, many transformers are used. By adjusting "taps" on the transformer windings, voltage can be controlled at various points in the system. Some of these adjustments are made automatically while others are done on an as-needed basis by a lineperson, usually in response to customer complaints.

As a general rule, utilities like to run voltage slightly high. One reason is that low voltage is more damaging than high voltage. By keeping voltage high, utilities compensate for the inevitable voltage drop that occurs when loads come online. Another reason utilities run voltage high is that revenue is enhanced. My own field tests in rural central California found average utility voltage to be from 1 to 4 percent high.

DG Stabilizes Voltage

We now shift focus to the details of distributed generation, specifically DG that is covered by IEEE 929. These generally are customer-owned PV systems under 10 KW. For some perspective, a residential service panel rated at 200 amperes (typical for new construction) has a capacity of 48 KW. The incoming

grid capacity is almost five times greater than the maximum outgoing PV capacity.

You should also understand that we are not talking about wind farms or PV subdivisions here. These RE systems are spread out and dispersed throughout the utility system. In California, the net metering law even limits the total amount of interconnected capacity to one tenth of one percent (0.001) of utility capacity. Also keep in mind that the inverter is connected to on-site loads. Generally only a fraction of its output is fed back to the grid. From the perspective of a small inverter pushing power back into the grid, the grid looks *very* big. There is no way the inverter can upset the voltage on the grid—it's the other way around. The inverter follows the grid voltage that is presented to it. The best an inverter can do is get out of the way (disconnect) if voltage gets too high.

This voltage value should be based on protection considerations. Here lies the problem with IEEE 929. Its upper voltage limit is based on a central generation standard that addresses regulation issues. Put another way, IEEE 929 leaves insufficient headroom for an inverter that must operate in the context of DG, a context characterized by fluctuating utility voltage that tends to be on the high side.

A Safe Voltage Range

A range of 108 to 132 VAC has long been the accepted value for safe residential grid voltage. This represents a range of plus or minus 10 percent. Most grid-connected inverters have operated within this range for years. To my knowledge, no small inverter operating within this range has ever damaged a customer's electrical system or disturbed the utility distribution system.

The Squeeze Is On

The proposed IEEE 929 has lowered the upper limit to 127 VAC! This value is only 6 percent above the nominal value of 120 VAC. Recall that my utility survey shows that voltage can routinely be up to 4 percent high. The IEEE 929 upper limit of 6 percent clearly causes problems since it leaves only 2 percent headroom for other variations. It's as if the new standard was designed to monkey wrench net metering. I am mindful of the fact that the IEEE 929 committee had inverter representation and only one manufacturer voted no. Frankly, some parties have been asleep at the wheel on this one, including me.

More Information

Is it reasonable to expect an inverter to operate within that remaining 2 percent window? I don't think so. But to help me better understand the issues, I invited Bill Brooks of PVUSA to come to Jack's site and document it with his lab equipment. In the course of that visit, we

had a chance to talk about some other reasons that an inverter might trip off.

One reason has to do with how an inverter is installed. Depending on the wire size between the inverter and the main service panel, the inverter may have to elevate the voltage in order to push power back onto the grid. This may require a 1 to 3 percent increase above the grid value. This is not an out of spec or abnormal situation. This extra voltage never appears on the grid, but it's a voltage that the inverter must produce to make up for voltage drop. However, the inverter "sees" this voltage, and if this voltage is on top of a 4 percent high grid value, the inverter may trip off. Another thing we know: No voltmeter or voltage detection system is 100 percent accurate. There will always be some inaccuracy. Another 1 to 2 percent here would not be abnormal.

Do The Math

Now, let's add up these percentages: 4 percent high grid, plus 3 percent voltage drop on the inverter connection, plus 2 percent voltmeter error. This gives us a value of 9 percent higher than nominal—the inverter will trip off grid. But the actual voltage applied to the grid is *not one bit higher* than what the utility is delivering! It's obvious that a 6 percent IEEE 929 value is too low because it causes false trips. In order to accommodate normal utility equipment and installation variations, a 10 percent tolerance is required. This is what has been in effect for years. It has worked very well. Why fix what is not broken?

Reduce Barriers

If IEEE 929 is not to become yet another barrier to PV and distributed generation, the voltage window must be returned to plus or minus 10 percent. One inverter manufacturer suggested an interesting counter-solution. He suggested as an alternative to increasing the voltage window, that utilities guarantee an exact 120 VAC to the customer. If they could do that, inverters could easily work within the 6 percent voltage window.

Perhaps DG, and especially renewable DG, is too important to be left up to just engineers and the economic concerns of utilities. Remember, every KWH of site-generated energy is a KWH of energy not sold by the utility. Control issues are always at the fore when monopolies are involved. In fact, as I witnessed the work on IEEE 929, I noticed a constant tendency to tighten voltage windows, decrease trip times, reduce frequency limits, and impose very complicated anti-islanding schemes. Yet this degree of control may not be appropriate for DG. Could technical barriers to DG be erected in order to limit the economic impact of non-utility owned DG?

A New Paradigm

DG represents a paradigm shift. I have already detailed some of the differences between DG and central generation. On a broader, conceptual level, DG has characteristics similar to information and neural networks (flow occurs in many directions). Distributed systems have attributes that are defined by system behavior, which is determined by how the system is interconnected and its topology rather than by individual sources.

Entrainment and synergy effects become operant. As an example of entrainment, consider a network of oscillators all connected to one another. Though an individual oscillator may have a sloppy frequency, the network will pull to a central tendency, a frequency in this case that will be very stable. The same analysis can be applied to voltage. In short, a distributed system has characteristics that are more stable than the sum of its parts.

Renewables as a Social Imperative

There is another more important reason that renewable DG can not be left up to engineers and utilities. Don Harris of Harris Hydro uses the term "social imperative." He believes, as do many others, that we are on the brink of environmental catastrophe and that we can not rely on institutional responses. In times of extreme transition, concerted action by individuals will be needed to exert the leverage required for change. I would add that part of the change is technology driven.

Average people now have the means to produce their own renewable energy. In this context we understand the guerrilla solar movement as an appropriate response by citizens acting on behalf of the greater good. Don Harris also pointed out the ultimate and most effective response to utility imposed barriers when customers self-generate is to disconnect from the utility! This idea is not that far-fetched. I know of two cases where customers chose to bypass utility connection, though available, because of the utilities' use of nuclear fuel. Another customer, already connected to the utility, chose to have the wires removed. Ed Burckhard's story was detailed in *HP29*. That system is now over 15 years old and remains offgrid.

Interconnection Newsletter

Chris Larsen at the North Carolina Solar Center edits a monthly newsletter on interconnection issues. It is free and delivered by email. *Home Power* readers interested in chronicling the good and bad news regarding DG and utilities should check this out. Especially alarming trends are developing in Florida, and with New York's Long Island Power Authority. The policies at these utilities are clearly meant to obstruct DG.

Special Thank You

An anonymous donor has made available to IPP money for ten *Home Power* subscriptions to be placed in California libraries. Thank you for your generous support. IPP will consider reader suggestions for candidate libraries in California.

IPP Web Site

IPP's Web site is being remodeled. Goals for the site are to update our mission statement, archive IPP articles, and provide member links, downloadable logos for members, lists of members, and more content. In general, the site will be more useful and dynamic. We will also have our own domain name. These changes will take a few months. Suggestions from members are welcome.

Editor's note: At press time, it appears that the working group of the IEEE has now reversed its decision and will use the 132 volt upper limit that has been the de facto standard since 1994. We're happy to see this sensible limit get official approval for the very first time, and appreciate the considerable efforts that the utility and PV members of the P929 working group made to get this change into the standard.

Access

Author: Don Loweberg, IPP, PO Box 231, North Fork, CA 93643 • 559-877-7080 • Fax: 559-877-2980
don.loweberg@homepower.com
www.homepower.com/ipp

Bill Brooks, PVUSA, PO Box 354, Davis, CA
530-753-0725 • Fax: 530-753-8469
billb@endecon.com • www.pvusa.com

Don Harris, Harris Hydroelectric, 632 Swanton Rd.,
Davenport, CA 95017 • 408-425-7652

IREC's Interconnection Newsletter, Chris Larsen, North
Carolina Solar Center, Box 7401, NC State University,
Raleigh, NC 27695-7401 • 919- 515-3480
Fax: 919-515-5778 • eclarsen@unity.ncsu.edu
www.ncsc.ncsu.edu

Institute of Electrical and Electronics Engineers (IEEE),
445 Hoes Ln., PO Box 1331, Piscataway, NJ
08855-1331 • 732-981-0600 • Fax: 732-981-1721
ieeusa@ieee.org • www.ieee.org



Wood Fired Water Heaters

**For Homes, Cabins, Camps, Remotes,
Solar Booster, Hot Tubs, Pools, Greenhouses!
USA Made • 3 Models • 10 Yr. Warranty**

Hot Products, Inc. • Dept. HMP • 300 Broadway • Eureka, CA 95501
Tel: (707) 444-1311 • Fax (707) 444-1380 • www.hotpro.com

Vermont Solar Engineering

800.286.1252 - fax 802.863.7908

*When Y2K goes away,
we'll still be here.*



We pride ourselves on being a hands-on dealer/installer, selling what we know to work well from down-to-earth experience. We didn't arrive on the scene yesterday, and won't disappear after the sale, either. So if you're looking for support from a company *not* riding the Y2K cash cow into the sunset, please give a call.



The Chargeboost™ Transformer squeezes the maximum current from a modified sine wave inverter's battery charger. If your charger & generator are not performing well together, you'll be impressed with the results. **Starting at \$129**

3 KW Auto-toroid™ Transformer, A high efficiency, UL listed, lightweight 120/240 volt step-up toroidal unit. Includes 20a, dp circuit breaker on output. Factory wound for Vt. Solar. **\$299**



Surrette KS21 2v, 1000 ahr battery
Designed for maximum cycles and infrequent watering. Expected to last 15+ years in service, this battery has a 10 year warranty (3 years unconditional, 7 years pro-rated), and is among the toughest, longest lasting lead acid you'll find anywhere.



12 vdc 1000 ahr string (6 cells) **\$1,259**
24 vdc 1000 ahr string (12 cells) **\$2,496**



*...Other
Surrette
Batteries*

CH375-L16
6v, 375 ahr,
5 year warranty.
\$ 189

T12-250
12v, 250 ahr, 7 year warranty.
\$ 239

Trojan T-105
6v, 220 ahr
\$65



Model 2020 Bogart TriMetric meter
a customer favorite –
only **\$169** including shunt
and shipping !!

Servel Propane Fridge

This refrigerator offers spaciousness, a base mounted control panel, and temperature control. Piezo igniter, flame safety valve, and combined electric and gas thermostat. 8.0 cubic feet.



\$1049

Solar Modules

Siemens SP75 75 watt (17v@4.4a) **\$ 399**
Siemens SR100 100 watt (17v@5.9a) **\$ 495**
AstroPower AP1106 110 watt (16.7v@6.6a) **\$ 529**

Protect your Investment !! **Delta Lightning Arrestors**
LA 302 R (ac protection) . . . **\$ 29**
LA 302 DC (dc protection) . . **\$ 39**

← ** SHIPPING EXTRA except where indicated →

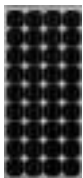

Vermont Solar Engineering
PO Box 697
Burlington, Vt. 05402

Hands-on dealer / designer / installer of the best in renewables since 1991
Call or visit our on-line catalog for excellent Siemens and Trace Pricing
www.vtsolar.com



PLANET DC

Now! RParts carries Planet DC refrigerators and freezers. We have everything to meet all your refrigeration needs at RPrices. Guaranteed lowest.

Call 800-720-3907 for a brochure

RPARTS

REFRIGERATION PARTS SOLUTION

P.O. BOX 5633 BERKELEY, CA 94705-0633
(800) 720-3907 (510) 436-3962 FAX (510) 533-5605
refparts@refparts.com www.rparts.com

BATTERY BOX VENTILATOR

& BACK DRAFT DAMPER



- Positive hydrogen venting
- Stops back drafts
- Keeps batteries warmer
- Increases battery capacity
- Minimal power consumption
- Available in 12, 24 or 48 VDC
- * Trace SW Inverter or controller required

Power Vent \$79
+ \$7 S&H (cont. U.S.)
CO residents add 3%
Specify 12, 24 or 48V
(48V vent \$104)



C.C. Solar Technologies
POB 52, Salida, CO 81201
719.530.0718
Or Ask Your Local R.E. Dealer

WE WROTE THE BOOK ON ELECTRIC CAR CONVERSIONS

CONVERT IT How-To Manual

by Michael Brown with Shari Prange

Expanded & Updated 3rd Edition
\$30.00 tax & postage included

"We built Mr. Brown's car,
and we won." Bruce Burk,
St. Johnsbur Academy,
1991 American Tour de Sol
Open Class Winner.

www.electroauto.com



ELECTRO AUTOMOTIVE
POB 1113-HP, FELTON, CA 95018

Zomeworks

b/w
on film

3.4 wide
4.5 high

Power when the sun goes down...



WINDSEEKER
12 years of proven technology

Rated 500 Watts
Only 22 lbs. (10 kg)
Rotor Dia. 60" (1.5 m)
2 Year Warranty
Internally Regulated
High Wind Applications

Southwest Windpower
2131 N. First Street
Flagstaff, AZ 86004
Ph (520) 779-9483 Ext 11
Fax (520) 779-1485
dept11@windenergy.com
www.windenergy.com

SOLAR PANELS

| | |
|---------------------|-----------|
| CANROM-7(7Wp) | \$ 78.00 |
| CANROM-20 | \$ 132.00 |
| CANROM-40 | \$ 268.00 |
| CANROM-50 | \$ 329.00 |

CANROM-65 ... \$343.00

| | |
|-------------------|-------------|
| CANROM-75 | \$ 460.00 |
| CANROM-S1* | \$ 706.00 |
| CANROM-S2** | \$ 1,199.00 |

* **Canrom-S1** is a kit containing two Canrom-40 panels, an 8 Amp voltage regulator, aluminum mount with three inclination positions, 60 feet of gauge 10 cable, fuse box on the panel side of battery, and complete installation instructions.

** **Canrom-S2** contain four Canrom-40 panels, a 12 Amp voltage regulator, aluminum mount with three inclination positions, 60 feet of gauge 10 cable, fuse box on the panel side of battery, and complete installation instructions.

CANROM Photovoltaics, Inc.
Call or fax for a free catalog: 716-282-2975
or email using : www.canrom.com

SOLAR WEBB, INC.

"Fueling Your Future"
Southern California

SOLAR WEBB, Inc.



Beat the Heat with our Attic Vent Fan Kits,
Using solar power to keep your house *Happy!*
ONLY \$244.00 for equipment!!!

Order Line: **888-786-9322**

Your Authorized Trace Dealer



Visit our website at: <http://www.solarwebb.com>

Grounding the South Forty

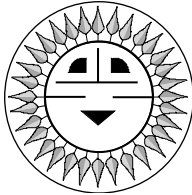

John Wiles

Sponsored by the Photovoltaic Systems Assistance Center,
Sandia National Laboratories

We have been up to our ground rods in grounding in *Home Power 72 & 73*. Here is the last installment on grounding—at least for this year. It will be easy and short, and it will save you money. We are going to ground the PV array that is located away from the building or structure that contains the power center/inverter.

In past *Code Corner* columns, I have hammered on the fact that there can be one and only one bonding connection between the grounded current-carrying conductor (usually the negative conductor) and the ground system. Well, there are exceptions to many requirements in the *National Electrical Code (NEC)*, and this is one of those exceptions.

This alternate grounding method can be used when the following conditions are met:

- The PV array is ground mounted some distance away from other PV components (inverter, batteries, etc.). The distance is not specified in the *NEC*, but I would suggest at least 30 feet (9 m). The PV array may also be mounted on a separate structure as long as there are no conductive paths as described below, including AC power circuits.
- There are no conductive paths (electrical or other) such as water pipes, metal fences, communication circuits, or telephone circuits between the array and the other structure.

If these conditions are met, the PV array may be grounded as follows. The PV modules are connected to the equipment-grounding conductors, as the module instructions require. The module/array tracker frame or rack is also connected to the equipment-grounding conductors, as are any enclosures at the array used for PV source circuit combiners.

These equipment-grounding conductors should terminate at one location—probably a grounding terminal strip in the combiner box. Then, there should be a conductor from this point to the grounding electrode (ground rod). All of this is the same for grounding any PV array. Now comes the difference.

The negative current-carrying conductor is bonded (connected) to the grounding system at the PV array and there is no equipment-grounding conductor run from the PV array to the power center or charge controller. This eliminates the cost and complexity of running the equipment-grounding conductor from the south forty to the power center. The normal negative-to-ground bonding is still required in the power center or ground-fault device (if used).

It should be noted that this grounding method meets the requirements of the *NEC* and is very similar to the grounding of AC circuits in separate structures described in the *Code Corner* column in *HP65*. The figure below shows the connections.

Grounding the Separately Located PV Array

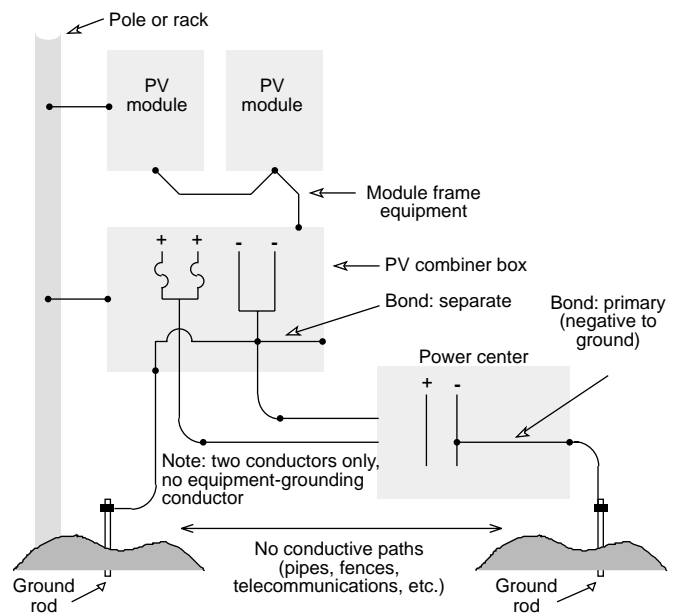

Summary

There are two ways to ground a remote array:

- 1) Meet the two conditions and bond the negative conductor (on a negatively grounded system) to the grounding system at both the array and at the inverter/battery/power center location. Do not run any equipment grounding conductors between the two locations. Use ground rods at both locations. Do not bond ground rods together.

If the two conditions cannot be met, then this method must be used:

2) Do not bond the negative to the grounding system at the array. Bond the negative (on a negatively grounded system) only at the inverter/battery/power center. Run an equipment grounding conductor between the two locations. Use ground rods at both locations.

Check the restrictions listed above. If they are met, eliminate that array-to-power center equipment-grounding conductor and save some money. But don't forget to bond the PV negative conductor to the grounding system at the PV array.

Questions or Comments?

If you have questions about the *NEC* or the implementation of PV systems following the requirements of the *NEC*, feel free to call, fax, email, or write me at the location below. Sandia National Laboratories sponsors my activities in this area as a support function to the PV industry. This work was supported by the United States Department of Energy under Contract DE-AC04-94AL8500. Sandia is a multi-program laboratory operated by Sandia Corporation, a Lockheed Martin Company, for the United States Department of Energy.

Access

Author: John C. Wiles, Southwest Technology Development Institute, New Mexico State University,

Box 30,001/ MSC 3 SOLAR, Las Cruces, NM 88003
505-646-6105 • Fax: 505-646-3841 • jwiles@nmsu.edu

Sponsor: Sandia National Laboratories, Ward Bower, Department 6218, PO Box 5800 MS 0753, Albuquerque, NM 87185-0753 • 505-844-5206
Fax: 505-844-6541 • wibower@sandia.gov
www.sandia.gov

National Electrical Code® and *NEC*® are registered trademarks of the National Fire Protection Association. The 1999 *NEC* and the *NEC Handbook* are available from the NFPA, 11 Tracy Drive, Avon, MA 02322
800-344-3555 or 508-895-8300 • Fax: 800-593-6372 or 508-895-8301 • custserv@nfpa.org • www.nfpa.org

Soares Book on Grounding, US\$38.95 postpaid in the U.S. from International Association of Electrical Inspectors, 901 Waterfall Way, Suite 602, Richardson, TX 75080-7702 • 800-786-4234 or 972-235-1455
Fax: 972-235-6858 • iaie@compuserve.com
www.iaie.com

Wiles, J. C. and Bower, W. I., *Analysis of Grounded and Ungrounded Photovoltaic Power Systems*, First World Conference on Photovoltaic Energy Conversion, Hawaii, 1994



You can turn water into juice using the **STREAM ENGINE**

- Operates at heads of 10 feet & up
- Adjustable for maximum power
- Multiple output voltages
- Output over 1KW
- Easy installation



Epoxy Encapsulated Alternator
Waterproof, Water Cooled,
Neodymium Permanent
Magnets, Brushless,
Reconnectable Windings

Precision Cast Bronze
Turgo Wheel
High Efficiency, High Capacity

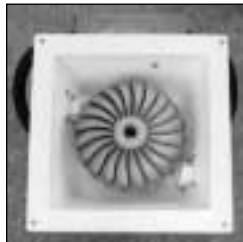

Also Available:

Hydro components including
turgo & pelton runners, system
design, and tech support

"This is a very cool machine. It represents a major breakthrough
in microhydro design." -Bob-O Schultze, Home Power #67

Energy Systems & Design

P.O. Box 4557, Sussex, NB, E4E 5L7, Canada
Tel: (506) 433-3151 • Fax: (506) 433-6151
website: www.microhydropower.com
email: hydropow@nbnet.nb.ca



Things that Work!

\$1695

AUTOMAGIC BATTERY WATERING



WE MAKE WATER FROM YOUR GAS

Hydrogen and oxygen battery gas catalytically recombined into pure water and returned to each battery cell. Keeps battery topped off for extended periods of time and reduces maintenance costs. Explosive hydrogen gas is virtually eliminated from the battery area. Corrosive spray and fumes are contained and washed back into each battery cell. Electrolyte kept strong longer, extending the useful power and life of the battery. HYDROCAP Vents simply replace the battery's caps. Battery maintenance is greatly reduced. Write or call for more information.



Things that Work!

Hydrocap
GAS-FREE BATTERY CARE

305-696-2504
975 NW 95 St.
Miami, FL 33150

Super Efficient • Chest Style • Solar Powerable
Refrigerators & Freezers

2 to 8 cubic feet inside volumes.
 All units run on 12 & 24 Volts DC.

LOW KEEP
 REFRIGERATION

Web & International:
RICHARD
 POB 409, Fennville, MI 49408
 Phone: 616-236-6197
 www.datawise.net/~lowkeep

US Sales:
DAN
 24651 Second Ave.,
 Otsego, MI 49078
 Phone: 616-692-3015

Let Us Build One For You!

EPOWER® Charger / Booster



Prices start at **\$599.95**

- 12V-50, 100, 200 Amp
- 24V-25, 50, 100 Amp
- 38-64 lbs.
- Overload Protection
- Regulated Output
- Safety On/Off Switch
- Extended run LP option available-some models
- OHV engine option available-some models
- We also make a high quality OHV, all copper winding, brushless, 3KW AC generator, 120V or 120/240V

EPOWER
 1346 W- 400S, Albion, IN 46701
 Phone 219-636-2099
 www.epowerchargerboosters.com

3S30 Three Stage PWM Charge Controller

Full featured 3 stage
 30 amp PWM Charge
 Controller for best
 battery performance
 and longevity.
 Complete digital
 metering. Oversized
 #6 wire connectors.



New DSC circuitry for cool efficient operation. Safe for all batteries. Available in 12 and 24 volt models. Easy installation. Available world wide.



B. Z. Products, Inc.
 7614 Marion Ct., St. Louis, MO 63143, USA
 tel: 314-644-2490, fax: 314-644-6121
 email: bzp@inlink.com

Have a South Window?



THE GREENSHELF™
 A Solar Gardening Shelf!

Put that sunshine to work for you growing food and starting seedlings with **THE GREENSHELF™**.

Indispensable year round for herbs, salad greens, succession plantings, house plants and lots more!
 Works great in a greenhouse, too.

Call **1-800-400-2684**
 for free brochure or see online at
www.greenshelf.com

5408 County Road 250 • Durango, CO 81301

Taking advantage of the Kyoto Protocol?

Emission reduction evaluation, certification and certificate trading for renewable energy system owners.



www.icbe.com

Here's a brighter solution!
Forever Titan Solar Light

With an 18 watt fluorescent bulb, it is the brightest solar light on the market.

Fully recharged by the sun and portable, Forever Titan Solar Light is perfect for home, emergencies, camping and recreational activities.

Get your Forever Titan Solar Light (#15/4/10) package for \$189. Call us now to order!
 (Includes lighting fixture, solar panel, and cable. Sales tax and shipping extra.)

PO Box 591495, Dept. H
 San Francisco, CA 94159-1495
 415/831-6184 Fax: 415/831-6127
 www.bellsolar.com

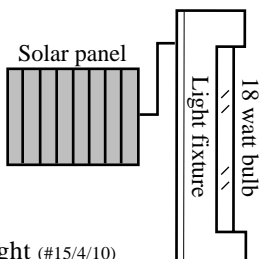

Visa/MC/Discover



SolarRoofs.com

Complete Solar Water Heaters starting at \$895!

FIREBALL 2001
 Y2K Compliant
 PV Options
 Patented Design
 Dealer Inquiries Welcome



Check out these Exciting, Very Easy to Install, & Affordable Systems!

We are Web based: **www.solarroofs.com**
 SolarRoofs.com, Carmichael, CA • (916) 481-7200

NEW ENGLAND SOLAR ELECTRIC, INC.

3 South Worthington Road, PO Box 435
Worthington, MA 01098
1-800-914-4131



This is the most popular book for PV remote homes. It is written and published by New England Solar Electric Inc.

"Best all around book on wiring your PV system."

Real Goods Sourcebook

"Our favorite book for Do-It-Yourselfers."

Windy Dankoff, Dankoff Solar Products

\$16.95 plus \$3 PPS
(includes our \$3 catalog)

"This should become the bible for alternative energy users."

Ken Cox, Trace Inverters

Send \$3 for our 80 page catalog and product guide

Servel/Dometic Gas Refrigerators. Trace Inverters. Trojan Batteries. Siemens & Solarex PV modules, Osram Bulbs. Thinlite Fixtures. Aquastar Hot Water Heaters. AIR 403 Wind Generators

**Best book, most user friendly catalog,
& best kits in the business.**



Danby®

"Good things come in small packages"

Dealer
Inquiries
Invited

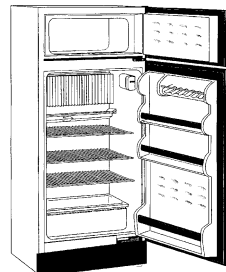

**Propane Refrigerator
DPR2260**

\$995.00

Plus Shipping

- 7.8 cu. ft. Capacity Refrigerator.
- Reversible Door Hinges.
- Door Liner has large, functional divisions, plus a molded Egg Rack.
- Tall Upper Shelf accommodates 1 & 2 gal Jugs.
- 3 Easy-glide Shelves and a Large Crisper.
- Battery Powered Refrigerator Light.
- Automatic Lighter (piezo-electric)
- Automatic Safety Valve.
- European Style Door with Recessed Handles.
- Refrigerator is AGA & CGA Approved.
- No Electricity Needed.

(800) GO-SOLAR (467-6527) sales@energyoutfitters.com
136 S. Redwood Hwy, POB 1888, Cave Junction, OR 97523
Web Page: <http://www.energyoutfitters.com>



www.homepower.com

Backup & Renewable Energy Systems For Homes, Cabins, & Other Applications

- * Solar, Wind, & Hydro
- * Gas, Diesel, & Propane Generators
- * Trace, Solarex, BP, Winco,...
- * Full System Design & Tech Support



Call for our FREE
Info/Pricing Packet
or Order our
"Design Guide" for \$20



Natural Energy Systems, Inc.
1802 Richard Court * St. Paul, MN 55110
Phone: (651) 426-9577
Fax: (651) 407-1353
Email: nes@alternativespower.com
Web: www.alternativespower.com

WATSUN™

SOLAR TRACKERS

The Dual Axis Tracking Advantage
**as compared to a fixed mount tilted at latitude*

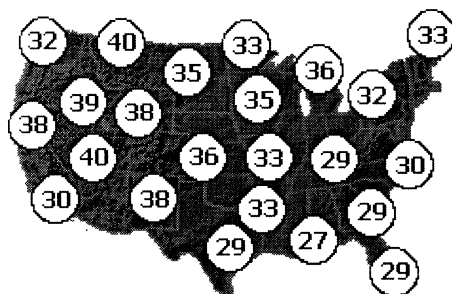

Percent Annual Power Increase

More Power...Less Money

ARRAY TECHNOLOGIES, INC. WWW.WATSUN.COM
3312 STANFORD NE, ALBUQUERQUE, NM 87107
TEL: (505) 881-7567 FAX: (505) 881-7572

Home & Heart



Kathleen Jarschke-Schultze

©1999 Kathleen Jarschke-Schultze

There are a few rules that I live by, and Bob-O has encouraged them as a means of self preservation.

One rule is that I don't bring any furniture into the house unless I get rid of an equal amount. This also applies to tchotchkes (pronounced "chach-key," meaning a pleasing trifle). A tchotchke is, to Bob-O, anything that you keep around simply because it is pretty. Or in his words, a dust magnet. But, hey, look at the spelling. For me it's a genetic calling.

Animal Farm

One hard and fast rule is that we have no lactating animals. Bob-O already went through his lactating animal phase of back-to-the-land in the 70s. Other than that one animal rule, I have a free hand. That is why I have bees, am planning to acquire poultry soon, and have started a home vermicompost system—a worm bin.

This spring I called the local Agricultural Extension office and asked if anyone raised rabbits in our area. No one did commercially, but they gave me the name and number of the 4-H Rabbit Raising Advisor. I called him, and he promised to let people know that I was looking for rabbit manure. Within a week, we got a call. A man whose children raised rabbits was moving. He wanted all the manure under the cages removed. We got a pickup truck load in about an hour.

Ever since Bob-O raised rabbits, he has preferred rabbit manure for the garden. Next is horse manure and only as a last resort will we use cow manure. Too many weed seeds.

Tub-O-Worms

As we were loading the manure, I could see a large population of red worms (*Eisenia foetida* and *Lumbricus*

rubellus) in it. Although I knew they were the right kind of worms for composting, I didn't learn the official names until I read up on the subject. When we got home, I filled our old bathtub with some of the manure, and the rest went to the garden. After we remodeled our bathroom, we moved the old bathtub out under the large apple tree. I thought I would bury it to ground level and use it for a pond. This spur-of-the-moment use turned out to be much better.

I covered the tub with a wooden pallet to keep our dog and the wild varmints out. I was using a two gallon bucket to collect food scraps in my kitchen for composting. I use a Sun Frost solar Scrap Eater for most of my household composting (see *Home & Heart*, HP63). Now I alternate between the Scrap Eater and the bathtub. By burying the food scraps and sprinkling water occasionally, I was able to see a healthy population of worms grow in the tub throughout the summer. I used a pitchfork to aerate the manure. I added a seven gallon bucket of sawdust once and worked it in.

The process was working really well, but winter was approaching. Bob-O said he would bury the tub so I could use the ground as insulation. But I was afraid the metal tub would wick the freezing temperatures and kill the worm population. It's necessary to keep the worms' environment at temperatures between 50 and 84°F (10–29°C).

I borrowed Mary Appelhof's book, *Worms Eat My Garbage*, from my local library. The book has calculations for a worm bin 2 feet by 2 feet by 8 inches (60 x 60 x 20 cm). I had a wooden drawer left over from the bathroom remodel. Its dimensions were 30 by 18 by 9 inches (75 x 45 x 23 cm). Another common size for the home worm bin is 1 by 2 by 3 feet (30 x 60 x 90 cm), which will accommodate the food waste of four to six people. My drawer size would work for one to two people. Complete assembly instructions for the two bins are in the book.

Bin Preparation

I drilled about forty 1/2 inch (13 mm) holes in the drawer bottom for drainage and aeration. I set the bin on bricks in my basement, so air could flow around it. The next step was to choose a type of bedding. I used shredded newspapers because I had them. For my bin, I needed 4 to 6 pounds (2–3 kg) of dry bedding. The 1 by 2 by 3 foot bin (1–2–3 bin) would have used 9 to 14 pounds (4–6 kg) of dry bedding. It took a while to shred enough paper. Other options for bin bedding are shredded cardboard, chopped straw and other dead plants, seaweed, sawdust, peat moss, aged manure, and leaf mold.

A worm's body is 75 to 90 percent water. So the bedding must also be that wet. The formula is three pounds of water to one pound of bedding. My bin has 6 pounds of dry bedding so I had to add 18 pounds of water. One gallon of water weighs 8 pounds (3.6 kg). After adding the water, I mixed two handfuls of sand and soil into the bedding to aid in the worms' digestive process. They have something called a crop that acts like a gizzard in a chicken, so they need grit in their diet. The bin is covered with thick layers of newspaper to keep the moisture in and keep it dark for the worms.

Waste vs Worms

The ratio of worms to daily food waste is 2 pounds of worms to 1 pound of waste. If you collect your food waste in a 16 ounce tub, it will be easy to calculate one week's weight of waste. My bin has 1 pound of worms in it. They will consume my food waste of 1/2 pound per day. The 1–2–3 bin would house 2 pounds of worms that would consume 1 pound per day of food waste.

Fun of Sorts

Now for the fun part—sorting the worms from the manure. The swell method is to make small cone-shaped piles of the manure on some flat surface. I used a 4 by 4 foot piece of plywood. As the worms recede into the core of the pile, just keep removing the outer layer of composted material they push to the top. The really great thing about this method is that you end up with a pile of almost pure worms. This helps a lot if you are going to weigh them. Since my worms were all different ages and sizes, they are called pit-run worms and average about 2,000 worms to a pound.

Waste Trail

It will take two to three months for the worms to process each batch of buried waste. There is a pattern to use in burying the waste. Start at one corner and bury your waste under 1 or 2 inches of bedding. The next time you bury waste, put it in front of the last place. Keep doing this until you get to the other side of the bin. Then move over and use the space directly beside your last site.

Now continue back across the bin. The pattern will look like a long wavy line from side to side across the bin area. When your waste has been buried throughout the bin, start the pattern again. By the time you have returned to the first site, the worms will have broken down the food waste enough that you can bury the new waste there.

The idea is that by always having the waste buried next to the last site, the worms can just progress along the waste trail without having to go look for it. Some worms will stay at each burying site and continue to work on the composting process.

Worms will eat fruit and vegetable scraps, egg shells, tea leaves, coffee grounds and filters, breads and grains, cottage and cream cheese. Actually they will eat too many foods to name. Basically stay away from oily foods, meats (will smell bad and attract flies), and any non-biodegradable objects.

Worm Continuum

After two and a half months, the original bedding will look like brown crumbly earth. Harvest the compost by moving the old bedding to one side of the bin. Add new bedding, bury new waste. The worms will move into the new bedding over time. You can remove the finished compost (castings) to use as a soil conditioner for any and all plants in the house and garden. If you want to get all the castings at once, use the pile and sort method described above.

I highly recommend the book, *Worms Eat My Garbage*. It takes you step by step through the whole experience. There is even a worksheet if you want to keep records. Mary Appelhof's Web site is also a must.

Access

Kathleen Jarschke-Schultze is enjoying her Dad's home-cured olives at her home in Northernmost California, c/o *Home Power* magazine, PO Box 520, Ashland, OR 97520
kathleen.jarschke-schultze@homepower.com

Worms Eat My Garbage, by Mary Appelhof, 1997, ISBN No. 942256-10-7 • Flower Press, 10332 Shaver Rd., Kalamazoo, MI 49024 • 616-327-0108
Fax: 616-327-7009 • nancy@wormwoman.com
www.wormwoman.com

Victoria Compost Education Centre, 1923 Fernwood Rd., Victoria, B.C. V8T 2Y6 Canada
Compost Hotline: 250-386-9676 • Fax: 250-386-9678
compost@ampsc.com • These folks are good source of printed reference material, and have quite a good program promoting vermicomposting, as well as worm bin kits for sale.

Worm Digest, PO Box 544, Eugene, OR 97440
Phone/Fax: 541-485-0456 • mail@wormdigest.org
www.wormdigest.org • A quarterly newspaper on worms and worm composting. Subscription (4 issues) US\$12 per year in the U.S.

Scrap Eater, Sun Frost, PO Box 1101, Arcata, CA 95518 • 707-822-9095 Fax: 707-822-6213
info@sunfrost.com • www.sunfrost.com



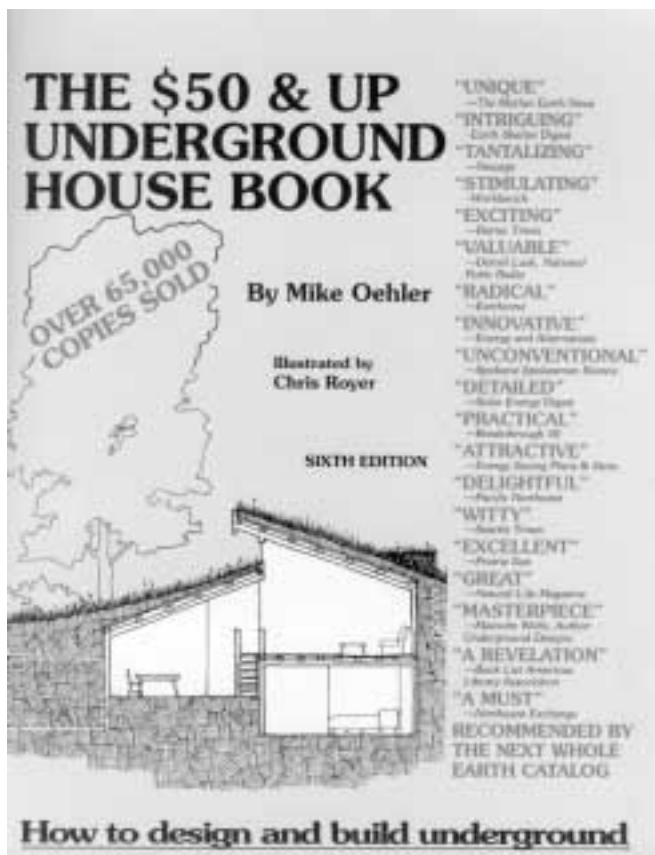

The \$50 & Up Underground House Book

By Mike Oehler

Reviewed by Don Kulha

©1999 Don Kulha

We've all probably pondered living in an underground home at one time or another. They're reputed to be cooler in summer, warmer in winter, and fairly expensive to do right. Mike Oehler would agree with the first two statements, and laugh at the last one.

His current underground home cost US\$1.35 per square foot to build, compared to a national average of over US\$30 per square foot. He accomplished this feat by thinking "outside the box," using recycled materials, and developing an innovative building system.

Mike is very opinionated and gets in your face right away. He points out his personal likes (hippies, back-to-the-landers, environmentalists, backyard tinkerers) and his dislikes (businessmen, the medical establishment, architecture, agribusiness, television, and automobiles).

He's very upfront in saying, "If you find the majority of these likes and dislikes offensive, this book is not for you." His approach to underground construction is different, somewhat radical, and quite refreshing.

Mike points out that the book is the result of seven years of trial and error, beginning with the construction of his first underground home in 1971. His home is a "growing, living thing which has light and air and views"—not a concrete bomb shelter or a cave.

Most underground homes are enveloped in a thick EDPM rubber sheath for waterproofing. Mike utilizes thin layers of polyethylene sheeting, carefully laid out in his "PSP (post-shoring-polyethylene) system." This system, in conjunction with his design principals to eliminate problems with drainage and lateral earth thrust, form the heart of his approach to underground construction.

The book is well written and entertaining. It includes photographs, drawings, and his useful "rule-of-thumb engineering tables" dealing with beam, girder, and post sizing and spans. I think Mike is right when he says that anyone with minimal skills, this book, and the desire can build this type of home successfully. He presents the material in a very understandable manner that even construction novices can understand.

There are sections on wiring, excavation, building codes, and recycled and cheap materials. While covering the engineering details nicely, Mike includes a lot of information on laying out the home in relation to the surrounding land, vegetation, and solar access. He suggests many options such as built-in greenhouses, sunscoops, clerestories, gables, foyers, and multi-level floor plans. Even if you aren't comfortable with Mike's approach to the physical construction details, you'll find plenty of useful information in his book.

I'm not personally anticipating building an underground home anytime soon, as much as I'd like to. But I can see many other useful applications for the information. It could be quite handy for root cellars, food storage bunkers, shelters, or storage units. The basic principles remain the same. This book has been a good source of inspiration for me and I think you'll find it enlightening and useful as well.

Access

The \$50 & Up Underground House Book, Mike Oehler, Sixth Edition, ISBN 0-442-27311-8. US\$16.95 postpaid in the U.S. from Mole Publishing Co., Rt. 4, Box 618, Dept. 35, Bonners Ferry, ID 83805 • 800-328-8790 or 208-267-7349

Reviewer: Don Kulha, PO Box 7518, Santa Rosa, CA, 95407 • don.kulha@homepower.com



AC/DC Inverters, Solar Electric Modules
 Batteries, Charge Controllers
 DC/Propane Refrig, Track Rack
 Water Pumps, DC Lights, DC Appliances

1-888-SOLARNOW
Toll Free

HORIZON INDUSTRIES

*We Sell The Best
& Service The Rest*

Mention This Ad & Receive A Free 100 Page Catalog
 2120 W Mission Rd (# L), Escondido, CA 92029
(760) 480-0403
www.horizonsolar.com

Solar Pathfinder

The Best Tool For Solar Site Analysis

- * Easy to Use
- * Fast & Accurate
- * Diagrams from 0-66° N & 0-49° S
- * Pathfinder with metal case & tripod
\$210, Handheld \$135 (+ shipping)

65500 Solar Rd., Dept. HP
 Montrose, CO 81401
 Phone & Fax 970-249-2093

DISCOUNT HOME POWER PRODUCTS

Components and complete systems by Trace,
 Siemens, Southwest Windpower, SunWize, Concorde,
 Zomeworks, and other quality manufacturers.
 Visit us on the Web to start saving \$\$\$!

MHS-SOLAR.com

MHS Solar • PO Box 31304 • Alexandria, VA 22310

Phoenix Composting Toilet System

**Odorless • Waterless • Large Capacity
 Low Energy Requirements • Owner-Friendly**

| | |
|---|--|
| <p>Advanced Composting Systems 195 Meadows RD Whitefish, MT 59937 Voice: 406-862-3854 Fax: 406-862-3855 phoenix@compostingtoilet.com www.compostingtoilet.com</p> | <p>Sunergy Systems, LTD Box 70, Cremona AB TOM ORO Voice/fax: 403-637-3973 sunergy@telusplanet.net In British Columbia: Voice: 250-751-0053 Fax: 250-751-0063</p> |
|---|--|

AMERICAN TOUR DE SOL

MAY 12-19, 2000
NEW YORK CITY
 to
WASHINGTON, DC

12th Annual EV, HEV and Fuel Cell Championship

NORTHEAST SUSTAINABLE ENERGY ASSOCIATION
 50 MILES STREET • GREENFIELD, MA 01301 • (413) 774-6051 FAX 6053
 EMAIL: nesea@nesea.org WEB ADDRESS: <http://www.nesea.org>

Please send me more information on:

| | |
|---------------------------------------|---|
| <input type="checkbox"/> Entering | <input type="checkbox"/> Attending |
| <input type="checkbox"/> Volunteering | <input type="checkbox"/> Exhibiting or Sponsoring |

Name _____
 Company name _____
 Address _____
 City, State, Zip _____
 Phone _____ Fax _____



Independent Energy Systems

CA Lic. #661052
Our 16th Year Offgrid!

*We will meet or beat any other company's prices.
 We provide excellent service and technical support.*

Residential Power • Water Systems • Communications
 Wind • PV • Hydro • Custom Design • Installation • Mail Order

All Major Brands

SIEMENS  SunFrost

California Rebates!
(559) 877-7080

e-mail: ofln@aol.com
<http://www.psnw.com/~ofln>
located in the central Sierra, near Yosemite

OFFLINE
 P.O. Box 231
 North Fork, CA
 93643

CATALOG AVAILABLE

Harris Hydroelectric

Hydro-Power for Home Use

Works with heads as low as 10 feet • Price starts at \$750

New Features:

17 bucket reshaped Pelton wheel

Powder coated castings

More efficient stator in high output models

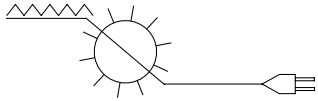

632 Swanton Road
Davenport, CA 95017
831-425-7652

"The best Alternator-based MicroHydro generator I've ever seen."

Bob-O Schultze, Hydroelectric Editor, Home Power Magazine

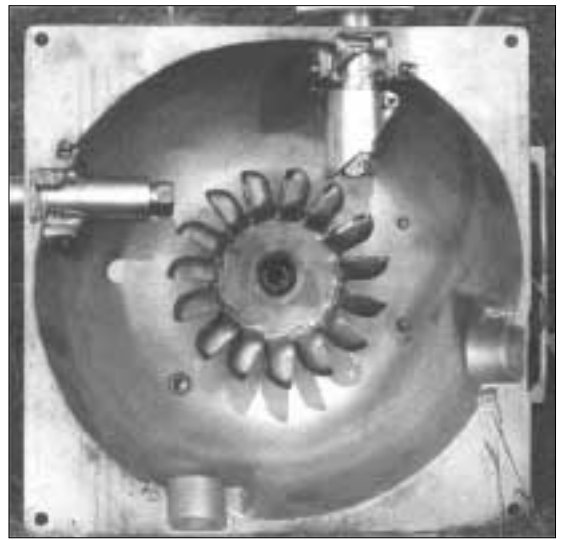

PeaPac Portable Power!

AC and DC power whenever and wherever you need it.

Versatile "power-in-a-box" can be used for emergency, backup, or full time power in your home, boat, camp, RV, car, construction site...

Take it with you! Safe and easy to use with optional built-in AC or solar charge inputs,

PeaPacs are ready to work for you!

200 or 1300 watts of power.

Prices start at \$299 (less battery).

~ Spectacle Technology ~

"The company with vision"



P.O.Box 114, E. Calais, VT 05650 • 802-456-7097
www.spectacletech.com/ email: info@spectacletech.com

BackHome Magazine

b/w

3.0 wide

5.8 high

MINI 12/8 **MINI 12/8**



Low Cost. High Performance 8 amp PWM Charge Controllers.

Ideal for RV's, marine, commercial applications.

For all battery types & chemistries.

Five year warranty

Available world wide

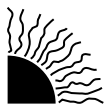

B. Z. Products, Inc.

7614 Marion Ct., St. Louis, MO 63143, USA

tel: 314-644-2490, fax: 314-644-6121

email: bzp@inlink.com

HAPPENINGS

AFRICA

Kagera Community Development Trust (KADET). We are looking for a donation of US\$12,655 for fabrication and distribution of solar cookers under a pilot scheme aimed at tackling energy crisis in the rural areas of the Kagera Region. Also we are looking for representative in the US for the Solar Projects. Contact Mr. C. Fidelis Mutakyahwa, Executive Director, PO Box 1005, Bukoba, Tanzania. mutta@twiga.com

CANADA

Alberta Sustainable House: Open 3rd & 4th Saturdays (except holiday weekends), 1–4 PM, free. Cold-climate features/products re: health, environment, conservation, AE, recycling, low energy, self-sufficiency, & appropriate technology. Autonomous & Sustainable Housing, 9211 Scurfield Dr NW, Calgary, Alberta T3L 1V9, Canada 403-239-1882 • Fax: 403-547-2671 jdo@acs.ucalgary.ca www.ucalgary.ca/~jdo/ecotecture.htm

The Institute for Bioregional Studies demonstrates & teaches ecologically-oriented, scientific, social & technological achievements. IBS, 449 University Ave., Charlottetown, Prince Edward Island C1A 8K3 Canada 902-892-9578

Vancouver Electric Vehicle Association, call for meetings: 1402 Charlotte Rd., North Vancouver, BC V7J 1H2 Canada 604-987-6188 • Fax: 604-253-0644 rcameron@statpower.com

CHINA

Apr 18–21, 2000, Int'l Exhibition on New Energy, RE, and Energy Saving 2000, Shanghai. Kammy Shum, Project Manager, Coastal Int'l Exhibition Co. 852 2827 6766 • Fax: 852 2827 6870 www.coastal.com.hk general@coastal.com.hk

CUBA

April 24–28, 2000: Cubasolar 2000—Learn about how Cuba is meeting its energy needs with renewable energy. To be held in the Sierra Maestros of Cuba. Topics include: Rural electrification, bioclimatic architecture, ecotourism, culture and energy conscience, & research & production of

RE equipment. Contact: Emir Madruga Fax: 24 1732 or 24 2699 sol@colombus.cu

NICARAGUA

Jan 3–14, 2000 (repeated August 2000): SPECIAL SHORT COURSE on SOLAR ENERGY IN NICARAGUA An opportunity to offer your hands, heart, and a unique gift: Electricity! A great hands-on introduction to PV for developing countries. Combination of lectures, field experience, & tourism. Taught in English by Dr. Richard Komp of Sunwatt & Maine Solar Energy Society and Professor Susan Kinne of FENIX & the Nicaraguan Engineering University (see Photovoltaics in Nicaragua, *HP61*). Cost: \$750 (all expenses) + airfare. Contact: Barbara Atkinson • 215-942-0184 lightstream@igc.org

NATIONAL U.S.

American Hydrogen Association nat'l headquarters: 1739 W. 7th Ave., Mesa, AZ 85202-1906 • 602-827-7915 Fax: 602-967-6601 • aha@getnet.com www.clean-air.org

American Wind Energy Association. Info about US wind energy industry, membership, small turbine use, & more: www.igc.org/awea

Reports on State Financial & Regulatory Incentives for RE. North Carolina Solar Center, Box 7401 NCSU, Raleigh, NC 27695 • 919-515-3480 Fax: 919-515-5778 www.ncsc.ncsu.edu/dsire.htm

Energy Efficiency & Renewable Energy Clearinghouse (EREC): Insulation Basics (FS142), New Earth-Sheltered Houses (FS120), PV: Basic Design Principles & Components (FS231), Cooling Your Home Naturally (FS186), Automatic & Programmable Thermostats (FS215), & Small Wind Energy Systems for the Homeowner (FS135). EREC, PO Box 3048, Merrifield, VA 22116 • 800-363-3732 TTY: 800-273-2957 energyinfo@delphi.com www.eren.doe.gov

Energy Efficiency & Renewable Energy Network (EREN), links to gov't & private internet sites & offers "Ask an Energy

Expert" online questions to specialists: www.eren.doe.gov • 800-363-3732

Green Power Web site: Discusses green power including deregulation, "green" electricity choices, technology, marketing, standards, environmental claims, & varying national & state policies. Global Environmental Options (GEO), & CREST: www.green-power.com

Kids to the Country: an ongoing program to show at-risk urban children a country alternative. PLENTY, 51 The Farm, Summertown, TN 38483 615-964-4391 • ktc@thefarm.org

Tesla Engine Builders Association (TEBA): info & networking. Send SASE to TEBA, 5464 N Port Washington Rd Suite 293, Milwaukee, WI 53217 teba@execpc.com www.execpc.com/~teba

Sandia's web site, "Stand-Alone Photovoltaic Systems: A Handbook of Recommended Design Practices," "Working Safely with PV," & balance-of-system technical briefs, info on battery & inverter testing: www.sandia.gov/pv

Solar Energy & Systems, Internet college course. Fundamentals of small RE. Weekly assignments reviewing texts, videos, WWW pages, chat room, & email Q&A. Mojave Community College. \$100 plus \$10 registration. 800-678-3992

lizcaw@et.mohave.cc.az.us chacol@hal.mccnic.mohave.az.us

Federal Trade Commission free pamphlets: Buying An Energy-Smart Appliance, EnergyGuide to Major Home Appliances, & EnergyGuide to Home Heating & Cooling. EnergyGuide, FTC, Rm 130, 6th St & Pennsylvania Ave NW, Washington, DC 20580 202-326-2222 • TTY: 202-9326-2502 www.ftc.gov

The Interstate Renewable Energy Council, SEIA, & Sandia: handbook for government procurement officials & others on the specs & purchase of RE. US\$15 ppd (make checks to ASES), Interstate RE Council Distr Center, c/o ASES, 2400 Central Ave Ste G-1, Boulder, CO 80301

Solar curriculum for upper elementary & intermediate grades—Free! Six week science curriculum or individual sessions. Over 30 classroom presentations & demos using free or low

cost materials. Student tested, teacher approved. Florida Solar Energy Center, Susan Schleith • 407-638-1017
www.fsec.ucf.edu

ALABAMA

The Self-Reliance Institute of NE Alabama seeks others interested in RE, earth-sheltered construction, & other self-reliant topics. SINA, 6585 Co Rd 22, Centre, AL 35960
cevans9@tds.com

ARIZONA

Tax credits for solar in AZ. A technician certified by the AZ Department of Commerce must be on the job site. ARI SEIA, 602-258-3422

Dec. 7–9, '99: Kyocera Solar, Inc. Basic Solar Seminar: Overview on solar modules, controllers, batteries, inverters, & system sizing. Contact: Kyocera Solar, Inc. Training Dept. 800-544-6466 x7148 • Fax: 480-443-4562 • seminars@kyocerasolar.com
www.kyocerasolar.com

Jan 25–27: Kyocera Solar, Inc. Advanced Solar Seminar: Technical training provided by professionals from well-known manufacturers & personalized training by our senior engineers. Contact: Kyocera Solar, Inc. Training Dept. • 800-544-6466 x7148
Fax: 480-443-4562
seminars@kyocerasolar.com
www.kyocerasolar.com

CALIFORNIA

Campus Center for Appropriate Technology, Humboldt State University, Arcata. Ongoing workshops & presentations on alternative, renewable, & sustainable living. CCAT, HSU, Arcata, CA 95521 • 707-826-3551
ccat@axe.humboldt.edu
www.humboldt.edu/~ccat

NCSEA Sacramento Solar Speaker Series, SMUD Customer Service Center, second Monday of every month, 7–9 pm. 916-44-SOLAR

Energy Efficiency Building Standards for CA. Download or hard copy. CA Energy Commission, 800-772-3300
www.energy.ca.gov/title24
Questions about Title @4 to:
CALLCNTR@energy.state.ca.gov

COLORADO

Solar Energy International, hands-on workshops. One & two week sessions: PV Design & Installation, Advanced PV, Wind Power, Microhydro, Solar

Cooking, Environmental Building Technologies, Solar Home Design, & Straw Bale Construction. Experienced instructors & industry reps. For owner-builders, industry technicians, business owners, career seekers, & international development workers. \$500/week. SEI, PO Box 715, Carbondale, CO 81623
970-963-8855 • Fax: 970-963-8866
sei@solarenergy.org
www.solarenergy.org

National Wind Technology Center, Golden, CO. Assisting wind turbine designers & manufacturers with development & fine tuning.
303-384-6900 • Fax: 303-384-6901

CONNECTICUT

March 15–18, 2000: Building Energy 2000: Buildings, People and the Planet, 16th Annual QBC Conference, Yale University. A Conference on Renewable Technologies and sustainable design strategies focusing in solutions to the global climate challenge which promotes economic growth. Contact: NESEA, 50 Miles St., Greenfield, MA 01301
413-774-6051 • Fax: 413-774-6053
nhazard@nesea.org • www.nesea.org

FLORIDA

Feb 25–26, April 28–29, & July 14–15, 2000. FLASEIA workshop: Solar Electric Home for the South. Learn to design, size, & install a solar electric system in your future home. Integration of the Energy Star Home with solar modules, generator &/or utility backup or interconnection. Learn what makes a home comfortable in hot, humid climates. \$125 for 2 days. Energy Conservation Services, 6120 SW 13 St., Gainesville, FL 32608 • 352-377-8866
Fax: 352-338-0056
tom@ecs-solar.com

IOWA

Iowa Renewable Energy Association (IREA) meets 2nd Sat every month at 9 AM, Prariewood, Cedar Rapids. All welcome. Call for schedule change. I-Renew, PO Box 466, North Liberty, Iowa 52317 • 319-338-3200
irenew@irenew.org • www.irenew.org

KENTUCKY

Appalachia-Science in the Public Interest. Projects & demos in gardening, solar, sustainable forestry, & more. ASPI, 50 Lair St., Mt Vernon, KY 40456
606-256-0077 • aspi@kih.net
www.kih.net/aspi

MASSACHUSETTS

Greenfield Energy Park needs help preserving Greenfield's historic past, using today's energy & ideas, creating a sustainable future. Greenfield Energy Park, NESEA, 50 Miles St, Greenfield, MA 01301 • 413-774-6051
Fax: 413-774-6053

Oct–Dec, Sustainability Series, workshops & lectures. NESEA, 50 Miles St, Greenfield, MA 01301
413-774-6051 • Fax: 413-774-6053
nhazard@nesea.org • www.nesea.org

MICHIGAN

Tillers International, classes in draft animal power, small farming, blacksmithing, & woodworking. Tillers Int'l, 5239 S 24th St., Kalamazoo, MI 49002 • 616-344-3233
Fax: 616-344-3238 • TillersInt@aol.com
www.wmich.edu/tillers

MONTANA

Sage Mountain Center: Life Skills Workshops. One day classes: inexpensive earth-friendly home building, straw bale construction, log furniture, cordwood construction, natural & non-toxic interiors, & more. \$55 incl literature. SMC, 79 Sage Mountain Trail, Whitehall, MT • 406-494-9875

NEW MEXICO

Profit From The Sun workshops, Moriarty, NM. Renewable energy, energy conservation, sustainable living, & energy independence. James or Marek at PSF, Inc., 505-281-1300 days
James at 505-832-1575 eves & weekends • proffit@flash.net

NEW YORK

Oct. 15–19, 2000. Bioenergy 2000: Moving Technology into the Marketplace, the 9th biennial Bioenergy Conference. Call for papers, due 1/30/00. Contact: Christina Caffo at NRBF • 202-624-8464 • nrbbp@sso.org

NORTH CAROLINA

How To Get Your Solar-Powered Home: RE seminars through summer of 2000. Solar Village Institute, PO Box 14, Saxapahaw, NC 27340 • 336-376-9530
solarvil@netpath.net

OHIO

Solar/wind classes. Second Saturday each month, 10 AM to 2 PM. Tech info, system design, NEC compliance, efficient appliances. Register in advance. \$65, \$85 w spouse. In spring: hands-on straw bale post & beam

building. Solar Creations, 2189 SR 511 S., Perrysville, OH 44864
419-368-4252
www.bright.net/~solarcre

OREGON

Aprovecho Research Center, non-profit educational institute. Six week winter internship in Baja, Mexico: Study & research appropriate tech applications, learn Spanish, teach grade school, & work fruit orchards & gardens. Internship Coordinator, Aprovecho Research Center, 80574 Hazelton Rd., Cottage Grove, OR 97424
541-942-8198

SolWest Workshops: Retrofitting an Existing House for Energy Efficiency, taught by Anthony & Victoria Stoppiello, March 10–12, 2000. Annual Tour of Homes, hosted by EORenew, May 27, '00. Grid Intertie System Installation, a pre-fair workshop, taught by Richard Perez & Joe Schwartz, July 25–28, '00.

All workshops are in the vicinity of John Day, OR unless otherwise indicated. EORenew, PO Box 485, Canyon City, OR 97820 • 541-575-3633
solwest@eoni.com
www.eoni.com/~solwest

PENNSYLVANIA

August 21–23, 2000. Energy 2000 Energy Efficiency Workshop and Exposition: Pittsburgh, PA. Third annual national energy managers conference. Sponsored by the U.S. Department of Energy's Federal Energy Management Program. Co-sponsored by the U.S. Department of Defense and the U.S. General Services Administration. Contact: JoAnn Stirling, Florida Solar Energy Center, 1679 Clearlake Rd., Cocoa, FL 32922 • 800-395-8574
joann@fsec.ucf.edu

TEXAS

The El Paso Solar Energy Association bilingual web page. Info in Spanish on energy & energy saving. www.epsea.org
www.epsea.org.

GreenFire Institute: workshops & info on straw bale construction. GreenFire, 1509 Queen Anne Ave #606, Seattle, WA 98109 • 206-284-7470
Fax: 206-284-2816
wilbur@balewolf.com
www.balewolf.com

WISCONSIN

Midwest Renewable Energy Association (MREA) Workshops. See ad. Call for cost, locations, instructors, & further workshop descriptions. MREA Membership & participation: all welcome. Significant others half price. MREA, PO Box 249, Amherst, WI 54406 • 715-824-5166
Fax: 715-824-5399
mreainfo@wi-net.com

June 16–21, 2000: ASES, Solar2000—Solar Powers Life, Share the Energy conference. June 16–18, 2000: Midwest Renewable Energy Fair. Both events together in Madison, WI. Please see the ASES ad this issue.

"First-rate history, excellent writing, great storytelling..."
—Neville Williams, SELCO

FROM SPACE TO EARTH
The Story of Solar Electricity
John Perlin
From Space to Earth, by the author of the critically acclaimed *A Forest Journey* and co-author of the solar classic *A Golden Thread*, tracks the evolution of photovoltaics, the direct conversion of the sun's energy into electricity via solar cells.

From shaky 19th-century beginnings, to high-visibility success in the space program, to our increasing—and largely unrecognized—reliance on this subtle, silent energy source, John Perlin tells the true and amazing story of the technology and the truly amazing individuals who brought it to light. Details current advances, and examines applications in both the developed and developing world.

*From space to earth. From Mali to Manhattan.
From the mountains to the oceans. From the utility to your roof.
The history of photovoltaics.*

"An important contribution on the eve of the 'solar century.'"

Available for \$35 postpaid from **aatec publications**
ISBN 0-937948-14-4 240 pages 125+ illus. hardcover July 1999 \$32

To order, or for more information, contact **aatec publications**
800.995.1470 voice or 734.995.1470 • 734.995.1471 fax
aatecpub@mindspring.com
PO Box 7119 Ann Arbor MI 48107
Visa/MasterCard/American Express accepted.



Pony Enterprises

Offering affordable custom services to small businesses for single projects or recurring needs.

Design & Production Services Include:

- Mechanical Design
- CAD Drafting
- Machining & Prototyping
- DC Wiring
- Short Run Assembly & Production

Documentation & Marketing Services Include:

- Technical Writing
- Article Writing
- Web Site Design & Maintenance

We provide "a little extra horsepower" to take your project to completion.

Pony Enterprises
POB 1113, Felton, CA 95018
phone: 831-429-1994 • email: electro@cruzio.com
web site: www.cruzio.com/~ponyent/



the Wizard speaks...

Global Warming

Global warming is no longer just a possibility. It is quickly becoming a reality. The decade of the 1990s is the warmest in this century, possibly the warmest in the last millennium. There is even evidence to suggest that it may be the warmest in the last one hundred thousand years.

There are many signs of global warming now in evidence. Global mean temperature is up. Global mean sea levels are up. Antarctic ice sheets are breaking up and falling into the sea. Glaciers are melting and

receding. Seasons are changing. Global weather patterns are becoming more erratic. There is increased water vapor in the atmosphere. These are just some of the phenomena which suggest that global warming has already arrived.

The major source of global warming is the increased presence of greenhouse gases in the atmosphere. The largest contributor is carbon dioxide from the burning of fossil fuels. Others include methane, nitrous oxide, and water vapor. These gases prevent heat from escaping into the upper atmosphere and radiating into space. Thus, the temperature of the lower atmosphere is raised. This also causes the upper atmosphere to cool and shrink.

To roll back global warming, we must stop releasing carbon dioxide and other greenhouse gases into the atmosphere. We must severely cut down on the burning of fossil fuels., and prevent the release of greenhouse gases of all types. Eventually, the energy and fuel economy of the entire planet needs to be changed. Solar and wind energy, along with electric vehicles, must become the choice for the immediate future. This choice needs to be made soon. Potential positive feedback in the Earth's atmospheric and weather systems could greatly accelerate the onset of severe global warming effects. Act now!

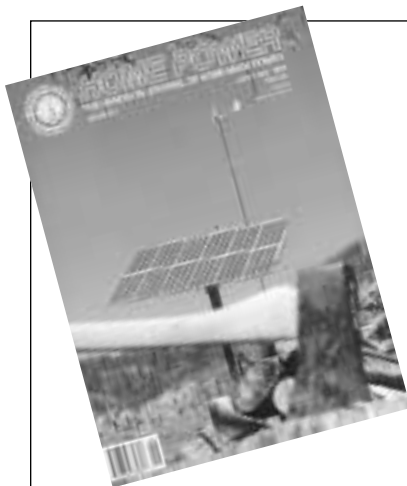

Back Issues of Home Power !

Check out our Web site www.homepower.com ... It contains an index of all articles back to issue #1.

You can buy back issues individually:

- \$3.25 each for 17 through 20
- \$4.75 each for 21 through 45 (except for 25, 35, 36, 38, 40, 41)
- \$5.75 each for 46 through 72 (except for 59-61, 63-65, 67)

- OR -

Deal #1: All available back issues for \$100

Deal #2: 6 or more issues (of 21 through 73) for \$4.00 each (*sent bound printed matter*).
for U.S. ZIP codes only, see page 81 for international back issues.

Check with your local library—through interlibrary loan you can get back issues. The Jackson County Library in Oregon and the Alfred Mann Library at Cornell University have all issues.

Or, get the CD-ROMs—*Solar2 (HP1-HP42)*, *Solar3 (HP43-HP60)* and *Solar4 (HP61-HP70)*.

Home Power, PO Box 520, Ashland, OR 97520 • 800-707-6585 • 541-512-0201



Good Info!
Good Deal!
in USA
800-707-6585

ELECTRIC CAR COMPONENTS & KITS

- *Reliable, Affordable Components
- *Large Library Of Adaptors
- *Most Experienced Tech Support
- *Design Assistance

Conversion Kits:

*Basic & Deluxe Universal Kits

Contain all drive system components. You add mounts, boxes, etc. to fit your model.

*Complete Custom Bolt-In Kits

Voltsrabbit for VW Rabbit, and *Voltsorsche* for Porsche 914. Completely prefabbed. No design or welding necessary. Kits include everything except donor car & batteries.

For Catalog, Send \$6.00 To:

ELECTRO AUTOMOTIVE
POB 1113-HP
FELTON, CA 95018



(Outside the U.S. & Canada, add \$5.00)

www.electroauto.com

THE ORIGINAL MULTI-ARRAY White LED Flashlight

The most practical flashlight ever made!



\$34⁹⁵

Price Includes
 Batteries & Shipping
 Made in U.S.A.

Lasts Over 50 Hours
 on 3 'AA' Alkaline
 Batteries

Its
 Waterproof!

Unbreakable LED
 Bulbs Last
 Thousands of Hours



Call 1-800-522-8863
 To Order or for a FREE Catalog
 Visit Our Website at c crane.com

Lake Superior Renewable Energy

A.D. & P.C. Jasmin, Proprietors - A. Durst, Associate

- Wind Generators • Towers • Batteries
- Charge Controllers • Inverters • Backup Generators
- Battery Chargers • Site Evaluation
- Complete Systems Troubleshooting and Repair Service
- Surplus Military & Computer Grade Electronics

We also do: Custom Computer Building / Upgrading / Networking
 Custom and Classic Motorcycle Electrical System Rewiring

819 Maple Grove Rd., Duluth, MN 55811
 (218) 722-6749

e-mail: slakjaw@aol.com • web: <http://members.tripod.com/~LSRE>

STEAM POWER

www.sensiblesteam.com

ENGINES BOILERS GENSETS

Books, vids, info: call 417-336-2869

Do You Need Batteries?...

RAE Storage Battery Company

Since 1943... Quality & Service

Surrette Solar 1, 400 Series, Type CH 375 - L16

- 33.3% More Life Cycles
- Greater Reserve Capacity
- Expected Life of 10 Years
- Warranty 2 Years Unconditional
 3 Years Prorated
- Available Wet & Dry Charged
- Engineered under careful guidelines
 by Dave Surrette - Family owned
 business Est. 1935



If you need Competitive Pricing
 & Prompt Delivery call: 860-828-6007



Fax 860-828-4540
 51 Deming Rd., POB 8005,
 Berlin, CT 06037

Northwest Energy Storage is now wholesaling all Surrette
 Batteries west of the Mississippi. Call 800-718-8816

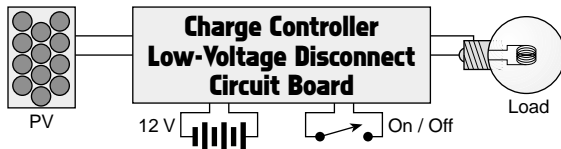

As featured in *Home Power* #60 and #63

Blank PC board \$20 • 8-Amp kit \$45 • 8-Amp assembled and tested \$60

Send check or money order to:

Eklectix, Inc., 2910 Carnegie Dr., Boulder, CO 80303
www.eklectix.com/solar • sales@eklectix.com

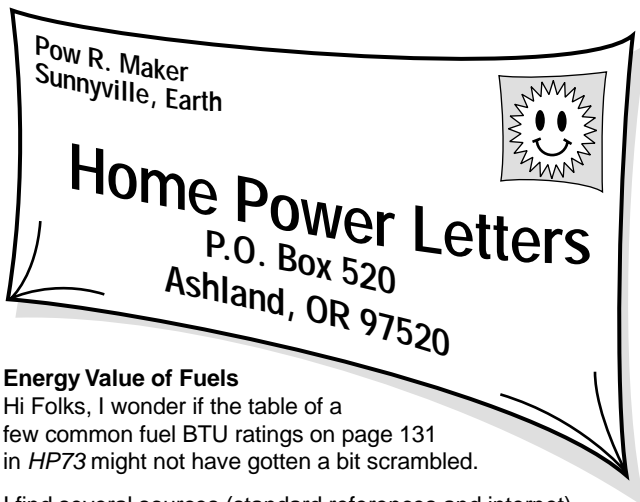

Energy Value of Fuels

Hi Folks, I wonder if the table of a few common fuel BTU ratings on page 131 in *HP73* might not have gotten a bit scrambled.

I find several sources (standard references and internet) giving 91,500 BTU per gallon for propane; also several sources giving 125,000 BTU per gallon for gasoline; methanol is 67,750; while ethanol is 67,000 in one place, and 86,700 in another. So I think there is some confusion here, but nowhere near the 142,000 BTU/gallon you mention. Fuel oil runs from 135,000 to nearly 150,000 BTU per gallon depending on the source and grade. Diesel, fuel oil, and JP4 are all very similar and are quoted in the range above (i.e., about 140,000 to 145,000 BTU per gallon).

This corresponds to what I have always heard and assumed to be common knowledge—alcohol and propane give poorer mileage per gallon than gasoline, while diesel gives better mileage (of course diesel engines are also more efficient than gasoline engines, other things being equal).

I think that in your table, the value you give for diesel was probably meant for methanol (though it seems a little low from what I found); the value for propane was for meant for gasoline (also somewhat low); the value for gasoline seems to be the value for propane; and the value for methanol should be for diesel. Please check it out—a lot of your readers depend on you for accurate information. Regards to the crew—keep up the good work, 73, Jonny Klein K7JK • jonnyk26@alum.mit.edu

Dear Jonny, you are correct—the BTU ratings for various fuels printed in HP73 on page 131 were incorrect. These are the correct ratings:

*Gasoline = 115,000 BTU / gallon
Propane = 91,500 BTU / gallon
Diesel = 142,000 BTU / gallon
Methanol = 63,000 BTU / gallon*

New Home for the Battery Bunny

I'm happy to report the battery bunny (see *HP73*, page 94) will have a new home in Iowa with us after December! My husband Chad and I have been in contact with the Oregon folks and we are through with most of the steps for us to purchase it and haul it to Iowa. We'd been planning a trip to Oregon to visit Chad's brother for nearly a year and thought it uncanny that such a deal might coincide with our trip. Plus, we already owned the book *Convert It* by Brown and Prange who oversaw the conversion of the car. This is better than a lucky rabbit's foot keychain!

We have been members of the Iowa Renewable Energy Association for some time and will enjoy promoting renewables

with our own car. This car is a dream come true for me. I've wanted an electric car for at least ten years. I figure using the car in everyday situations is a powerful role model, and since I work in conservation education and communications I am a bit more visible in the local community than most folks. So, the article in the magazine that led us to the car in the first place is exactly what I want to pass around as I travel and "show off" my bunny.

Chad is a carpenter specializing in energy-efficient construction and is often in situations where he can talk about renewables. *Home Power* has been an important resource for both of us. This car helps us in our ten year plan to use renewable, non-polluting energy sources on our acreage. I figure it's just like someone buying a bass boat for recreation—only I can get groceries in mine, and use it every day, not just on the weekends. In our area, people will spend more on antique cars or golf carts and have something that sits unused most of the time. Thanks for the article that "sparked" our new adventure! Jean Eells, 2550 Stagecoach Rd., Webster City, IA 50595-7375 515-832-1771

Hurricane Floyd

Dear Trace Engineering and the *Home Power* crew, We were lucky—compared to the rest of North Carolina. We live in Apex, NC, a good distance away from all the flooding that is still occurring. When Hurricane Floyd came pounding through last week, we knew we were going to lose power. It was just a question of when and for how long. We did lose power at about 3 AM the morning Floyd came through. My wife and I were ready for it, though.

Several months ago we purchased a Trace SW4024 as part of the solar electric system for our new house addition (we planned to run the new addition entirely off solar power). The addition has yet to be built, but that hasn't stopped us from setting up an experimental system. Our system sits on a 4 by 8 sheet of plywood with six AstroPower 120s. Imagine a right triangle, with the hypotenuse holding the PV panels and the vertical leg housing the inverter, disconnects, and control circuitry. It's all mobile so I can shove it into the garage during inclement weather.

Before Floyd hit, I had a plan in place on how to wire the SW4024 into our house breaker panel (I did make sure I was not backfeeding the grid). So when the 3 AM power outage did occur, we were up and running in 20 minutes with *silent* AC power. It was a great feeling knowing we were supplying our entire house (minus the 220 V appliances) with power. I had our house down to 5 amps at 24 VDC draw. Not bad for our first "solo" venture. We'll do better on that new addition once it gets built.

I just wanted to say a big "Thank You" to the *Home Power* gang and Trace Engineering. You provided the motivation and the technology for this all to happen. Walt & Judy Heilsnis, Apex, North Carolina

Grounding

We just got a call from a guy who took a lightning hit in his ungrounded system. He has a Windseeker and two DR inverters. The Windseeker took the hit and needs some repair (it's not totaled, though). The strike kicked the inverters off and shut the system down. Afterwards he went out and turned on the inverters, and everything was fine!

I suspect he wouldn't have gotten off so easy if he had a grounded system. There is more to the story on grounding than what the code says. Lightning and safety issues prompt the grounding question to rear its head once again for me. What do you think? Kelly Larson, Technician, Alternative Energy Engineering, 1155 Redway Dr., Box 339, Redway, CA 95560 800-777-6609 x126 • Fax: 800-777-6648 kelly@alt-energy.com

Hello Kelly, The topic of lightning and grounding is a hot item (pun intended). Lightning is so fickle that it is impossible to develop any effective program for protecting against it. Each lightning strike is unique. We've taken many hits here. Sometimes nothing is damaged; other times the damage is widespread and severe.

In the situation you mention, I'm surprised to hear that there was no damage to the inverters, which are often the first thing to go.

Grounding as done by the NEC in the USA is largely a waste of copper. In my opinion (which is contrary to that of the NEC), the grounding of current handling conductors invites lightning damage into system electronics. I prefer the European standard of grounding the equipment cases and exposed outside metal (towers, PV frames, etc.) but not grounding the AC neutral.

Incidentally, I've worked in commercial television, pinging electrons for CBS. We had a 100 KW transmitter on top of a 7,500 foot mountain, and we never grounded any current-handling conductor (commercial systems such as this are exempt from the "household" grounding rules of the NEC). With this setup, we took as many as a dozen hits daily during lightning season. We had damage without any clear reason as to why the lightning took one path instead of another. We had everything mega-grounded, and we still sustained routine lightning damage.

I can only wish that there was some technique that would protect RE systems from lightning damage. The fact is that no matter how many lightning arrestors, grounds, etc., a system has, it's still wide open to the unimaginable fury of lightning. When it comes to lightning protection, I think good karma may be a bigger factor than lightning protection devices or grounding in any form. Richard Perez

Ham Homebrewer

Hello Richard and Crew! I thought you might enjoy the enclosed propaganda from Public Service Co. of Colorado (PSCo). A couple of the items tout solar power and the others tout PSCo's Windsource program. It's nice to see a big utility at least paying lip service to renewable energy, an attitude that seems different from the west coast utilities I read about in *HP*.

With much fanfare, PSCo announced their wind farm up around the Colorado/Wyoming border. I was one of the early ones to sign up to receive wind power, and had to wait over a year before they were ready to deliver. They sell their wind power for a US\$2.50 per 100 KWH premium over their normal rates, and you must buy it in blocks of 100 KWH or else buy all your power from Windsorce. I buy one block a month, which is about one eighth of my electric bill.

Windsorce is fully subscribed with a waiting list. But, looking at the numbers, it's only a tiny fraction of the total power PSCo

generates and sells. It's a start, though, and I'm pleased to participate.

I've had a small photovoltaic system for several years. I currently have three 35 watt panels feeding two Trojan L-16 batteries for a capacity of about 350 amp-hours at 12 volts. I use a homebrew analog shunt controller that is hefty enough to work with several more panels. I use the power to run my ham station, capable of putting out 100 W on HF as well as 25 W on 2 meters. In fact, I have no other source of power for my ham station because solar power is so reliable and plentiful here in sunny Colorado! I also have a few 12 volt compact fluorescent lights in various parts of the house, and the small TV in my daughter's room runs from the system too. I need to put some additional loads on the system, as the controller starts shunting around 9 AM every sunny morning. I'm saving my pennies for a small sinewave inverter.

The story behind the shunt controller is interesting. My first homebrew controller was a simple relay on-off unit with hysteresis, turning off at 14.4 volts and back on at 14.1. The clack-clack of the relay, particularly in the afternoon, drove my wife crazy. She's an artist, and her studio was set up in the basement right next to the controller. When the relay clacking got to her, she'd reach up and turn the system off. So I put my head together with Rip NVOM, and we came up with a circuit that is basically a high power (30 amp) zener diode. It lets the system charge until the voltage reaches a set point of 14.4 volts. Then it absorbs (turns to heat) any current beyond that required to keep the batteries at 14.4 volts. A small, quiet fan comes on to keep the heat moving along. My wife was happy, I was happy, and the batteries were happy.

We've since moved, and now it's my turn to have my office next to the controller. The fan is a bare whisper and is not audible above the noise of the computer.

I enjoy *Home Power* immensely! Keep it coming! I know the big, store-bought systems are becoming more common, but there's still lots of us do-it-yourselfers out here who want to know the purpose of every wire, nut, and bolt.

Let me know if you'd like an article on my system or on the homebrew controller. I'd be happy to oblige. Yours, Dave Casler ke0og@msn.com

Hello Dave. Ham radio is a natural for solar power. As you've discovered, just a few modules are enough to make a ham station electrically independent. We'd love to have an article about your system and station, send it along! Richard Perez

Basic Training

I guess you could say that we are in guerrilla solar basic training. We have come to see the light (renewable that is). I did a tour of duty in Bosnia and saw how dependent on the U.S. Government they have become. And we've been watching our natural resources diminish as our population continues to grow (like there aren't enough people already). When I got home I spent some time in Colorado and heard "off-grid" for the first time.

Our basic training: after sit-ups, push-ups, and a daily 5 miler with our IPC's (individual personnel carriers, also known as feet), we power-read *Home Power* magazine, and anything else we can find.

Since we live in an apartment, we are restricted to what we can put up outside, and in this complex it's nothing, not even an American flag, and that really burns us. But we have found simple things to do. During the day we keep everything closed up and it stays cool, while our neighbors are running their AC full-bore. Then we changed all of our light bulbs and went with lower wattages, yet still enough to see by.

After an inventory of the power eaters around the house, we started making changes. We found a microwave with a dial, got solar switching nightlights, and have been going through the process of replacing all of our batteries with rechargeables. After some research and comparison shopping, we found Panasonics to be a great deal. While other types come fully charged, so is the price. With every package of these, you get a US\$2 refund, with a maximum of three packages for a \$6 refund.

We purchased a solar battery charger. It's easy—we put the batteries in the charger and set it on the porch in the morning before going to work. When we get home, the batteries are charged. Be sure to get extra sets of each size so you can keep them rotating.

For music, we found flashlight/radio combinations that charge by solar, a handcrank, or battery. We replaced all electric clocks with battery operated travel-style clocks. The great thing about these? No annoying wires. You can put 'em wherever you want to. We found a coffee pot that brews our coffee into a stainless carafe. Turn it on, let it brew. Five minutes later, turn it off—there's enough for two large cups for each of us.

So while our neighbors have power bills that spike as high as US\$190 per month, we have maintained a fairly constant \$12 to \$15 bill. This keeps the money in our pocket, rather than in the pockets of the big power companies. Since we have extra bucks, please find the enclosed check for a pair of black Guerrilla Solar T-shirts.

I cannot wait to see what we can do when we build our Monolithic Dome home in Colorado and we are off-grid forever. Keep up the good work, and watch your sixes from those Government types. Pat 'n' Terri Anderson, Taylorsville, UT

Hello Pat 'n' Terri. That's the spirit! Making even small changes in how we use power can deliver big savings on the electric bill. These efficiency changes make it easier and cheaper to eventually go solar. Good luck with your Colorado venture. Off-grid is the place to be. I'll keep an eye on my six, but frankly the government types don't scare me. What are they going to do—shut off my electricity? Richard Perez

Another Convert

Richard and Karen, here's a check for the *Solar4* CD-ROM and for my subscription renewal to your great magazine. Everyone involved with *Home Power* is definitely on the right track for the future of mankind's electrical generation. I say this since I am an instrumentation technician at a coal and gas fired power plant in eastern Iowa. Even though I find it fascinating and complex, we can't continue making electricity this way. We truly need to turn to the sun and wind for energy.

I hope to someday have a little place that is totally powered from the sun and wind, and not via the utility (coal or gas). *Home Power* gives me the inspiration and information to achieve that dream. I look forward to getting every issue and can't wait until you are a monthly magazine. Thanks, Marc Mohn, Lisbon, Iowa

Thanks for the kind words, Marc. I don't think we'll ever go to publishing monthly. We can barely keep up with a bimonthly schedule. Richard Perez

Solar Cooking in El Salvador

Home Power, I'd like to say thanks for sending your donation of the *Solar2*, *3*, & *4* CD-ROMs and the subscription to your superior magazine—all the way to El Salvador. *Home Power* is eliciting a lot of interest from Peace Corps volunteers here. Indirectly, the information you have shared has helped to provide initiative for a couple of volunteers to start solar electric projects. Without this info, I would not now be involved with a solar stove project involving the use of Suntoys panel cookers to demonstrate the concept and use of solar energy. There is a huge natural gas shortage right now here in El Salvador, and now is a great time for a real-life application of the concepts in your magazine.

I hope that in some small way our efforts here offset the loss of Bill Haveland to the Central American community. Moreover, I hope that people like you folks will act to fill the gap. This is why I write you today. For many months now, I have been attempting to gain access to either the plans, instruction pamphlet, or the product itself which goes by the name of "Sundyne" solar cooker, a fresnel lens reflecting design originally produced by Blackhawk Solar. This cooker was reviewed in *HP67* by Kathleen Jarschke-Schultze's *Home and Heart* column.

In her own words, "I even cooked pasta...I got the water to a good boil and added the pasta. These weren't flat egg noodles either, they were dried, cheese-stuffed tortellini. After I dumped them in, the water came back to a boil. Twenty minutes later, the pasta was done."

This was a better result than I'd ever heard of or seen from any solar cooking product. Those of you who have made box cookers or used panel cookers can really appreciate what I'm saying. I know that if this technology could be made available here, people would reproduce it cheaply and use it to fry platanos and cook beans throughout the day. It is getting harder and harder even to find wood here. I tried and tried to obtain access to some form of this product. Writing Blackhawk Solar several times, over a period of months, I finally got a response: They aren't making the cooker anymore, they just got back from vacation which is why they haven't written, and their company is too small to make a donation. Somewhat desperate, I wrote back and asked if they'd send me the plans or even just the instruction manual (which has detailed diagrams in it). I'd be willing to work with Salvadorans to make a low-cost design based on the cooker, and I would be willing to give Blackhawk Solar any and all intellectual property rights, copyrights, *anyrights*, associated with the invented product. That was several months ago, and they never wrote me back. So I wrote Kathleen, hoping she'd send me a copy of the instruction manual which she described as having a "very useful exploded view." It's all I had to go on—there are only fifty of these cookers in the USA, and she had one. She never sent me a response either.

I know that everybody's busy. We've got our lives to lead. But considering the incredible potential for this product here in El Salvador, where we have an annual average of around 11.9 solar hours daily, where people are actually rioting due to natural gas and cooking fuel shortages, could *someone* out there help me out? I'd be more than willing to cover mailing

costs if someone has a cooker to donate (or sell at a reduced cost). I'd love to get my hands on some plans or diagrams of any kind of fresnel lens cooker. The people here are definitely interested in what solar energy can do for them. (We even use solar energy down here to dry excrement while it is still inside of our latrines.) And, if the folks at Blackhawk Solar are reading this, my offer still stands. It would be an incredible contribution to environmental and social justice, the people of Central America, and the energy economy at large. Manten Paz, VCP Colín Gallagher, Cantón el Carmen, Rosario de la Paz, Depto. de la Paz, El Salvador, C.A. • gallagc@efn.org (I am able to check email once a month.)

Hello Colin. Tell you what, we'll send you a Sundyne cooker. We have one here in Karen's collection of solar cookers. She says that she can spare it, and that you will probably get better use out of it than she will. Perhaps you can reverse engineer it and make more of them—it's pretty simple and low tech. Blackhawk Solar never made this cooker, they just bought out the last ones that the factory made. I have no idea where this cooker was originally made, but perhaps a Home Power reader might. Keep up the good work in El Salvador! Richard Perez

Walking Lightly

Hey you all, first let me say that I worship the ground you walk (lightly) on. Ever since I first ran into you as a child at the Oregon Country Fair in the mid to late 80s, I have been enjoying and coveting your fine publication whenever I could find it. I was very happy to finally get to a position where I could subscribe. Your CD-ROMs are a godsend to all of us info-starved renewable buffs.

Unfortunately I am not yet a homeowner. (I was born in one of the most highly priced and sought after areas of the country and most of the locals are being bought out for astronomical prices, leaving the younger generations without hope to live where they were born unless they want to join the system full force.) So I have not had the chance to go off-grid yet, but the knowledge is there, thanks to you.

I have, however, spent the years learning how to build and design from the ground up. I own my own environmentally friendly contracting company and am 100 percent zero growth, which means absolutely no development of raw land, at least here. I have long since come to the conclusion that modern building techniques are insane. I do find it hard to live lightly on the earth and actually make enough to be able to afford property, but I am still trying.

Some friends of mine have put together a company on the Web called Millennial Goods (millennialgoods.com) which provides RE sales and installations. I am onboard with them as an installer. Right now my only personal RE resource is a Solarex 120 watt panel with a Trace micro-sine inverter, but I've rigged it up to supply backup remote power on my work truck. I used this setup when I recently drove to Belize to help some friends build down there. My next truck of course will be biodiesel, but for now I use what I've got. Anyway, I love you guys and gals at *Home Power*, and thank you for ever expanding my knowledge on the subject of sustainability. Once again, many thanks! Jeffery Miottel, aka El Jefe de Biosmell • biosmell@aol.com

Take the Bus

Driving vs flying to energy fairs: If you really care, take the bus! Dear Richard, Ian, and all the wonderful people at *Home Power*:

This is to respond to Rudy Rutterbusch's letter in *HP73* regarding the fuel needed to fly vs drive to energy fairs.

Since people use, on the average, just as much energy for transportation as they do in their homes, I am glad that you care about finding the most fuel-efficient way to travel. Rudy, regarding your numbers for airplanes: 100 passenger-miles per gallon (pmg) seem to be too optimistic. You are assuming a non-stop flight, with all the seats occupied. In reality, you need to count in the fuel used for stopovers (it takes a lot of fuel to climb to 30,000-33,000 feet), and for empty seats. Looking at the national annual statistics of roughly 500 billion passenger miles flown and about 17 billion gallons of jet fuel used for commercial passenger flights, the national average is somewhere around 30 pmg.

Flying also dumps a good amount of pollutants right on the city from which you are taking off, as opposed to distributing them evenly along the way. (When comparing emissions per gallon of fuel used, airplanes are not much different from cars—they do not have catalytic converters, but they are usually better maintained.)

If you really care about minimizing your fuel use, consider taking a bus. The average occupancy reported by Greyhound is 24 passengers. If a bus gets 6–7 mpg, this translates into 144–168 pmg. Plus, both times I went to MREF, they dropped me off a five-minute walk from the gate. Michal Vojtisek-Lom, 240 Meyran Ave., Pittsburgh, PA 15213 • 1-877-6-MICHAL michal@warren-wilson.edu

Way to go, Michal! You're a great example, and it was fun to meet you at MREF last year. I'm not sure Greyhound would let this ragged crew onto one of their buses, and our fair gear would max out their cargo space. But if they did let us on, after 48 hours of hearing us discuss em-dashes, page bleeds, and solar bozoship, they'd gladly let us off at MREF... Ian Woofenden

Net Metering—Laws & Morality

Dear Richard, first let me say that modern technology may be wonderful, but after three months of being down (computer mostly) with two floods and one major lightning strike, there is nothing like good old fashioned paper magazines (*Studebaker TW*, *National Geographic*, and *Home Power*, for example).

In the latest issue of *Home Power* (*HP73*), two letters concerning RE systems and net metering deserve comment. First, I agree that Tom Starrs has been very helpful in the legal aspect of renewables and legislation among 30 states (*HP73*, page 128). I hope that many *HP* readers respond with the info he asked for. As long as the IOUs keep RE segmented and out of touch with each other across the country, there is little chance for RE to make headway. Also, it is better to make the changes ourselves than let politicians from Washington, DC do it later.

The second letter was from Paul Gipe concerning net metering limits (*HP73*, page 130). I have great respect for Paul and his knowledge of RE, but in reality there lies a very different problem than the one Paul sees. Making laws and rules concerning RE is only one step in the process. As Paul states, Iowa is one of four states with no limit on wind turbine size. His desire to have everyone write Tom Starrs and ask that all limits on renewable production be removed sounds great.

But laws and morality seem to be only for those willing to follow them. The much more difficult problem is to make the utilities

(Mid American Energy to CalEnergy) do what is mandated. And to make this problem even more difficult, getting the utilities board to make the utilities follow what rules and laws there are. Iowa passed an AEP law in 1983 that required the utilities to build their own renewable projects and also to accept net metering. It took 14 years of legal battles to get the Iowa Utilities Board to finally set sanctions so the IOUs would follow the law. One year later, 257 Turbines were built and online. Iowa is now the largest producer of electricity by wind in the country, but do not give credit to either the utilities or the utilities board. They both dragged their feet all the way.

As to the second part of the 1983 AEP law—net metering—the law may say no limit on size, but the utilities’ “keep it in court” attitude here in Iowa negates any and all reference to Iowa’s “no top limit” in renewables production. Just recently a district court in Iowa found that FERC will rule in Mid American’s favor on their latest attempt to stop net metering in Iowa. Mid American has now filed that finding with FERC as one more reason to not net meter. Talk about convoluted and intertwined legal battles! The really big hurt to renewables (and IRENEW) in Iowa, in my opinion, was the Iowa Utilities Board defense against Mid American by an employee opposed to renewables and IRENEW female board members. With help from friends such as this, the case was already decided. Net metering lost.

Though the law says “no limit on renewable production” in Iowa, the above is just one example of many ways to keep it from becoming a reality. Tom Snyder, Board member and past president of IRENEW • studegh@earthlink.net

Agenda Argument

Richard Perez, *Home Power* magazine: Thanks for sending me the email about the marketing survey. I live in an older home in a city supplied with electricity from the city’s own utility. The utility gets its power from the Bonneville Power Administration (BPA). The power has been reliable, and more or less reasonably priced even though I would like to be able to pay less. I do not have any other power source now except the local public utility.

Most of the local power comes from hydroelectric dams on the Snake and Columbia Rivers. Some power comes from Washington State’s only nuclear reactor just north of town. Hydro power is a renewable energy source—in effect powered by the sun—that is environmentally benign. This is pretty much the same thing as your magazine is pushing, except it is done on a much larger scale than any home or farm system.

There are those who are opposed to this hydro power because they believe that the dams are hurting the fish runs. As a result, these people want to see the dams removed or breached to allegedly help the fish. I do not know of anyone who has any thoughts of the “fish be dammed,” but the whole problem has been blown out of proportion because the truth of the matter is hidden in the rhetoric of both sides.

Your magazine should be supporting retaining the existing environmentally sound hydro power dams on the Snake and Columbia Rivers. The other alternative, whether you like it or not, should these dams be breached, is going to be more fossil fuel burning power plants spewing noxious gasses into the air, poisoning us all. As a practical matter, the systems your magazine backs, while certainly admirable, will be insufficient to take up the slack should these dams be breached in the name

of supposedly saving the salmon. There is already a shortage of electrical power looming across the Northwest and beyond.

So you see, my home is already powered by hydro power, free from the sun’s energy, supplied by a utility system that works more or less efficiently and is priced somewhat reasonably. That aside, I would like nothing better than to have my own independent sources of energy such as solar, wind, or whatever. I have been interested in this concept for many years. The problem is that I can not justify the additional cost of installing any such system on my house in the city. Wind power does create a certain amount of noise from the propeller and gearbox which my neighbors in very close proximity would probably complain about to the authorities. Solar panels have their own particular problems when used in the city, such as reflections, sight, etc.

If I had a home located out in the country, as are just about all those systems that you publish nice articles and pictures about in your magazine, then yes, I would probably go the renewable energy route just as you guys are pushing. I would do this because it would be the right thing to do. That is all the justification I would require. I would not have to do this because of some contrived boogie man (public utilities). I would not do it just because I had an irrational hatred for the existing utilities as espoused by many of your writers and editorial staff. What I am attempting to say is that all too often your magazine drops down from the professional level of technical writing to that which is nothing but muckraking, or a personal vendetta against anything that smacks of a public utility operation. You can not rise to the level of the figure at the top of the totem pole by chopping down the pole itself.

It’s too bad your magazine has to resort to these methods of pushing its agenda, because the concept of renewable energy sources on smaller scales is a great one—one that can stand on its own three legged tower with its turning propeller, without the necessity of an endless stream of diatribes bashing the utilities. Your magazine is like the patient cursing the doctor (utility) who is keeping you alive (supplying customers with power) by sometimes making you a little uncomfortable until you (the home energy business) are strong and healthy enough to make it on your own.

Otherwise, you have an excellent magazine, technically competent, timely, covering a very worthwhile subject. One that will eventually become an accepted standard based on its own merits without having to put anyone else down. But I suspect that you won’t change your ways, because that might be an admission that, somehow, you might have been wrong back in the past when it comes to the endless utility bashing you so happily engage in. It also wouldn’t set very well with some of your more rabid supporters, who rapidly froth at the mouth every time the word “utility” is spoken or, perish the thought, even comes to mind. It is a real sad situation for a magazine with such a great promise otherwise.

Because of the availability presently of utility power from the BPA grid, there isn’t much wind and solar activity here locally on an individual or personal basis. Until there are problems with the supply of utility power, or the cost of utility power rises significantly, most people here are not going to look seriously at going wind or solar. Small-scale water power is not too viable in the local area here because of a lack of streams, being a dry desert area.

I came across a large installation (large for this area) of wind turbines just across the Oregon state line some 30 miles from where I live. The blades are 45 meters across and the generator cabs 55 meters high—impressive to say the least. I was told that this system went into operation in November of 1998. There was never anything said in the local Tri-City Herald newspaper about it until just last week when it was mentioned as an aside in a series of articles about a projected looming power shortage in the Pacific Northwest. I understand that Florida Power and Light owns the installation and that they have a 30 year contract to supply power to Portland Power and Light.

What was interesting was that this system did not seem to be creating a lot of noise while it was running. A previous proposal for a wind power installation caught all kinds of flack because of the alleged high noise levels along with a host of other contrived opposition to the installation. The local paper covered this story in great detail.

This subject has pretty well been ignored by the public used to the massive amounts of cheap power from the BPA Grid. This subject might be a good one for your magazine to explore because it bolsters the concept of de-centralized or diversified sources of power independent of utility sources.

P.S. While I may live in Richland, Washington, the Atomic City, I do not see more nuclear power as being a real option with the present political climate. People like to point out the dangers of nuclear power and I admit that there are some. I would rather live next to a nuclear power plant than live where tornadoes come out of the night killing people and damaging property. I guess it all depends on what a person's perception of danger really is. I was in Texas visiting my daughter last spring. The potential tornado weather worried the living daylights out of me while I was there, and as much as I love my daughter and son-in-law, I was glad to safely get back across the Rockies and home. I did like all the windmills that pump water all over that part of the country.

Yeah, I know you probably don't like what I have written. You probably think I am one of those utility supporter assholes, but read it once again, slowly. I would like to see *Home Power* become even a better voice for environmentally clean power than it is, and not just remain as an ankle biter on the fringes of the power business, yapping at everything in sight that doesn't quite agree with the editorial standards presently in vogue. Think about it! Russ Hughes, Richland, Washington
wa7aco@owt.com

Hello Russ, and thanks for your comments. One thing that is always interesting about Home Power is the diversity of readers and their opinions.

You are not alone in thinking large-scale hydro is environmentally sound, but most who do are utility-oriented folks like employees or stock owners. Even most of the utilities that sell "green" power won't go to the point of including large-scale hydro. Huge dams are the absolute worst things we can do to a river ecosystem. Nothing else has an immediate, up-front effect like the massive environmental destruction of huge dams. Other energy technologies are more benign in appearance—it is only upon closer examination that fossil fuel and nuclear problems come to light.

It is not disappearing salmonids alone that have environmentalists up in arms over dams. It is the ruining of

entire ecosystems, the end of freshly deposited soils, the displacement of indigenous peoples, the resulting crisscrossing of large tracts of land by power lines, and the centralization of power that all add up to make large-scale hydro unpalatable.

Yes, your local hydro power is cheap. The rest of us subsidized the dams for you, and continue to lose our communally owned resources (public rivers and land) which are given away so that a handful of wealthy people can make more profit.

Home Power is not just a journal of technical writing. It is not just a magazine for people who have to make their own power because of their remote living situations. It is also a magazine for people who want to make a difference environmentally and socially. For most people, economics are not the motivation for wanting renewable energy. That's why we regularly get on the soap box. As people hear about environmental and social problems from large-scale, centralized energy sources, their desire to use homemade renewable energy increases.

Utilities want us to be dependent on them and like it when people think as you have. They spend incredible amounts of money trying to convince customers and employees that they are doing the right thing. It's kind of like the yellow smiley-face that adorns the WalMart ads—it looks attractive on the surface, but closer scrutiny reveals pure greed and resulting social and environmental decay. Even you appeared to accept the utility position that wind farms were too noisy to deploy until you heard one yourself. Allow the WalMart into your neighborhood, and there go your locally owned and operated stores—just like what happened with our energy supply system.

Utilities are anti-environment and against homemade power. They have been for years. Right now, there are not big bucks in small-scale renewable energy, so they continue to fight against it to keep control of our energy supply and its flow of money. It is up to us to spread the word on how and why so that we can grow the industry in spite of the utilities.

Utilities do whatever they can to suck up federal and ratepayer dollars so they can increase their profits. It's not as if there was a giant pool of free money out there that they wanted access to. They influenced the creation of that pool of money specifically for their own uses. Just imagine if all the R&D and other subsidies that the hydro, fossil fuel, and nuclear industries got their hands on had gone into more benign and locally distributed technologies like PV.

Had our tax and ratepayer dollars gone into renewables, or at least not into polluting technologies, you still would have your clean and cheap power; and the Columbia and Snake rivers would be running wild and free, along with the wildlife and ecosystems that were dependent on them.

I hope we will still arrive at that point. It's just taking a lot longer than it should because of the utilities. Michael Welch

Hello Russ. You are correct when you say that renewable energy equipment cannot yet meet this nation's demand for electric power. The RE resources (sun, wind, and falling water) are there, but the hardware is not yet available in sufficient quantity. And it never will be if we don't buy it, install it, and use it. We can't rely on utilities to forge ahead with renewable energy. They have a major problem with RE—the fuel is delivered free daily. You can't put a meter on sunshine.

Just because you live in BPA hydro country doesn't mean that the electricity you use comes from hydro. BPA sells electric power to the highest bidder. Recently most of the hydro power made in the Pacific Northwest is being shipped to Southern California because they pay a higher price. Folks in BPA country wind up using electricity produced by coal-fired plants in Idaho.

I'll stop ragging on utilities when they use mostly RE instead of coal, nukes, and big-time hydro. I'll stop criticizing utilities when they allow independent RE producers to gracefully place their RE on grid. I'll stop cutting down utilities when they put our environment ahead of their profits. Until then, you will find me biting their ankles every chance I get. Richard Perez

Downloading Home Power

I recently found you on the Web, and have downloaded every issue of your magazine since I found it (HP71, 72, & 73). Since I live in Sweden, I can't find another magazine for those of us interested in solar (or other renewable) energy. Sometimes in your magazine you refer to older HP issues and I can't seem to find them anywhere on the internet. Since I am a ham radio operator, this started out as an interest for emergency power and mobile use, but with your excellent magazine as a guide, I am now getting more and more interested in powering a small summer house with nothing but PV and wind. If that works out well, I might try to use it during winter, too.

So, if you have some idea of where I can download complete magazines from the past, I would appreciate it a lot. (I do my downloading on a modem, and although it takes a fair amount of time, I still think it is worth it. If there is a mirror site in Europe, I might get faster downloads. I could bring my computer to someone with a fast internet access too, but only if I could download many complete magazines at one time.) Thanks for your time! Gustaf Wenngren, Tranbärsvägen 10e, 904 34 Umeå, Sweden • sm2vjx@algonet.se

Hello Gustaf. We only post the current issue of Home Power on the internet for free download (www.homepower.com). If you wish to get information from back issues and you have a computer, then your best source is our CD-ROMs (see ad under Home Power CD-ROMs). The actual working electronic index, which spans many issues, makes the mass of information on these CD-ROMs many times more useful. You can find exactly what you are looking for very quickly. The cost is small (US\$96 shipped international via air mail to Sweden) for all three CDs covering HP1 through HP70. We also have audio lectures and video clips on the CDs as well as system sizing software (an Excel template).

We have been considering placing all of our back issues in a "library" on our Web pages. Frankly, if we do this, we will have to figure out some scheme for charging the users of this information. Have any ideas? Sales of our back issues, both on paper and on CD-ROM, are one of the major items that keep Home Power alive and solvent.

While we give our current issue away for free to anyone who can download it (about 45,000 to 50,000 folks), we also have about 25,000 readers who purchase the magazine in its printed form. We are glad to see the information flow, but if it is to continue to flow from us, then we need to stay in business.

What began as a home-based business for Karen and me has grown into a corporation with twelve employees, a warehouse, and taxes to pay. In addition to this we have the dreaded three

Ps of publishing: printing, paper, and postage. We realize that on the internet, there are no three Ps. This is why we give the current issue away. We're hoping that many internet users will subscribe, and buy our back issues on CD-ROM. This financial participation by our internet readers makes posting our current issue for free a financial break—even for us.

I'd invite any reader suggestions or comments about establishing a "Home Power Library" on the internet. We have the technology—we just don't know how to implement it without going broke. Richard Perez

Smaller Systems

Hi Richard, I love your magazine for its insightful look at leading edge RE technology. I look forward to each and every issue. The ingenuity displayed by your writers and editors on RE projects is simply amazing. They are really informed and anxious to share their hard earned knowledge. Thank you for publishing *Home Power*.

In the future, would it be possible to feature some smaller version products? By this I mean removable, portable systems that don't require major investments in money and property. You see, I am a renter. Yes, one of those. Any small unobtrusive system stories would be greatly appreciated—something the landlord would not object to. Keep up the good work! George Holt, Bellevue, Washington

Hello George. We have been running articles about smaller, portable systems. See the article by Dick Anderson on page 24 of this issue. Also see the article by Eric Kindseth and Nicole Burbridge on page 8 of HP71. We try to run at least four or five of these smaller system articles yearly. If you or other readers have small systems that you'd like to see featured, let us know! Richard Perez

Utility-Free

I am in the process of designing an off-grid home that is on property over \$40,000 from where the power line ends. So I am using your mag and advertisers to educate myself on RE. Since I never paid any attention to electricity before, it is definitely a learning experience. But I am loving it, and being eventually free of the utilities is definitely positive. Norm Pedersen pedersen@tscnet.com

Hello Norm. With your utility wanting US\$40K for the line extension, you can save a pile of money and have independent renewable energy at the same time. I generally figure that any home which is 1/4 mile off-grid can have clean RE cheaper than installing utility power. Go Solar! Richard Perez

Mill Hydropower

We are interested in having our mill generate hydroelectricity. We also have interests in wind, solar, and geothermal power, but our main concern is our mill. It is a 150-year-old planing mill that operated as late as the 1960s. It has an aqueduct that brings water from our pond to an internal water wheel. If you could offer any guidance, we would greatly appreciate your assistance. Thank you and our best regards, Susan and Gerald Hartman • smpr_spcto@aol.com

Hello Susan and Gerald. The old mill sites that dot the eastern states typically used overshot water wheels. These wheels performed mechanical work, like the planing that was done at your site. Because the water source at these sites often have low head (vertical fall), the wheel operates at a low rpm. In order

to produce an rpm high enough to generate significant electricity, the addition of substantial gearing is required. Check out HP37, page 6, for a good overview of overshot hydro wheels for power generation.

In some cases, it makes sense to retrofit these overshot wheels with more efficient Francis-type turbines. I'd suggest contacting MacLeod Hydro. Ron has years of experience retrofitting old mill sites with both stand alone and utility interactive (UI) hydro electric systems. Joe Schwartz

Hello Susan and Gerald, We recently had an SEI hydropower workshop here in the Northwest. We were fortunate to have Ron MacLeod (see the cover story of HP23) come out from Pennsylvania to speak to our group. He shared a slide presentation with us that was a real eye opener to me. Out west we think mostly of high head hydro sites with pelton and turgo turbines. But there are thousands of low head sites like yours all over the country, and world. Ron talked with us about installations he's done that generate substantial amounts of energy on very low heads. His slides included a system that uses a side-shot water wheel. I suspect he could give you the guidance you are looking for. Here's his contact information: Ron MacLeod, MacLeod Hydro, 2131 Harmonyville Rd., Pottstown, PA 19465 • 610-469-1858 • Fax: 610-469-1859 microhydro@dplus.net. Ian Woofenden

Commercial PV Load analysis

Dear Home Power, I am pleased to visit your Web site and go through the load analysis. It is very useful and a convenience for preparing my own load sheet. Even for me, I spent about 15 minutes to complete it which is about a quarter of the time spent reading a newspaper daily.

Here, I would like to introduce myself as a research student from electrical engineering discipline at Hong Kong Polytechnic University. Currently, I am enrolled in the research topic of "integrated resource planning incorporating with renewable energy and environmental policies in HK." Part of the project requires me to carry out a feasibility study of using passing solar system in residential and commercial sectors. The load analysis is very helpful for the project implementation.

1. In order to formulate the complete analysis, would you be kind enough to provide the following information: How about the initial installation cost, i.e., overall average cost, of typical passive solar system (including all sorts of components—battery, inverter, wiring for DC purpose, fuse, circuit breaker, regulated controller, etc., and of course the PV cells)? For example: U.S. dollars per watt. It is quite critical to consider the incentives towards the end consumers.

2. How about the maintenance cost (especially for lead-acid type batteries)? Usually, the photovoltaic system is quite long lasting compared to the batteries.

3. Did you also carry out load analysis for commercial sectors, like ordinary office energy consumption? If so, what are the comparison you made?

4. Do you have any rough idea of installation cost for setting up a passive solar system in existing building (residential vs commercial)?

Finally, thanks a lot in advance and I do hope the "wordy" message will not cause any inconvenience. Yours faithfully, Ben

Pang • 852-2636-1898 • Fax: 852-2630-0779
maxocean@netvigator.com

Hello Ben. Let me try to answer some of your questions.

1. We assume an average cost of about US\$10 per watt of photovoltaic (PV) system, installed. So, a 1 KW PV system will cost about US\$10,000. This is figured for residential systems.

Please note that "passive" solar is a term used for solar thermal systems—using sunlight to heat a living space, or sometimes hot water. The term "active" solar also refers to thermal systems, usually those involving more complex systems of heat transfer, like fans, pumps, and heat exchangers.

Photovoltaics make electricity directly from sunlight. Heat is not a necessary (or helpful) variable. Remember, a well designed home will use many systems to obtain the energy needed. Passive solar heat and hot water will lessen the need for PV electricity in the system.

2. Lead-acid batteries can last 10 to 12 years if maintained properly. This means that the batteries need to be charged regularly, equalize charged periodically, and watered when needed. The way an RE system is used will have a large effect on how long batteries will last. This is not expensive maintenance. The cost is for the labor.

3. Commercial applications are very much like residential systems in terms of sizing loads. Add up daily energy use and size the system to meet that need. There are some differences, however. In a residential system, the user can adjust the energy use to match variation in the resource (sunshine). For example, the user might wait to do laundry or pump water until the cloudy weather goes away. In a commercial situation, work usually needs to proceed regardless of the weather. You can't stop work and send employees home just because it's cloudy. Here at the magazine during deadline, we need to run our computers no matter what the weather is doing. In the winter, we often use a backup gasoline generator to keep up with our energy needs.

Another difference between residential and commercial RE systems is the amount of power needed. Many manufacturing companies use a lot of energy every day. RE may be too expensive to meet these energy needs. The equipment needed can be scaled up, and you should be able to design this kind of system yourself. The difficult question is cost. You are an engineer—work the numbers for your location and economy.

4. Richard Perez, Home Power's co-founder, estimates that the cost for professional installation of an RE system is about 5 to 7 percent of the total system cost.

I hope that this information is helpful to you. Ben Root





Adopt a Library!

When Karen and I were living with kerosene lamps, we went to our local public library to find out if there was a better way to light up our nights. We found nothing about small scale renewable energy.

One of the first things we did when we started publishing this magazine twelve years ago was to give a subscription to our local public library.

You may want to do the same for your local public library. We'll split the cost (50/50) of the sub with you if you do. You pay \$11.25 and Home Power will pay the rest. If your public library is outside of the USA, then we'll split the sub to your location so call for rates.

Please check with your public library before sending them a sub. Some rural libraries may not have space, so check with your librarian before adopting your local public library. Sorry, but libraries which restrict access are not eligible for this Adopt a Library deal—the library must give free public access. — Richard Perez

To Adopt a Library write or call

Home Power®

PO Box 520, Ashland, OR 97520 USA
1-800-707-6585 or 541-512-0201 or FAX 541-512-0343
hp@homepower.com • www.homepower.com

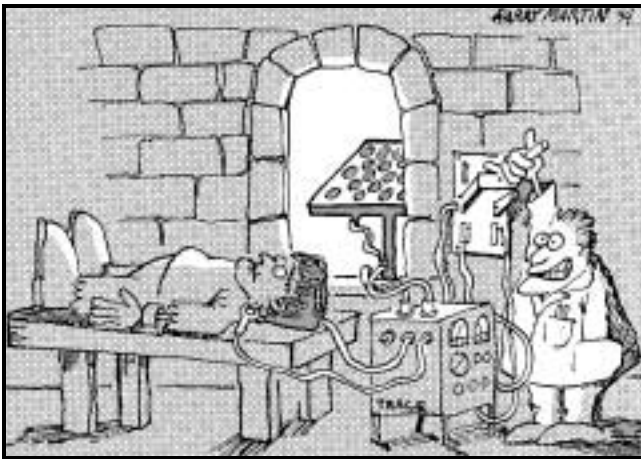

Need a renewable energy quick-start for the ole' brain?

Home Power Quick-Start Subscription Special

our last six available issues, plus a one year surface subscription...all for \$45 inside USA
(Call for International Rates)

Home Power Magazine

P.O. Box 520, Ashland OR 97520 USA

800-707-6585 in USA, or 541-512-0201
VISA or MC



Solar - Powered Soap?

The natural ingredients of our soaps and bodycare products derive their energy from the Sun, as do our home and business.

Discover the many items for home and personal care in our catalog:

Simmons Handcrafts.

42295 Hwy 36, Bridgeville, CA 95526

Statement of Ownership, Management, and Circulation (Required by 39 U.S.C. 3685). 1. Publication Title: HOME POWER 2. Publication #00-8699. 3. Filing Date: September 24, 1999. 4. Issue Frequency: Bi-Monthly. 5. Number of issues published annually: 6. 6. Annual Subscription Price: \$22.50. 7. Mailing address of known office of publication: P O Box 520 (10,000 Copco Rd.), Ashland, OR 97520. 8. Headquarters of general business office of the publisher: P O Box 275 (10,000 Copco Rd.), Ashland, OR 97520. 9. Names and addresses of Publisher, Editor, and Managing Editor: Publisher and Editor-in Chief, Richard A. Perez, P O Box 520 (10,000 Copco Rd.), Ashland, OR 97520; Publisher and Managing Editor, Karen L. Perez, P O Box 275 (10,000 Copco Rd.), Ashland, OR 97520. 10. Owner (if owned by a corporation its name and address must be stated immediately there under the names and addresses of stockholders owning 1% or more of the total amount of stock: Home Power Inc., P O Box 275, Ashland, OR 97520. Richard and Karen Perez, Ashland, OR, Dale and Marilyn Hodges, Medford, OR, Scott and Stephanie Sayles, McMinnville, OR Virginia Deano, Arabi, LA. 11. Known bondholders, mortgagees, and other security holders owning or holding 1% or more of total amount of bonds, mortgages or other securities: None. 13. Publication Name: Home Power. 14. Issue date for circulation data: Issues 68-73. 15. Average no. of copies each issue during preceding 12 months — a. Total no. copies (net press run) 25,583. b. Paid and/or Requested Mail Subscriptions: (1) paid or requested mail subscriptions (include advertisers' proof copies/exchange copies): 6,917 (2) Paid In-County Subscriptions: 50 (3) Sales Through Dealers and Carriers, Street Vendors, Counter Sales, and other non-USPS Paid Distribution: 12732 (4) Other Classes Mailed Through the USPS: 3058 c. Total Paid and/or requester circulation: 22,757. d. Free distribution by mail (samples, complimentary, and other free) (1) Outside-County: 210 (2) In-County: 4 (3) Other Classes Mailed Through USPS: 726. e. Free distribution outside the mail: 65. f. Total free distribution (sum of 15d and 15e): 1005. g. Total distribution (sum of 15c. and 15f.): 23,762. h. copies not distributed: 1821. i. Total (sum of 15g. and h.): 25583 j. Percent Paid and/or Requested Circulation: 95.8%. No. of Copies of Single Issue nearest to filing date — a. Total no. copies (net press run) 26,500. b.(1) Paid/Requested Outside-County Mail Subscriptions (include advertiser's copies and exchange copies): 7076. (2) Paid In-County Subscriptions: 43 (3) Sales Through Dealers and Carriers, Street Vendors, Counter Sales, and other Non-USPS Paid Distribution: 13,185. (4) other classes mailed through the USPS: 2140. c. Total Paid and/or requester circulation: 22,444. d. Free distribution by mail (samples, complimentary, and other free): (1) Outside County: 176. (2) In-County: 6. (3) Other Classes Mailed Through the USPS: 730. e. Free distribution outside the mail (carriers and other means): 65. f. Total free distribution: 977. g. Total distribution: 23,421. h. copies not distributed: 3079. i. Total (sum of 15g. and h.): 26,500. Percentage of paid and/or requested circulation: 95.8%. 16. This statement of ownership will be printed in the December 1999/January 2000 issue of this publication. 17. I certify that the statements made by me above are true and complete. Karen L. Perez, Publisher and Business Manager 9/24/99.



Richard Perez

©1999 Richard Perez

On the Road to Flagstaff

From 16 to 22 September, several of the *HP* crewmembers hit the road for Flagstaff, Arizona and the second annual Southwest Renewable Energy Fair. Joe Schwartz, Michael Welch, and Karen and I drove in one rig, while Don Kulha drove his monster van packed with all the stuff required to do an energy fair. See my report on page 66 of this issue.

We drove to this fair because we were just plain tired of airlines, airports, and the time and space disorientation we experience from flying. While the journey was longer, at least we knew, in our minds and bodies, where we actually were at any given point in time. And we got to see interesting sights along the way, which is more than you can say for air travel.

We traveled to Flagstaff by going south down the central valley of California, then east across the Mojave Desert. Only by surface travel can you truly appreciate what a huge and diverse state California really is. The central valley is a marvel of industrialized agriculture, while the vast Mojave Desert is virtually unpopulated and unused, a great place for massive solar electric and wind projects.

On our return journey from Flagstaff, we headed west and north for a visit to the Grand Canyon. Michael and Karen had never seen this natural wonder, so we decided that *Home Power* business could wait. See the photo on page 6 of this issue. If you want to feel very small and short-lived, visit the Grand Canyon. The temporal and spacial dimensions are staggering. Just looking at it really puts the human race in our proper natural place.

After the big canyon, we stopped at Hoover Dam. This project is a tribute to man's ability to bend nature out of shape. Even though big hydro is probably the least polluting way that utilities make electricity, Hoover Dam still gave me the willies. The whole scene looks like it came from another planet and belongs there. Part of the crew listened to the ten minute canned utility propaganda rap which claimed that "Hoover Dam has tamed the menace of the Colorado River." I left this massive hydro project wondering where the menace really lies...

Oregon's Net Metering Bill

The situation with Oregon's net metering bill may be better than I originally thought. Ambiguities in this bill, the result of compromises with Oregon's utilities, are being ironed out in meetings with Oregon's Public Utilities Commission (PUC). It seems that the PUC and the utilities have realized that the installation of a second meter, paid for by the utility, is not cost effective. Still under discussion are whether or not the system will zero out (determine parity) on a monthly or yearly basis. Oregon's RE activists prefer a yearly determination of parity, while some utilities want to zero out monthly. Stay tuned.

Guerrilla Solar on TV

By the time you read this, guerrilla solar will have been featured on Canadian television. On 24 September, a crew from Nexttv in Toronto came to Funky Mountain Institute to discuss the guerrilla solar movement. Along the way, they interviewed two solar guerrillas and shot video footage. Don't ask me who or where—I can't say. This syndicated TV program, *New.Next.Now—n3tv*, will be viewed all across Canada and in many places around the world. May this TV program give every pollution-belching utility the acid indigestion they so richly deserve.

Fine Business in New Orleans

On October 1st, Karen and I flew to New Orleans to participate in a three day meeting of BP/Solarex solar people. Just listening to the presentations showed me why BP has captured a substantial portion of the U.S. PV market in a very short time. Their focus is on putting the lion's share of the profits into the hands of their dealers.

After years of being at the bottom of the food chain, it is now possible for installing dealers to make a decent living at their profession. This attitude, coupled with high quality products and outstanding service, gives BP/Solarex a decided edge in the solar business.

Not all was corporate meetings, however. After hours, we had a great time cruising Bourbon Street, listening to fine live music, and participating in the party madness. Karen, a native of New Orleans, commented that every weekend is now a mini Mardi Gras in New Orleans, although they now seem to be watering down the Hurricanes (a special New Orleans zombie cocktail).

Home for the Winter

After a summer spent mostly on the road, I'm glad to be home for the winter. All the energy fairs and business trips were lots of fun and very productive, but hey, there's no place like home, regardless of how funky it is. There is something entirely satisfying about getting the firewood and the winter's cache of grub. It's a feeling of permanence and self-sufficiency. With Y2K coming soon, I must admit that Funky Mountain Institute has never looked and felt more like the palace it really is. I'm looking forward to getting snowed in. I can use the quiet time for all those projects that I never seem to get around to.

Home Power's New RE System

Part of getting ready for this winter is establishing a new RE system here. Our system has grown over the years into what may be the biggest 12 VDC system in the world. It cycles about 15 KWH of RE almost every day, and should have been converted to 24 volts years ago. We are splitting up the PV modules and using about two thirds of them in a new 24 VDC system. We are still keeping the venerable old 12 VDC system up and running.

Joe Schwartz is the major wrench bender on this big project. He's been working full time for *HP* for over a year now, and it's finally happening. When you're homesteading in the middle of nowhere, things don't happen quickly, even if you have a full-timer like Joe on your crew. Along with all the

other projects here, Joe had to design and build the power room. Then we had to get all the gear together and come up with an effective system design. Now everything is getting wired and coming online.

As I write this, my Mac, and the entire editorial office, is powered by the new 24 VDC system. This system has 1,750 ampere-hours of L-16 lead-acid batteries and two inverters, an Exeltech 4 KW MX series unit and a Trace SW4024. Joe has already switched over the biggest array (sixteen BP590 PVs on a dual-axis Wattsun tracker) to this system and it's beginning to come alive. Look for a feature article on this new system in the near future.

Thanks to Joe's outstanding construction abilities, we're trying several new ideas. A superinsulated, hydronically-heated battery box keeps the battery temperature within two degrees of 74°F. It draws heat from two solar collectors on the roof of the bathhouse, and has a thermostatically controlled circulation pump. We are also trying out the newest and latest PV charge controllers. When these systems are finally finished, *Home Power* will have the ability to test just about any piece of RE hardware, either 12 or 24 VDC.

The whole power room will be wired for computerized data acquisition. Michael Welch is putting together a special Windows computer to do the data logging. Joe has laid almost 2,000 feet of heavy power cables connecting the main house/editorial office to the new power room. Next comes over 1,000 feet of instrumentation and data cable. We will be able to select any one of four inverters and direct the power to any one of over a dozen house/office circuits. We'll be all set up for comparison testing of RE components and appliances. Everything can and will be minutely (make that millisecondly) logged. While we need the electricity out of these systems, we also want data on how they operate.

RE Wrench Email List

We have decided that it's time for renewable energy Wrenches to have their own email list. An RE Wrench is someone who makes their living in the field of small-scale renewable energy. When someone posts a letter or comment to this list, then everyone on the list receives it and has the opportunity to put their two cents in. We envision this list as a place for Wrenches to swap hints and kinks, discuss NEC issues, and to just plain talk shop with each other.

We are limiting the membership of this list to the pros. This list is not intended for novices or for folks who are seeking technical help. Wrenches are busy folks and we don't want to overload them with general questions—general info is *Home Power's* job.

If you are in the small-scale RE business and wish to subscribe to the Wrench email list, please contact the list's master, Michael Welch (michael.welch@homepower.com). This list is now up and running. We're already learning from each other in addition to having lots of fun.



Richard and Hijo contemplate the river of time.

Happy Y2K

I can't let this year end without passing on our best wishes to all our friends and readers, from the entire *HP* crew. By a total accident of fate, we're all going to watch our arbitrary calendar make a big change. I hope that we'll all make this change gracefully, and that our machines will also. Back in 1969, I would not have given myself a rat's ass of a chance of seeing the year 2000. What with Vietnam, the political climate, and my radical tendencies, I wasn't sure of living out the year, much less seeing this calendar change. Now, we're all here and worrying about what will happen next.

I'm 54 years old. I've seen enough less-than-believable reality to know that life is far stranger than we can ever appreciate. I often talk to Hijo (pronounced *ee-ho*), a 40+ year old mule who lives with us. He came here 18 years ago as a refugee from the dog food factory. While he doesn't say much, he's a good listener. Hijo knows time—he's got arthritis and most of his teeth don't work anymore, so we have to grind up his carrots for him. The soft shine in his old eyes shows me that he understands what I tell him. Life is a delicate balance between "Don't mean shit" and "Be happy, don't worry." I can only wish myself and all of you the peace I see in Hijo's eyes.

Access

Richard Perez, *Home Power*, PO Box 520, Ashland, OR 97520 • 530-475-3179 • Fax: 530-475-0836
richard.perez@homepower.com • www.homepower.com



Solar Hydrogen Chronicles

Edited by Walt Pyle • First Edition 1998

A collection of articles from *Home Power Magazine* on Hydrogen Technology for small-scale systems

Hydrogen Production

Hydrogen Purification

Hydrogen Storage

**Utilization for Cooking, Heating,
& Electricity Generation**

118 pages of useful information

Extensively Illustrated • \$25 + \$3 S/H = \$28

H-Ion Solar Inc.

6095 Monterey Avenue

Richmond, CA 94805 USA

phone: 510-237-7877 • fax: 510-232-5251

email: hionsolar@aol.com

website: www.hionsolar.com

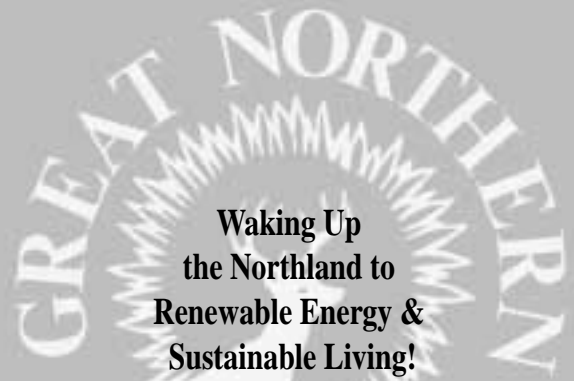

**Waking Up
the Northland to
Renewable Energy &
Sustainable Living!**

Bringing the finest in technology, equipment, and
knowledge to the northern midwest.

Solarex & Kyocera photovoltaic modules

Trace & Heart inverters
controllers, meters & more!

Great Northern Solar

SOLAR



Route 1 Box 71, Port Wing, WI 54865

(715) 774-3374

e-mail: gosolar@bucky.win.bright.net

Market your solar products to over 180,000 users!



Home Power connects you with a worldwide network of solar-active people. Consider this, 43% of *Home Power* readers own PV modules and 53% are planning on purchasing new modules. 31% of our readers are planning on purchasing solar water heaters. 47% are planning on buying inverters, 46% new batteries.

During 2000, *Home Power Magazine* readers will spend over 160 million dollars on solar equipment and services.

If you are looking for an active market for your products, *Home Power* can help your business. Call for a free sample issue and advertising information.



Home Power Magazine

PO Box 520

Ashland, OR 97520 USA

530-475-3179 voice

Web: www.homepower.com

Internet email: richard.perez@homepower.com

If you're not reading
Home Power magazine...
you're still in the dark.

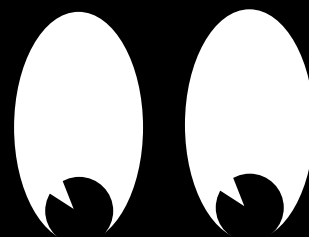

HOME POWER

THE HANDS-ON JOURNAL OF HOME-MADE POWER

800-707-6585

www.homepower.com

Writing for Home Power Magazine

Home Power is a user's technical journal. We specialize in hands-on, practical information about small-scale renewable energy systems. We try to present technical material in an easy to understand and easy to use format. Here are some guidelines for getting your RE experiences printed in *Home Power*.

Informational Content

Please include all the details! Be specific! We are more interested in specific information than in general information. Write from your direct experience—*Home Power* is hands-on! Articles must be detailed enough so that our readers can actually use the information.

Article Style and Length

Home Power articles can be between 350 and 5,000 words. Length depends on what you have to say. Say it in as few words as possible. We prefer simple declarative sentences which are short (less than fifteen words) and to the point. We like the generous use of subheadings to organize the information. We highly recommend writing from within an outline. Check out articles printed in *Home Power*. After you've studied a few, you will get the feeling of our style. System articles must contain a schematic drawing showing all wiring, a load table, and a cost table. Please send a double spaced, typewritten, or printed copy if possible. If not, please print.

Written Release

If you are writing about someone else's system or project, we require a written release from the owner or other principal before we can consider printing the article. This will help us respect the privacy rights of individuals.

Editing

We reserve the right to edit all articles for accuracy, length, content, and basic English. We will try to do the minimum editing possible. You can help by keeping

your sentences short and simple. We get over three times more articles submitted than we can print. The most useful, specific, and organized get published first.

Photographs

We can work from any photographic print, slide, or negative. We prefer 4 by 6 inch color prints with no fingerprints or scratches. Do not write on the back of your photographs. Please provide a caption and photo credit for each photo.

Line Art

We can work from your camera-ready art, scan your art into our computers, or redraw your art in our computer. We often redraw art from the author's rough sketches. If you wish to submit a computer file of a schematic or other line art, please call or email us first.

Got a Computer?

Send us the text for your article on 3.5 inch computer floppy diskette, either Mac or IBM format. We can also read ZIP disks (either Mac or IBM), Magneto-Optical disks (128 MB, 230 MB, 1.2 GB, and 1.3 GB, all Mac only), and CD-ROMs. This saves time and reduces typos. Please also send a hard copy printout of your article. Save all word processor files in "TEXT" or "ASCII TEXT" format. This means removing all word processor formatting and graphics. Use your "Save As Text" option from within your word processor. Please don't just rename the file as "text" because it will still include unreadable (at least to us) word processor formatting.

You can send your article via Internet to richard.perez@homepower.com as an enclosed ASCII TEXT file. If you are sending graphics, or articles with embedded graphics, then use this special email address: ben.root@homepower.com

It is wise to telephone or email ahead of electronic file submission. This is particularly true concerning graphics files. There are many, many, many ducks and they all need to be in a row....

Got any questions? Give us a call Monday through Friday from 9–5 Pacific Time and ask. This saves everyone's time.

Access

Richard Perez, Home Power magazine, PO Box 520,
Ashland, OR 97520 USA • 530-475-3179
Fax: 530-475-0836 (24 hours a day)
richard.perez@homepower.com
www.homepower.com



Q&A

Out of Time

Hello *Home Power*, I'm wondering if the PV folks are taking a close enough look at Y2K and embedded systems. The Y2K problem seems to have a software problem and a hardware aspect. On the hardware side, the date problem is printed in the layers of the chips. That's why MasterCard spent \$300 million to get compliant.

When I go to the local solar dealer, his phone is ringing off the hook! But he doesn't really know if his equipment will run or not. While I'm not a tech person, I hope that we don't have a pile of useless junk. Watch out for all transistors, especially time sensitive chips and LED readouts. Lots of luck, Aaron McKinnon, Eastsound, Washington

Hello Aaron. The Y2K problem is a software problem. Most RE gear doesn't use software. RE devices which are computerized and do use software don't have a clue about the date, much less the year. We've tested everything we can get our hands on and we've yet to find a single piece of RE gear that will be affected by Y2K-type problems. RE gear just doesn't use code-embedded chips or software that keep track of dates. Richard Perez

Solar Position Calculations

Hi! I am an amateur inventor and I'm trying to design an inexpensive solar tracker. My main problem is finding the formulas to calculate the position of the sun given the solar time and the latitude and longitude. Can you help me? Thank you in advance, Charles Hickman charlesh@webhart.com

Hi Charles, Homebrewing is a noble endeavor. Sun path charts are readily available for any latitude and every month (look for old books on passive solar at the library). A great article PV module positioning is PV Module Angles, by Richard Perez and Sam Coleman in HP36.

However, I am concerned that you are approaching this the hard way. Any clock-style sun tracker would have to be custom set for the location, latitude, and time of year. You are trying to second guess the path of the sun, then build an instrument to simulate it. Sounds tough.

The two kinds of trackers available commercially use different approaches. The first, often called a thermal tracker, uses freon. Two connected chambers of freon are heated by the sun. The system uses gravity to balance the PV rack as the freon equalizes its liquid to

gas ratio between each chamber. This system works on a single axis, east-west only. This is called the solar azimuth. Declination (elevation, or the angle of the sun from horizontal) must be set by hand, usually seasonally. This is how Zomeworks trackers work.

The second type of tracker uses photocells to literally follow the sun, or whatever the brightest spot in the sky is. A small Washington Monument-shaped pointer is set perpendicular to the plane of the PV panels. Photo cells are set on all four sides of the base of this obelisk. When it is not pointing directly at the sun, it will shade one or more of those cells. This electronically triggers the actuators, adjusting the PV rack back into a position where all four cells are receiving equal sun. This technique pays no attention to where the sun "should" be. Rather, it follows the sun wherever it is. This is how the Wattsun trackers by Array Technologies work. They are accurate on both the declination and azimuth axes within 1/4 of a degree. Not bad, and the initial positioning is less critical than with your clock-type design.

Don't be discouraged though. Home-built trackers are a reality. See John Millard's article in HP73, page 28, for some real creativity. Also see the article about Walther Vogel's system and his home-built gas trackers on page 6 in HP56. Happy tracking. Ben Root

Battery Electrolyte Stratification

1. I've heard of problems in lead-acid batteries with the electrolyte (sulfuric acid?) settling down to the bottom of the battery casing. Is this really a problem, and if so, how can it be resolved? Would this give false readings on a hydrometer?

2. I have a forklift battery that I use in my 24 volt system (2 V cells). What is a reasonable equalization voltage to set on my Trace C40?

I really was listening to your great presentation on batteries at MREF this year, but probably missed this info. Thanks in advance! John Manus, Greenbrier, AR

Hello John. 1. This is a temporary condition known as stratification of the electrolyte. The electrolyte that is richer in sulfuric acid settles to the bottom of the cells and the less rich electrolyte rises to the top. The cure is simple and easy. Give the cells an equalizing charge. This will cause the cells to gas radically, which stirs up the electrolyte. Stratification of the electrolyte will cause low readings on the hydrometer since you are sampling the less dense electrolyte at the top of the cells.

2. If the cells are between 65 and 75°F, then I'd set the equalization voltage at 31.5 VDC. If the cells are below 65°F, then I'd raise this voltage to 32–33 VDC. Remember that an equalizing charge is a controlled overcharge of an already fully recharged battery. You

should be equalizing your cells every five to seven deep cycles or every three to four months, whichever comes first. Maximum charge rate during equalization is C/20.

I'm glad you enjoyed the battery workshop at MREF. It's a lot of information to absorb in an hour and a half. This info and more is on our Solar4 CD-ROM. Holler if you have any more questions regarding your battery. Winter is coming on and this is the toughest season for batteries. Sunlight is in short supply and temperatures are low. Remember to do the equalizing charges and the battery will work better and last longer. Richard Perez

Mod Sine Circuit for Battery Charging

I am interested in using a Trace inverter in my utility power fed home. I want my batteries to be the main source of power and when they get too low, have the Trace supply grid power to the loads and charge the batteries. The less expensive Trace inverters don't allow this, only the very expensive SW series does this. Do you have a circuit design that would allow me to only connect the AC to the Trace when the battery power is too low? It seems that it could be done with a transistor, some resistors, and a few relays. Thanks for your interest! Sincerely, Dan Russell, icc3@ix.netcom.com

Hello Dan. Sorry, but I've never needed this circuit and so have never designed one. All my time on those chargers has been using a generator as the 120 VAC source. But, since you sound like you know what a transistor is and how it works... I'd use a voltage sensing IC like the LM723 to one-shot gate a transistor, which would in turn close a relay, which would connect the Trace's charger to the grid.

This is a very simple circuit. It needs a manual disconnect, or a second voltage sensing circuit to disconnect the charger and reset the circuit when the batteries are fully recharged. The circuit needs to be very reliable because you don't want to fry your batteries when you aren't home to watch them. Sounds like it's getting more complicated... How about it, readers? Anyone have a good circuit to automate the battery charger on U and DR series Traces?

Incidentally, you've missed the central point about inverters—power quality. The SW series are worth the extra money over a mod sine inverter for power quality reasons alone. Add to that efficiency, advanced control features (like the ones you want), and the ability to utility intertie, and the price might not seem so high.

I spent ten years running many mod sine inverters on a wide variety of loads. I've been using only sinewave inverters for about the last five years. I'll never go back. All the electric motors run faster, cooler, and with less power consumption. All reactive loads work better. And sinewave inverters also allow us to run devices using electronic power control—laser printers, vacuum cleaners, light dimmers, cordless appliance chargers, and many other appliances. Richard Perez



HELIOTROPE GENERAL

Since 1974, products for solar applications.



PV Charge Controllers

from the originator of Pulse Width Modulation (PWM).

- 15 to 120 Amps
- Batteries stay at higher SOC
- Less battery water replacement
- Temperature compensation is standard
- Solpan™ power centers
- Testing Lab listed by ETL

.....

Thermal DHW system components and pool control systems.

- Solar Sidebar is the highest performing DHW system and is PV powered
- Delta-T® is reliability proven in nearly one million installations
- Sensors are lifetime guaranteed



Heliotrope General and its employees are dedicated to using solar.

The name means reliability

HELIOTROPE GENERAL

1-800-552-8838

3733 Kenora Dr.
Spring Valley, CA 91977
(619) 460-3930
Fax (619) 460-9211

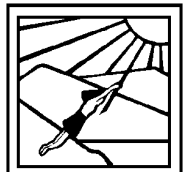

website: www.hg1.com
e-mail: heliotrope@hg1.com



Home Power MicroAds



Rates: 10¢ per CHARACTER, including spaces and punctuation. \$15 minimum per insertion. Please send a check with your ad. Your cancelled check is your receipt.

Help us prevent fraud! *Home Power* MicroAds from individuals must supply serial number(s) for equipment being sold. Businesses must supply a published phone number(s) and a physical address. If at all possible, please pay for your ad via personal or business check or credit card.

While *Home Power* is doing everything we can to prevent fraud, we can assume no responsibility for items being sold.

PURE CASTILE & VEGETARIAN SOAPS. Handmade in an AE environment. We also have hard to find natural bath & body care products. FREE catalog: SIMMONS HANDCRAFTS 42295 AE, Hwy 36, Bridgeville, CA 95526

HYDROELECTRIC SYSTEMS: Pelton and Crossflow designs, either complete turbines or complete systems. Assistance in site evaluation and equipment selection. Sizes from 100 watts to 5 megawatts. Manufacturing home and commercial size turbines since 1976. Send for a free brochure. Canyon Industries Inc., P.O. Box 574 HP, Deming, WA 98244, 360-592-5552.

XXXXXXXXXX USED SOLAR MODULES XXXXXXXXXXXX
XXXXXXXXXXXXXXXXX 64 Watts \$319 XXXXXXXXXXXXXXXX
Used MSX60s \$295, BZ 8 amp pwm controller \$49, Ex 2KW inverter SB, 110 amp charger New \$850, 3000+ watt resistors \$35, new 75 Watt modules \$375. Buy, sell New/Used, Trace, NiCds, refrigerator. Try to match anyone's prices. Call or send S.A.S.E. to Craig Eversole, 10192 Choiceana, Hesperia CA 92345 for free flyer. M/C VISA Discover 760-949-0505

The big-box Solar Mart may talk a good game from behind the order desk, but are they actually out there doin' it? VERMONT SOLAR ENGINEERING takes pride in being a reality-based dealer/designer/installer. We know the products because we work with them every day—PV, hydro, wind & domestic hot water, from components to complete systems. So reject the romantic salespeak offered by the volume dealers and give us a call. Thanks! 800-286-1252, 802-863-1202, 863-7908(fax). PO Box 697, Burlington, VT 05402. Our Website contains our installation portfolio and attractive sale pricing—www.vtsolar.com-Visa/MC

I AM A SOLAR WHOLESALER looking for retailers to carry my solar electronic and hobby goods. Phone # (916) 486-4373. Please leave message.

START YOUR OWN TECHNICAL VENTURE! Don Lancaster's newly updated INCREDIBLE SECRET MONEY MACHINE II tells how. We now have autographed copies of the Guru's underground classic for \$18.50, Synergetics Press, Box 809-HP, Thatcher, AZ 85552. (520) 428-4073, VISA/MC.

RADIO/TELEPHONES FOR Remote Home or Business: Commercial quality, up to 20+ mi, Best Prices. (208-263-9755 PST) Send \$1 cash: KRES, Box 215-HP, Kootenai, ID 83840

FOR SALE: Photocopied reprints of *Home Power* issues 1–10 available. All proceeds will be donated to IRENEW. Call 815-469-5334 or email Jeff_Green@msn.com. Sold only in sets of 1 thru 10 for US\$30 which includes shipping in most cases.

INTERESTED IN INTENTIONAL COMMUNITY?

Communities magazine offers complete, updated listings of intentional communities not found in the Communities Directory. Practical information about forming/joining community — alternative buildings & structures; getting off the grid, legal, financial & land options. Plus Eco-villages, Cohousing, decision-making, conflict resolution, successful communities, children in community, research findings on community living. Quarterly. \$18/yr, \$5/sample. 138-HP Twin Oaks Rd, Louisa, VA 23093. (540) 894-5798.

YOUR ALASKAN SOLAR EXPERTS! Complete source for Alaskan alternative power. ABS Alaskan, 2130 Van Horn Road. Fairbanks, AK 99701 907/452-2002, AK 800/478-7145

EARTH-SHELTERED HOMES This definitive manual by noted authority Loren Impson features detailed building instructions for the amazingly affordable and practical Ferro-Cement Dome Home. Only \$15 from Sun Life, 71 Holistic Hollow, Mount Ida AR 71957

OVER 23 YEARS IN SOLAR Business. Talmage Solar Engineering, Inc. has served customers from the islands off the coast of Maine to Honduras. We take time to figure out the exact needs of each customer, design and engineer systems that will work and give the best possible price on equipment. Give us a chance to show that our experience will help you build a solar power system that will work. We are always here to give backup support. 18 Stone Rd. Kennebunkport, ME 04046 207-967-5945 E-mail tse@talmagesolar.com website www.talmagesolar.com

VERMONT PV DEALER. David Palumbo/Independent Power & Light has been installing off-grid systems, and helping do-it-yourselfers (who buy their equipment from him) with free professional design advice for over 10 yrs. Trojan and Surrette batteries. FREE with battery purchase IP&L deep cycle battery instructions. Trace, Solarex, Siemens, and BP at fair prices. Large supply of wire and cable. Beware of "fast buck artist," slick talking, "lowest price anywhere" mail order companies who don't take the time to find out what you really need and can't spend the time on personal support and service. Buy from an honest dealer who knows the products and cares about your success in using them. David's installations are innovative, simple to live with, and successful. And our long following of do-it-yourself customers always come back for more because they can rely on getting straight talk, no BS, and the best service possible. "David is one of the original RE pioneers... he knows how to really squeeze all the energy out of a KWH!" Richard Perez (*HP60*). I P & L, 462 Solar Way Drive, Hyde Park, Vermont 05655. Call David Palumbo 802-888-7194. Email: indeppower@aol.com. Web site: INDEPENDENT-POWER.COM. No catalog requests please. Please call for appointment before visiting.

EDUCATIONAL WINDMILL Kit. Only 8 inches tall, really produces electricity from a PM alternator you build! Add on kit teaches AC/DC conversion concepts. Perfect for Science Fairs, home schools, or adult hobbyists. Grade 5 to adult. Available only at www.picoturbine.com

ON SALE NOW: Power & Water System Components—A limited selection of the Very Best Buys. For Free Sale Catalog call or fax your address to 508-627-1319.

VERY LOW PRICES Solar Electric & Thermal Equip. Panels-Inverters, Charge regulators, wind generators-pumps-controls Please Call (888) 817-1737 or write to 6 Cresta Cir. #7, San Rafael, CA 94903

EDTA RESTORES SULFATED Batteries. EDTA tetrasodium salt, info, catalog, \$12/lb plus \$3.50 ship & handle. Trailhead Supply 325 E. 1165 N. Orem, UT 84057 email: trailheadsupply@webtv.net http://www.webspawner.com/users/trailheadsupply

STEAM ENGINE KIT, all materials with machining drawings or fully assembled. Power small boat, generator, or machinery. Information; 55¢ stamp to Pearl Engine Co, RR1 Box 45 Sutton VT 05867 • 802-467-3205 http://homepages.together.net/~pearleng

SOLAR POWER OF TEXAS. For the installation of complete solar systems we cover the entire state. We can deliver any home power equipment that's related to the industry. We offer Solarex MST 43 watt modules at 2.57 Amp 12 Volt for \$185 each when you purchase ten or more. We have many other great bargains. For more information you can reach us at 7711 Colony Rd. Tolar TX 76476 or 800-474-1160 or email gaf@itexas.net. You can also visit us at our Web site at www2.itexas.net/gaf/

FREE-ENERGY Video. Must see. \$35. 800-401-9492, PO Box 2355, Elk Grove, CA 95759

HUGH PIGGOTT'S Windpower Workshop book will teach you how to build a wind turbine. No other book like it. Hugh Piggott's Breakdrum Windmill Plans booklet has complete plans for making a wind turbine out of a junked van breakdrum. Built all over the world, proven design. Available in the USA only from www.picoturbine.com

FREE PROPERTY LIST for mountain land, some with creek or river frontage in beautiful Scott Valley, Northern California just 15 minutes west of Yreka off I-5. 5 to 320 acre parcels, perfect area for retirement or country lifestyle. Call Scott Valley Real Estate (530) 468-2252, www.svre.com

WANTED: The Midwest Renewable Energy Association is in need of two wind generator towers. We'd like Rohn SSV towers, one at 90' to 100', and the other at 110' to 120'. Donations always accepted. Please call Mick at 920-837-7523 or Katy at 715-592-6595.

WWW.PICOTURBINE.COM is your DIY renewable energy superstore! Free plans, discount books and videos, inexpensive kits for homebrew and education. There is no other web site like it! Build your own wind turbine, solar cell, solar cooker, fuel cell, or EV!

NEW ENGINEERING Tools to help with your calculations! Engineering Software Phone/Fax: 301-540-3605 http://members.aol.com/engware

LOW HEAD HYDROELECTRIC Plant on 65 acres in South Dakota. 100 kva & 250 kva generators. Some work needed. \$125,000 obo. 805-983-1072. kd6gw@aol.com

SOUTH CENTRAL VIRGINIA—Nice partially renovated home on 28 beautiful Ac, strong stream, dam, 20' head, 1kw potential, old mill and other buildings, privacy, super gardening. \$155,000 (804) 248-9205 jp@nurser.com

XXXXXXXXXXXXXXXX LP GAS FRIDGESXXXXXXXXXXXXXXXX DANBY 7.8 cu ft. \$899 (LP only), Servel Americana 8.0 cu. ft. \$1189 (LP & 120 vac), Conserv Freezer 7.5 cu. ft. \$599 (120 vac), Sun Mar Excel NE toilet \$899. Call 1-877-222-4990 (toll free)

SOLAREX MSX-60 \$297, 83 \$410, 120 \$595. US Battery 2200 6V@225AH \$54, L16HC@415AH \$148, \$10 premium on single PV or bat. Air 403 \$525. Conserve RF \$995, Fr \$598. Servel RG400 \$999, Frostek LP 8.5 Fr. \$1750. Reconditioned ElecTracs & attachments Info \$2. Call 'til 10:30PM ET for any A.E. need. 717-677-6721 V. Bream, 1755 Coon Rd., Aspers, PA 17304.

XXXXXXXXXXXXXXXX Air 403 \$499 XXXXXXXXXXXXXXXXXXXX World Power Technologies WPT 900 \$1599, WPT 1000 \$2489, WPT 3000 \$4889. Call 1-877-222-4990 (toll free)

ELECTRIC POWER YOUR BICYCLE. Henthorn Regenerative Electric Auto. Simple Homemade Hydrogen. Plans catalog \$1. DWFrench, POB 2010(AEHP), Sparks, NV 89432

USED 10KW Bergey Wind Gen w/80' tilt up tower & cables \$12,500 OBO 414-646-4664

XXXXXXXX\$3.99/Watt Photowatt 100 Watt \$399XXXXXX Photowatt 75 watt \$319, BP275 \$349, BP585 \$419, MSX60 \$306, SP75 \$379, SR100 \$519., Uni-Solar US 64 \$309, Astro Power 120 watt \$559. Call 1-877-222-4990 (toll free)

I HAVE "ONE" 10 KW Jacobs Smooth case with 70' Rohn tower. 21' ft wood blades. Utility inverter or offgrid + tax + ship Price starts \$9000 Palouse Wind & Water 208-883-3676

SEATTLE—AREA: Off-grid solar cedar home on 31 acres, privacy and mountain views. Visit at www.halcyon.com/alancrab/re.htm (alancrab@halcyon.com) or POB 314, Arlington, WA 98223

XXXXXXXXXXXXXXXXTrace SW4024 \$2,399XXXXXXXXXX DR 3624 \$1139, DR2424 & DR 2412 \$959, DR1524 & DR 1512 \$699, PP-SW4024/S \$3399, PP-SW 4024/D \$5999, Trace C40 \$149. Call 1-877-222-4990 (toll free)

FRIENDLY WOOL MACHINES! Non-itchy Llama fiber, turn weeds into Apparel. \$800 Young male, \$1200 Trail Pro, \$1800 Breed Female, \$7200 Female 1998 Grand Champion! Fur sample \$5, Cottonwood Ranch 1111 Hwy 339, Yerington NV 89447. Micro Camels, Soft, Warm and Fuzzy

PRIMITIVE Y2K PROPERTY 20 acres Washington, walk to Canada, wilderness areas, lakes. Isolated, open views, trees, beautiful, 3 wells, 1152 sq.ft. pole building, living area/shop, cedar siding, metal roof. Outhouse. 39K/best. 530-598-1955

WHISPER H 1500 HV/LV. Includes EZ Wire Centre and Transformer. Heartland, Woodburning Cookstove (Oval Model) New—in original shipping containers. tel/fax 831-479-8155, kb53@earthlink.net

GENERATOR 12 Volt, 55 Amp, 900 RPM heavy-duty, built for and like a tank. Two belt pulley, fan mounting bracket and voltage regulator. New \$1650 shipping weight 100 lbs. Tri Anchor Marine, 3665 Haven Avenue, Menlo Park, CA 94025, 650-368-3001

Y2K SPECIALS: Now offering the worlds Lowest prices Save 5%–50% off marked down prices. From solar modules to inverters to accessories on all top name brands such as Trace, Heart Interface, UniSolar, Siemens, Statpower, Kyocera and Whisper to name a few. Call toll free 877-246-8217 M/C Visa. Visit our website <http://www.solartech2000.com>

COLORADO REAL ESTATE Great solar community, just west of Metro Denver area. 3bdrm, 2400 SF home on 3.75 acres in National Forest. Extremely energy efficient. Great solar setup, fantastic views. \$259,900. Custom log home on 8+ acres in National Forest. Energy efficient, terrific solar system. 3bdrm, 3ba, unbelievable views! \$350,000. 40 acre building site with great alternative energy possibilities \$169,900. All three in areas where wildlife abounds, but access to city is great. For more information call Jaye Riley, Colorado Preferred Real Estate, LLC 888/313-1169, jriley10@aol.com or website [welcometocolorado.com](http://www.welcometocolorado.com)

CABO SAN LUCAS, Baja, Cal. Lg. 4 level, solar off-grid home with bodega and extra lg. 2 car (or boat) garage. 3 bedroom, 2 bath. 1.5 mi from town. 360° views! \$170,000 208-265-2540

PACIFIC INVERTER 3 kW grid tied use only 48VDC 240VDC \$200; 122' Rohn 45 GSR tower with guy wires and turnbuckles good for 10 kW Bergey Excel or smaller wind turbine \$2,000. 603-783-4712

LED ILLUMINATION LED lighting products including flashlights and arrays. For free information, write to Noctilume, P.O. Box 3042, Culver City, CA 90231. Telephone: (310)-967-4719 website: <http://www.imall.com/stores/noctilume>

HOME POWER COLLECTION of back issues, #s 1–68, in great shape, sell whole set only \$180 OBO, shipped within U.S. 323-469-7041, cprf@jps.net—email preferred.

DON'T BUY NEW Batteries Yet! @ EDTA (Tetrasodium salt of ethylenediaminetetraacetic acid tetrahydrate)—Used to dissolve sulfate deposits from lead acid batteries, recovering otherwise unuseable ones thus preventing the purchase of new batteries. 1–2 Tablespoons per cell (instructions included) for up to 3 treatments. 2 lbs. for \$19.95 plus \$5.00 shipping & handling. Visa & Mastercard accepted. To order call toll free 877-337-2490. Aurora Power & Design, 3412 N. 36th, Boise, ID 83703.

COMPUTER NERD WANTED: Work/study trade opportunity. 6–12 months “Hands-On” workshop attendance in exchange for “net savvy”, multi-media skills in IBM PC environment. Solar Energy International, 970-963-8855 sei@solarenergy.org (For SEI info see *HP ad*)

SUNFROST ref/fr Mdl RF-16, 120V w/left hinge & 13" drawer base. 1-year old. MINT. One owner; very, very clean. Factory price is over \$2,500. Ready to go at \$1,650 firm. Dave Lahar 3589 Burton Hill Rd, Barton, VT 05822, 802-754-2318.

GUN CONTROL, “everything you wanted to know & preachers were afraid to tell you”. Only \$2.00. Catalog of politically incorrect books \$1.00. Bohica Concepts, POB 546, dept. HP, Randle, WA 98377

FOR SALE: BEAT Y2K, Sierra Vista (southeast) Arizona, totally solar, adobe home, 15 acres, 360 degree mountain views, call (520)803-1776 or email pglenn@theriver.com

SUNFROST REFRIGERATOR 12VDC, works very well, two compressors and new electronics, underneath storage cabinet, interior shelves and voltmeter. Walnut Veneer, custom sized model RF-16, approx. ten yrs old \$1800 obo. Available now at Six Rivers Solar in Eureka, CA. call Greg (707) 444-9277 9-noon

NEW TELEDYNE thermoelectric generator costs over 14K, can be used for 12V or 24V applications, \$750.00 415-388-0838

SIMPLE ELECTRIC Do-It-Yourself Gate Opener Plans \$6.00; No more lawn mower flats. Details \$2.00; Useful Plans, P.O. Box 1183, Russellville, AL 35653

LOOKING FOR A Full-3/4 time licensed journeyman electrician for 12 yr. old solar business. Orcas, WA (360) 376-5336

PROPANE REFRIGERATOR Consul, works well, could use inner door panel \$300 OBO, FOB Arcata, CA 707-822-7884 michael.welch@homepower.com

Prescott - AZ - Attractive (5'6"), slim, healthy, Solar Lady looking for a soul mate (ages 45-55) to share a Purpose that God has for us. As a steward, I promote solar energy; living it & through business. Love writing/producing music in my studio. Background in nursing; now into alternative medicine & living the good life of gr.house gardening, cooking, dancing, painting, pottery, stain glass, ham radio, flying, electric cars etc! I like to be feminine and be a helpmate to a man I can look up to. If you are warm, caring, affectionate and like doing honey do's now and then plus having a full life of fun, travel, adventure, and a man of God, please write! A man who is into electronics is a plus. Flexible in relocation/changes harmony@mwaz.com

INTERNS WANTED at SOLAR ENERGY INTERNATIONAL! Work/study trade opportunities. 6–12 months “Hands-On” workshop attendance in exchange for multi-faceted office work, beginning ASAP. SEI, Carbondale, CO sei@solarenergy.org (970) 963-8855 (For SEI info see *HP ad*)

CHINESE DIESEL GENERATORS. 10 KW, 115/230 volt, 60 Hz@1800 RPM, Water cooled, electric start, Old style heavy, brush alternators, 3 hours per gallon, average home use. Tool kit, overhaul parts, \$3095.00 + freight. Other sizes available. Voice 315-628-0601, Fax 315-628-5797, Email ellison@gisco.net

ANTI-BACTERIAL Tea Tree Honey for sale. Used for sore throats, colds, canker sores, fever blisters & stomach ulcers. Call 800 395 2196. www.frontierproducts.com



Index to Advertisers

- aatec publications — 139
Abraham Solar Equipment — 121
Adopt a Library — 150
Advanced Composting Systems — 135
Alternative Energy Engineering — 17
Alternative Energy Store — 78
AlternativeEnergySystemsCo — 50
Alternative Solar Products — 42
AstroPower — 43
BackHome — 136
Backwards to the Future — 70
Backwoods Solar Electric Systems — 58
BargainSolar.com — 91
Bell Solar International Inc — 130
Bergey Windpower — 41 & 83
Bogart Engineering — 115
Bornay Windturbines — 92
Bowers Power Systems — 121
BP Solar — 2
Brand Electronics — 111
BZ Products — 130 & 136
C. Crane Company — 141
C.C. Solar Technologies — 126
Canrom Photovoltaics Inc — 127
China Diesel — 49
Creative Energy Technologies — 117
Dankoff Solar Products — 82
Delivered Solutions — IBC
Dyno Battery — 72
Eklektix — 141
Electro Automotive — 126 & 141
Electron Connection — 87
Energy Conservation Services — 84
Energy Outfitters — 131
Energy Systems & Design — 129
EPOWER — 130
ETA Engineering Inc — 117
Exeltech — 48
Feather River Solar Electric — 90
FireWind&Rain — 71
GenSun Integrated Solar Electric Systems — 86
Global Power Systems — 84
Great Northern Solar — 153
Greenshelf — 130
Guerrilla Solar T-shirts — 109
H-Ion Solar Inc — 153
Harris Hydroelectric — 136
Heart Interface — 1
Heaven's Flame — 92
Heliotrope General — 156
Hitney Solar Products — 121
Home Power Back Issues — 140
Home Power Biz Page — 81
Home Power CD-ROMs — 102
Home Power Sub Form — 80
Home Power T-shirts — 109
Home Power Millennium Specials — 93
Horizon Industries — 135
Hot Products Inc — 125
Hydrocap — 129
Intermountain Solar Technologies — 73
International Carbon Bank & Exchange — 130
Invertrix Inc — 80
Jack Rabbit Energy Systems — 108
KTA Services Inc — 117
Kyocera Solar Inc — 59 & OBC
Lake Superior Renewable Energy — 141
Low Keep Refrigeration — 130
Maple State Battery — 16
MHS Solar — 135
Morningstar — 39
MREA Workshops — 100
MREF/ASES — 103
Natural Energy Systems — 131
NESEA — 135
New Electric Vehicles — 102
New England Solar Electric Inc — 131
New England Solar Homes — 16
Newinli International Inc — 82
Northern Arizona Wind & Sun — 115
Northwest Energy Storage — 79
Offline — 135
Palouse Wind & Water — 120
Planetary Systems — 91
Pony Enterprises — 139
Quick Start REading Special — 150
RAE Storage Batteries — 141
RCH Fan Works — 121
Read Your Mailing Label — 109
Refrigeration Parts Solution — 126
Renewable Energy Videos — 100
Rolls Battery Engineering — 58
RV Power Products — 32
Sensible Steam — 141
Siemens Solar Industries — 31
Simmons Handcrafts — 150
Snorkel Stove Company — 110
Solar 4 U Inc — 100
Solar Converters Inc — 114
Solar Depot — IFC
Solar Electric Inc — 116
Solar Energy International — 101
Solar On Sale — 110
Solar Pathfinder — 135
Solar Plexus — 92
Solar Village Institute — 56
Solar Webb Inc — 127
Solar Works Inc — 114
Solarex — 23
SolarRoofs.com — 130
SolarSense.com — 7
Solec — 51
Soltek — 110
Southwest Windpower — 18 & 127
Spectacle Technology — 136
Statement of Ownership — 150
Sun Frost — 91
SunAmp Power Company — 117
Sunburst Solar Products — 114
Sunelco — 40
Sunlight Energy Corp — 92
SunLine Solar — 111
Sunweaver — 30
SunWize Technologies Inc — 80
Surrette Battery Company Ltd — 90
Trace Engineering — 32 & 57
Trojan — 22
Two Seas Metalworks — 65
U.S. Battery — 64
Vanner Power Systems — 86
Vermont Solar Engineering — 126
Wattsun (Array Tech Inc) — 131
Windstream Power Systems Inc — 120
World Power Technologies — 32 & 33
Zomeworks — 127





HOME POWER

THE HANDS-ON JOURNAL OF HOME-MADE POWER

ISSUE #74

December 1999 / January 2000

\$4.75 U.S.

\$7.00 CAN.

Display until February 1

*Renewable Energy
in an Island Community*

High School Solar on Wheels

*Solar-Powered Health Clinic
in Nicaragua*

*Data Logging
Your Energy System*

*Boating Finland
on Solar Power*

*Wind Generator
Factory Tour*

*Design Tips from a
Wind Power Guru*

*Electric Vehicle Batteries
Part 2*

*PLUS: The Invaluable,
Essential, & Ultimate
Y2K Preparedness
Do-It-Yourself Project*

WHAT DO YOU WANT?

- Pre-Packaged Solar Electric Systems
- Easy-To-Install, Hassle-Free Systems
- Great Prices
- Engineered & Partially Pre-assembled
- Code Compliant Systems
- Easy-to-follow Installation Manual
- Technical Assistance Provided
- Owner-Builder Discounts



- PV Panels
- Batteries
- Regulators
- Inverters
- Switchgear
- Wind Generators
- Solar Water Heaters

WE FIGURED YOU WOULD!

SO WE MADE:



- Utility-Connected Models
- Off-Grid, Stand-Alone Models
- Hybrid Models with Wind or Hydro



ATTRACTIVE DEALER DISCOUNTS



Checkout our on-line catalog at
www.solardepot.com/pvcatalog/index.html



WE ARE



Solar-Depot-San Rafael
61 Paul Drive
San Rafael, CA, 94903

email staff@solardepot.com

(415) 499-1333

Fax (415) 499-0316

Orderline (800) 822-4041



Solar Depot-Sacramento
8605 Folsom Blvd.
Sacramento, CA, 95826
email soldrpo@calweb.com
(916) 381-0235
Fax (916) 381-2603
Orderline (800) 321-0101



SOLAR ELECTRIC DEALERS

Why buy from a distributor when you can purchase modules direct from the factory?

Why buy an oil company's product when you can purchase from a truly green company?

Why accept less than a 25 year warranty?

Why buy any other module?



KYOCERA SOLAR, INC.

**7812 EAST ACOMA DRIVE
SCOTTSDALE, AZ 85260**

480/951-6330

800/544-6466

FAX 480/951-6329

www.kyocerasolar.com



Home Power Subscription

\$22.50 per year (6 issues) to U.S. Zip codes via 2nd Class U.S. Mail
 \$36.00 per year (6 issues) to U.S. Zip codes via 1st Class U.S. Mail
 \$30.00 (U.S. drawn on U.S. Bank) International Surface Mail, see pg. 81 for Air Rates
Home Power Magazine, PO Box 520, Ashland, OR 97520
Subscribe on line at: www.homepower.com
Subscriptions: 800-707-6585 (inside USA) or 541-512-0201 or FAX 541-512-0343
Editorial and Advertising: 530-475-3179 or FAX 530-475-0836

To subscribe to Home Power, please fill out the sub form below, enclose payment as a check, money order, or Visa/MasterCard, and mail this form. Tape the form well or use an envelope so your check doesn't fall out. Your sub or renewal will start with HP's next regularly scheduled issue. Please allow up to ten weeks for the start of your 2nd class sub. For those wishing **International Subscriptions or Back Issues of Home Power, please see page 81.**

New 2nd Class Sub-\$22.50 to USA Zip Codes New 1st Class Sub-\$36 to USA Zip Codes Sub Renewal Specify 1st or 2nd Class Change of Address Include Old Address

Gift subscription
 From (give your name and address here) _____

DO YOU WANT US TO SEND YOU A SUBSCRIPTION RENEWAL NOTICE?

The number of the last issue in your subscription is printed on your mailing label.

Yes, remind me by mail when my subscription runs out. No, I'll check my mailing label so we can save energy & paper.

PLEASE CLEARLY PRINT BELOW THE COMPLETE NAME AND ADDRESS FOR THIS SUBSCRIPTION

NAME _____

STREET _____

CITY _____ STATE _____ ZIP _____

PHONE _____ E-MAIL _____

 **Credit Card Orders:** please check the type of card you have and fill in the information below.
 Signature (as shown on Card) _____ Exp. Date _____

 Credit Card Number _____ Amount \$ _____

The following information about your renewable energy usage helps us produce a magazine which better serves your interests. This information will be held confidential. We do not sell our mailing list. Completion of the rest of this form is not necessary to receive a subscription, but we would greatly appreciate your input.

NOW: I use renewable energy for (check ones that best describe your situation)

- All electricity
- Most electricity
- Some electricity
- Backup electricity
- Recreational electricity (RVs, boats, camping,)
- Vacation or second home electricity
- Transportation power (electric vehicles)
- Water heating
- Space heating
- Business electricity

In The FUTURE: I plan to use renewable energy for (check ones that best describe your situation)

- All electricity
- Most electricity
- Some electricity
- Backup electricity
- Recreational electricity (RVs, boats, camping,)
- Vacation or second home electricity
- Transportation power (electric vehicles)
- Water heating
- Space heating
- Business electricity

RESOURCES: My site(s) have the following renewable energy resources (check all that apply)

- Solar power
- Wind power
- Hydro power
- Biomass
- Geothermal power
- Tidal power
- Other renewable energy resource (explain)

The GRID: (check all that apply)

- I have the utility grid at my location.
- I pay _____¢ for grid electricity (cents per kiloWatt-hour).
- _____% of my total electricity is purchased from the grid.
- I sell my excess electricity to the grid.
- The grid pays me _____¢ for electricity (cents per KiloWatt-hour).

(continued on reverse)

I now use, or plan to use in the future, the following renewable energy equipment (check all that apply).

| NOW | FUTURE | | NOW | FUTURE | |
|--------------------------|--------------------------|-------------------------|--------------------------|--------------------------|--------------------------------|
| <input type="checkbox"/> | <input type="checkbox"/> | Photovoltaic modules | <input type="checkbox"/> | <input type="checkbox"/> | Methane digester |
| <input type="checkbox"/> | <input type="checkbox"/> | Wind generator | <input type="checkbox"/> | <input type="checkbox"/> | Thermoelectric generator |
| <input type="checkbox"/> | <input type="checkbox"/> | Hydroelectric generator | <input type="checkbox"/> | <input type="checkbox"/> | Solar oven or cooker |
| <input type="checkbox"/> | <input type="checkbox"/> | Battery charger | <input type="checkbox"/> | <input type="checkbox"/> | Solar water heater |
| <input type="checkbox"/> | <input type="checkbox"/> | Instrumentation | <input type="checkbox"/> | <input type="checkbox"/> | Wood-fired water heater |
| <input type="checkbox"/> | <input type="checkbox"/> | Batteries | <input type="checkbox"/> | <input type="checkbox"/> | Solar space heating system |
| <input type="checkbox"/> | <input type="checkbox"/> | Inverter | <input type="checkbox"/> | <input type="checkbox"/> | Hydrogen cells (electrolyzers) |
| <input type="checkbox"/> | <input type="checkbox"/> | Controls | <input type="checkbox"/> | <input type="checkbox"/> | Fuel cells |
| <input type="checkbox"/> | <input type="checkbox"/> | PV tracker | <input type="checkbox"/> | <input type="checkbox"/> | RE-powered water pump |
| <input type="checkbox"/> | <input type="checkbox"/> | Engine/generator | <input type="checkbox"/> | <input type="checkbox"/> | Electric vehicle |

FOLD HERE AND TAPE EDGES

Please write to us here. Tell us what you like and don't like about Home Power. Tell us what you would like to read about in future issues. Thanks for your attention and support.

Check here if it is OK to print your comments as a letter to Home Power.

FOLD HERE AND TAPE EDGES

Return Address



Home Power Magazine
Post Office Box 520
Ashland, OR 97520